

 **angel cerdá**

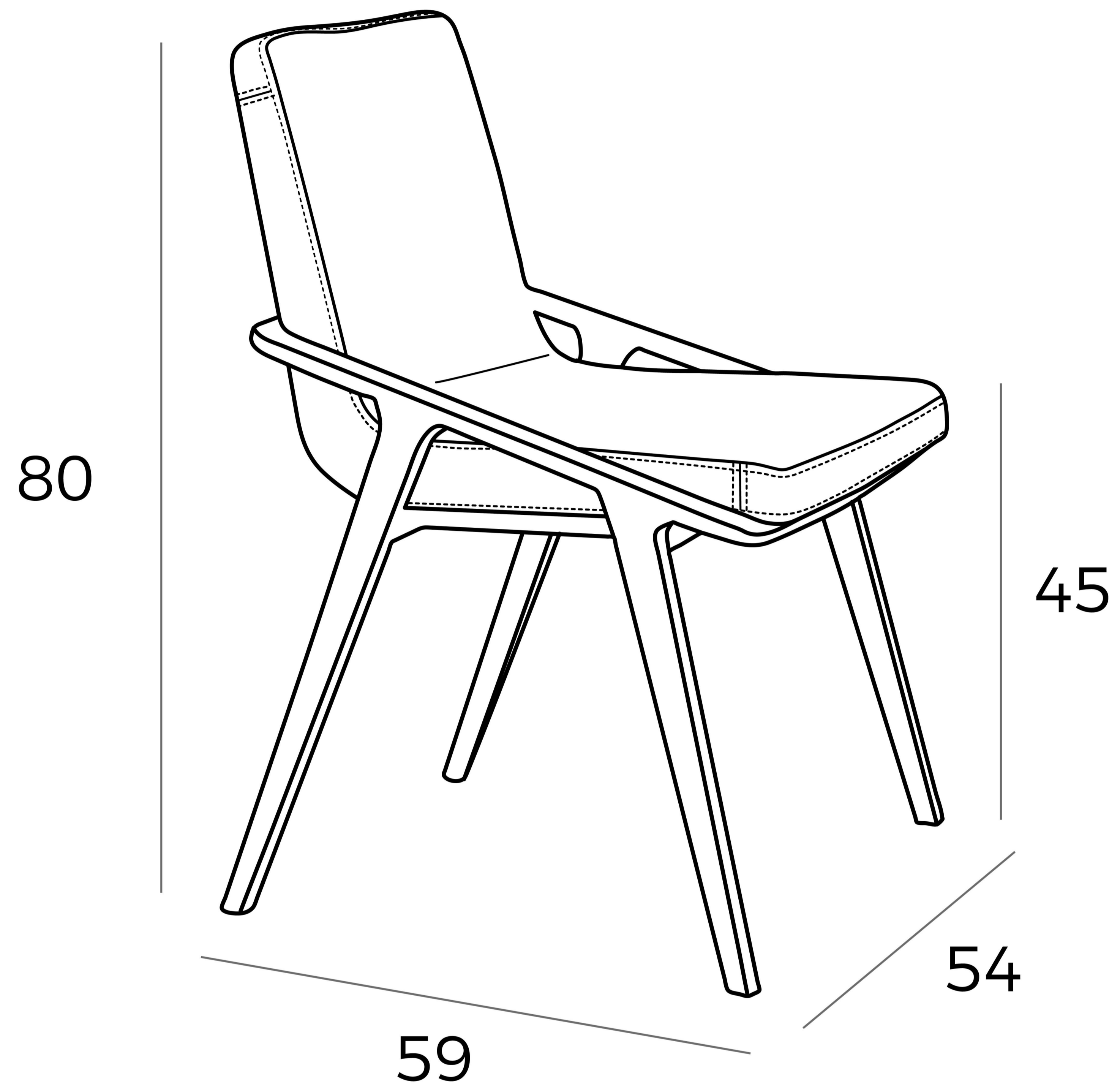

**PACK
2**



54 x 59 x 80 cm.
16,5 kg.

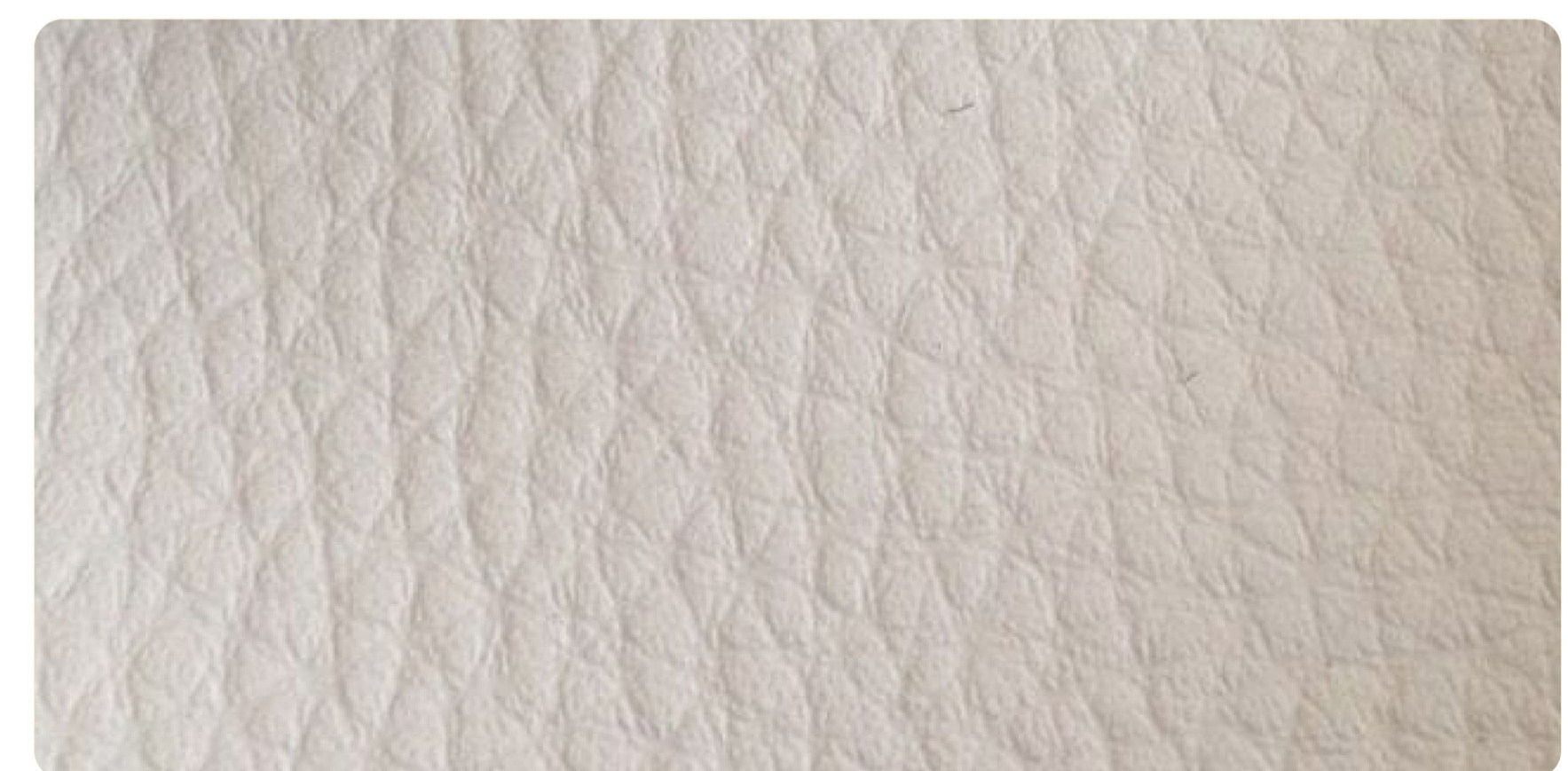
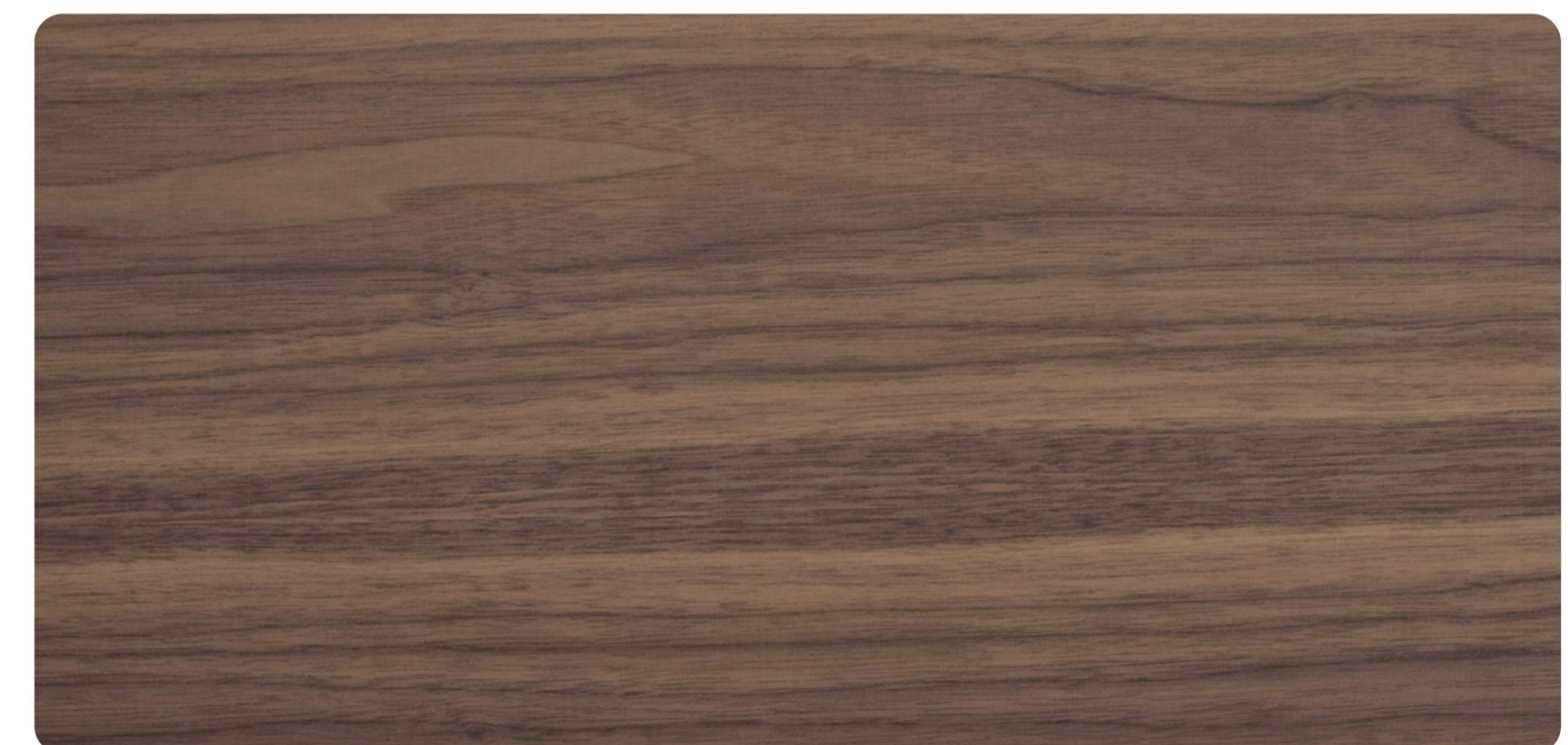

 59 x 67 x 88 cm.  34 kg.