

SHOWER

ZD1050











Colonna doccia completa di termostatico esterno. / Shower column with exposed thermostatic mixer.



Colonna doccia completa di termostatico esterno, soffione Z94265 e doccetta in ottone Z94177 a getto fisso.

Shower column with exposed thermostatic mixer, Z94265 shower head and brass handshower simple jet Z94177.

Finiture / Finishes

	 C3	 C8	 C40	 C41	 C50	 C51
Cromo / Chrome	Nickel Spazzolato / Brushed Nickel	Nickel Lucido / Polished Nickel	Oro / Gold	Oro spazzolato / Brushed Gold	Metal Black / Metal Black	Metal Black spazzolato / Brushed Metal Black
 W1	 N1	 N7				
Bianco Opaco Goffrato / Embossed Matt White	Nero Opaco Goffrato / Embossed Matt Black	Nero Soft Touch / Soft Touch Black				

SHOWER

ZD1050

Disegno Complessivo / Overall Drawing

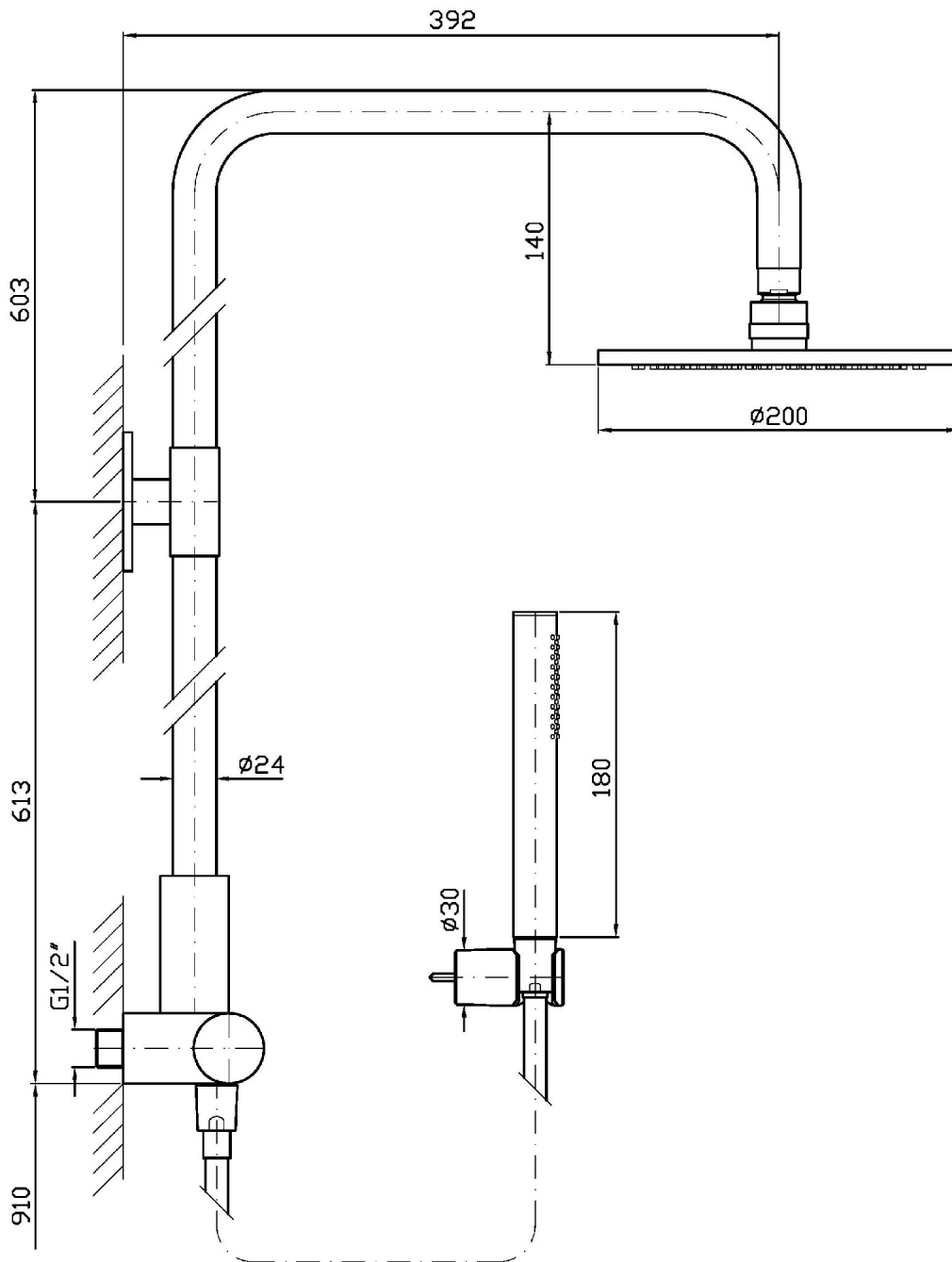

SHOWER

ZD1050

Esplosi / Exploded

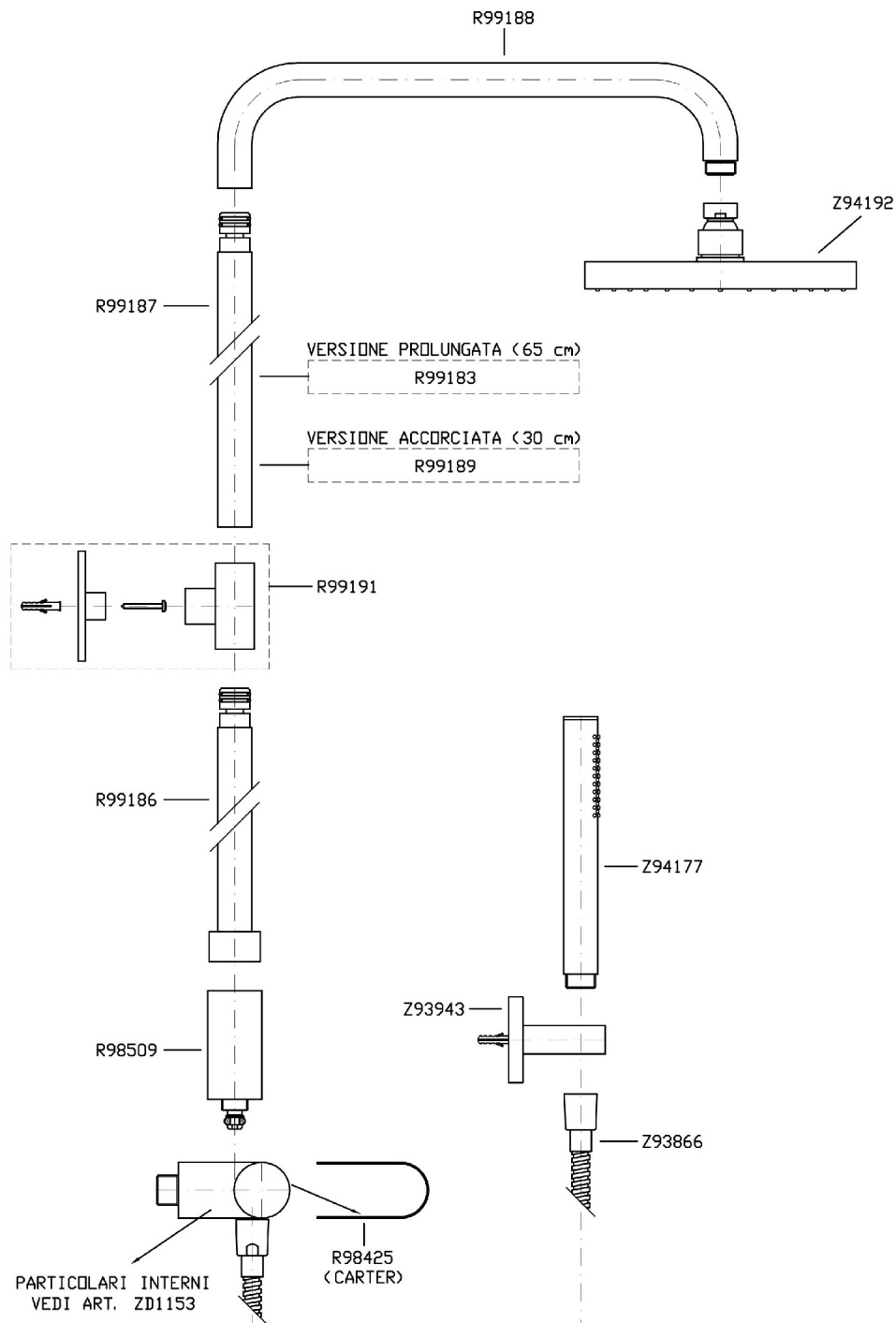

SHOWER

ZD1050 Portate / Flowrates (lt/min)

PRESSIONE PRESSURE	1 BAR	2 BAR	3 BAR	4 BAR	5 BAR
<i>P1</i> SOFFIONE SHOWER HEAD	11	13	16	18,5	21
<i>P2</i> DOCCETTA HANDSHOWER	6,7	10,1	11,9	13,5	14,9
<i>P3</i>					
<i>P4</i>					
<i>P5</i>					

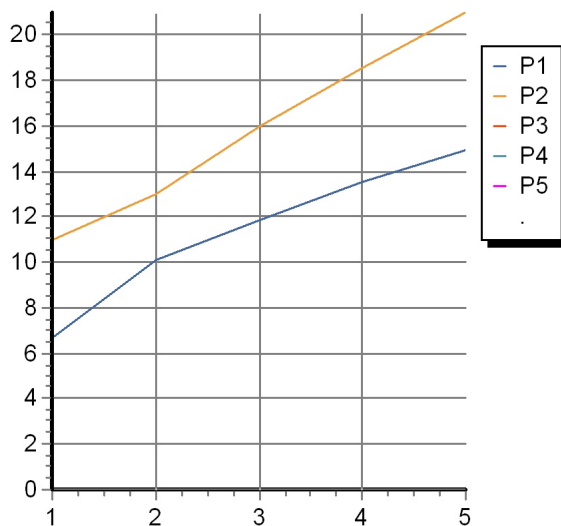

SHOWER

ZD1050 Pesì e Misure / Weights and Sizes

Peso (Kg) Weight (lb)	8,40 (Kg)	18,52 (lb)
Volume test (dc3) - (in3)	53,39 (dc3)	3258,06 (in3)
h (mm) - (in)	215,00 (mm)	8,46 (in)
L1 (mm) - (in)	260,00 (mm)	10,24 (in)
L2 (mm) - (in)	955,00 (mm)	37,60 (in)

