

# Lexium Controller

User's manual

## Ethernet Modbus TCP/IP

Retain for future use

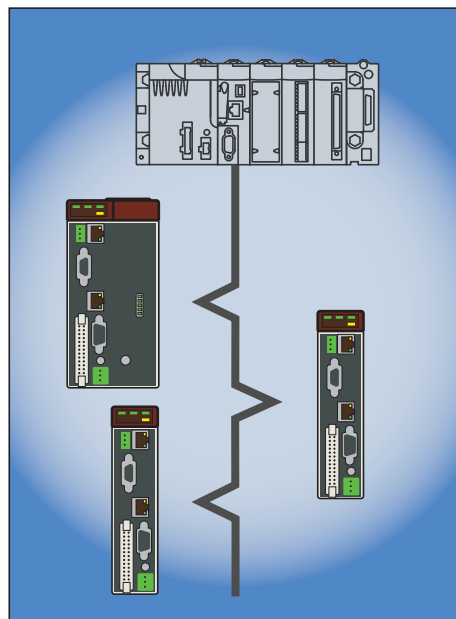



# Contents

---

Important information	5
Documentation structure	6
Introduction	7
Presentation	7
Notation	7
Hardware description	7
Connecting to the Ethernet network	8
Lexium Controller RJ45 connector pinout	8
Example of connection to an Ethernet network	8
Ethernet network connection elements	9
Access to Ethernet menu via the graphic display terminal	10
Ethernet menu parameters	10
Configuration	11
List of functions to be configured	11
IP addresses	12
IO Scanning	14
Communication faults	14
Diagnostics	15
LEDs	15
Available information	15
Communication fault	15
Software Setup	16
List of services supported	16
TCP connections	16
Modbus TCP server	17
Modbus TCP frames	17
Lexium Controller Modbus servers	17
Ethernet interface parameters	18
List of Modbus functions supported	21
"Read Holding Registers" function (3)	21
"Write Single Register" function (6)	22
"Write Multiple Registers" function (16 = 16#10)	23
"Read/Write Multiple Registers" function (23 = 16#17)	24
"Read Device Identification" function (43 = 16#2B)	25
IO Scanning service	26
Presentation	26
Ethernet with Motion Pro/CoDeSys	26
Periodic variables	27
Standard Web server	28
Web server functions	28
Applets	29
Access to the Web server	30
Web server user interface	31
"Home" menu	31
"Monitoring" menu	32
"LMC Viewer" page	33
"Data Viewer" page	34
"LMC Chart" page	35
"Diagnostics" menu	35
"Ethernet Statistics" page	36
"Setup" menu	36
"HTTP password" and "Data write password" pages	37
"Ethernet Configuration" page	38
FTP Server	40
Web server downloads	42
Setup using PL7	44
Setup using Concept	50
Setup using ProWORX NxT	51

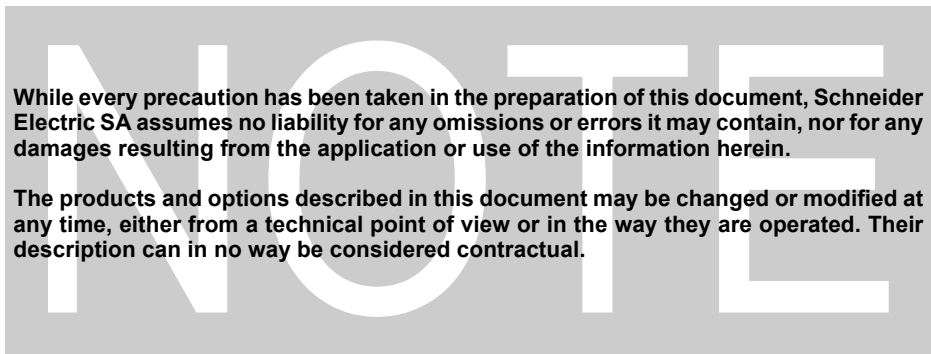

# Important information

---

## PLEASE NOTE

Please read these instructions carefully and examine the equipment in order to familiarize yourself with the device before installing, operating or carrying out any maintenance work on it.

The following special messages that you will come across in this document or on the device are designed to warn you about potential risks or draw your attention to information that will clarify or simplify a procedure.



The addition of this symbol to a "Danger" or "Warning" safety label indicates the presence of an electrical hazard that will result in injury if the instructions are not followed.



This is a safety warning symbol. It warns you of the potential risk of injury. You must comply with all safety messages that follow this symbol in order to avoid the risk of injury or death.

## **DANGER**

DANGER indicates an imminently hazardous situation which, if not avoided, **will result in** death, serious injury or equipment damage.

## **WARNING**

WARNING indicates a potentially hazardous situation which, if not avoided, **can result in** death, serious injury or equipment damage.

## **CAUTION**

CAUTION indicates a potentially hazardous situation which, if not avoided, **can result in** injury or equipment damage.

## PLEASE NOTE:

Only qualified staff are authorized to carry out maintenance work on electrical equipment. Schneider Electric accepts no responsibility for the consequences of using this device. This document does not constitute an instruction manual for inexperienced people.  
© 2008 Schneider Electric. All rights reserved.

# Documentation structure

---

## Installation Manual

This manual describes:

- How to install the controller
- How to connect the controller

## Optional Graphic Display Terminal User's Manual

This manual describes:

- How to install the graphic display terminal
- How to connect the graphic display terminal
- How to program the controller via the graphic display terminal

## Easy Motion - Programming Manual

Supplied preinstalled in the Lexium Controller, the application model associated with Easy Motion mode is a user-friendly tool that can be used for:

- Rapid axis configuration
- Use of Manual/Automatic mode
- Creating positioning tasks
- Editing cam profiles
- Backup and recovery of machine parameters
- Diagnostics of the motion controller and the various axes

This programming manual also contains a table of the parameters that can be accessed via the communication protocols.

## Motion Pro - Programming Manual

The Motion Pro Programming Manual is included in the software online help.

This online help describes:

- The software interface
- IEC 1131 programming
- The function libraries (standard functions, motion control functions, application functions)
- The Lexium controller configuration screens

## Modbus, Ethernet, PROFIBUS DP, and DeviceNet manuals

These manuals describe:

- Connection to the bus or network
- Diagnostics
- Software setup
- The protocol communication services

# Introduction

---

## Presentation

The Ethernet connection is used to connect a Lexium Controller to an Ethernet network using the Modbus TCP/IP protocol and Transparent Ready services.

The connection is made using a shielded RJ45 Ethernet connector.

The accessories for connection to the Ethernet network must be ordered separately.

This link is used to make all the data of the application managed by the Lexium Controller available to other equipment. It is also used to receive data from this equipment in order to coordinate their tasks.

The standard Web server (English only) provides access to the following pages:

- LMC Viewer
- Data Viewer
- Ethernet
- Security

Etc.

The standard Web server can be adapted or replaced by a customized server according to the requirements of the application.

## Notation

### Displays on the graphic display terminal

The graphic display terminal menus are shown in square brackets.

Example: [LC CONFIGURATION]

### Formats

Hexadecimal values are written as follows: 16#

Binary values are written as follows: 2#

## Hardware description

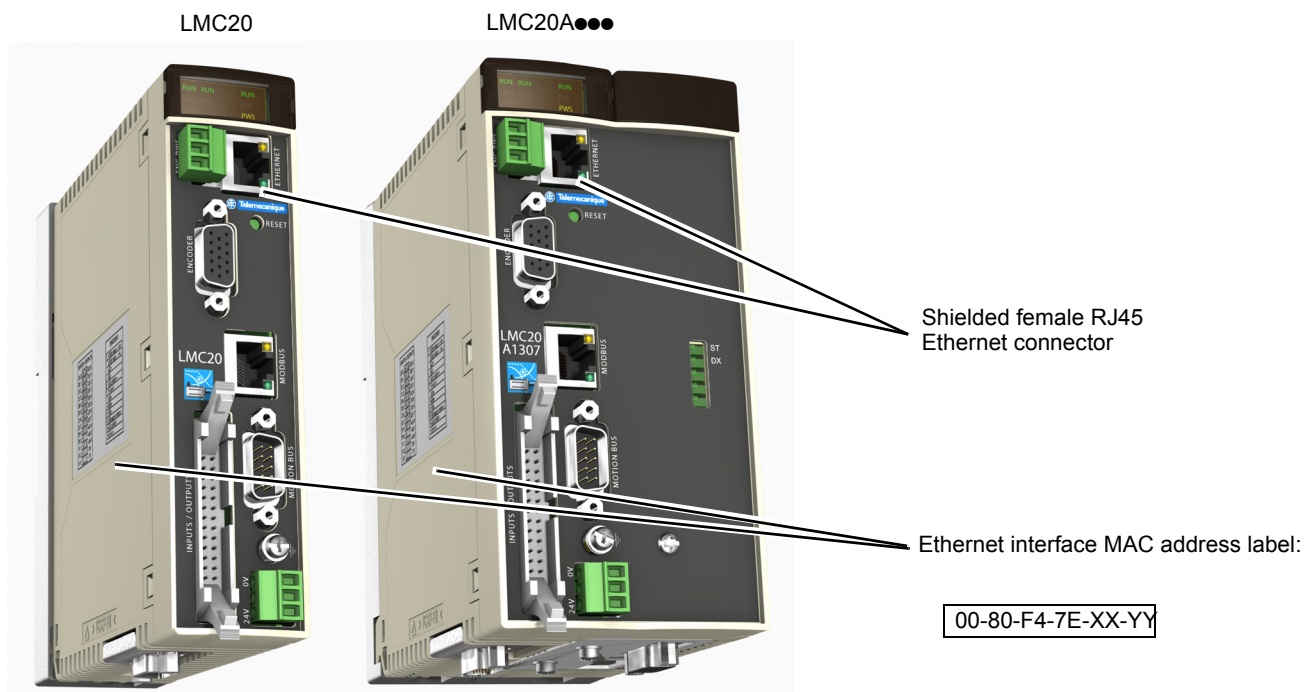

# Connecting to the Ethernet network

## Lexium Controller RJ45 connector pinout

The Ethernet connection is equipped with a shielded RJ45 connector. The shielding is connected to the Lexium Controller ground. Use an STP (shielded twisted pair) Ethernet cable.

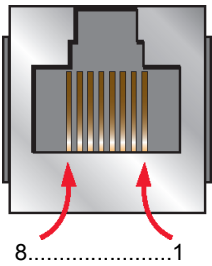

Pin	Signal
1	TD+
2	TD-
3	RD+
4	
5	
6	RD-
7	
8	

The transmission speed is detected automatically by the Lexium Controller (10 Mbps or 100 Mbps).

The Lexium Controller can operate in half duplex or full duplex mode, whether connected to a hub or a switch and regardless of the transmission speed (10 Mbps or 100 Mbps).

The Lexium Controller supports the ETHERNET 2 frame format (IEEE 802-3 not supported).

## Example of connection to an Ethernet network

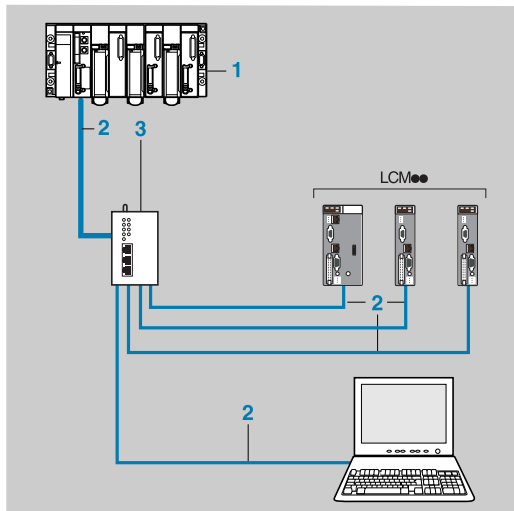

- 1 TSX PREMIUM PLC with TSX ETY 4101 or 5101 module
- 2 490 NTW 000 02 cable
- 3 499 NEH 104 10 hub



# Connecting to the Ethernet network

## Ethernet network connection elements

Please refer to the "Ethernet TCP/IP and the Web" catalog (see website [www.telemecanique.com](http://www.telemecanique.com)).

### Connection cables

Item	Use		Length m	Reference
	From	To		
<b>Straight shielded twisted pair cables</b> 2 RJ45 connectors	Lexium Controller	Hubs	2	<b>490 NTW 000 02</b>
		499 N●H 1●● 10, Switches	5	<b>490 NTW 000 05</b>
		499 N●S 171 00	12	<b>490 NTW 000 12</b>
			40	<b>490 NTW 000 40</b>
			80	<b>490 NTW 000 80</b>

### Hubs and switches

Item	Description	Reference
<b>Hubs</b>	4 x 10BASE-T ports	<b>499 NEH 104 10</b>
	4 x 100BASE-TX ports	<b>499 NEH 141 10</b>
	3 x 10BASE-T ports 2 x 10BASE-FL ports, multimode optical fiber, ST connectors (BFOC)	<b>499 NOH 105 10</b>
<b>Switches</b>	5 x 10BASE-T/100BASE-TX ports Optimized, cannot be configured	<b>499 NES 251 00</b>
	4 x 10BASE-T/100BASE-TX ports 1 x 100BASE-FX port, multimode optical fiber, SC connectors Cannot be configured	<b>499 NMS 251 01</b>
	3 x 10BASE-T/100BASE-TX ports 2 x 100BASE-FX ports, multimode optical fiber, SC connectors Cannot be configured	<b>499 NMS 251 02</b>
	4 x 10BASE-T/100BASE-TX ports 1 x 100BASE-FX port, single-mode optical fiber, SC connectors Cannot be configured	<b>499 NSS 251 01</b>
	3 x 10BASE-T/100BASE-TX ports 2 x 100BASE-FX ports, single-mode optical fiber, SC connectors Cannot be configured	<b>499 NSS 251 02</b>
	8 x 10BASE-T/100BASE-TX ports Cannot be configured	<b>499 NES 181 00</b>
	7 x 10BASE-T/100BASE-TX ports Configurable	<b>499 NES 271 00</b>
	5 x 10BASE-T/100BASE-TX ports 2 x 100BASE-FX ports, multimode optical fiber, SC connectors Configurable	<b>499 NOS 271 00</b>
	5 x 10BASE-T/100BASE-TX ports 2 x 100BASE-FX ports, single-mode optical fiber, SC connectors Configurable	<b>499 NSS 271 00</b>

# Ethernet menu

## Access to Ethernet menu via the graphic display terminal

The [\[LC CONFIGURATION\]](#) submenu is used to configure and display the Ethernet interface parameters.

## Ethernet menu parameters

Description	
<b>■ [IP Address]</b>	
<b>M [139.160.069.241]</b> IP address of the Ethernet interface	
Type:	Configuration (read and write) Display (read-only) if the address has been supplied by a BOOTP or DHCP server
Possible values:	<ul style="list-style-type: none"><li>• 0 to 255 for each of fields IPC1, IPC2, IPC3 and IPC4</li><li>• If the value is <a href="#">[0.0.0.0]</a>, the Ethernet interface waits for an address from a BOOTP or DHCP server.</li></ul> <b>Note:</b> If you enter a value other than <a href="#">[0.0.0.0]</a> , dynamic addressing by a BOOTP or DHCP server is disabled. <b>Note:</b> After dynamic addressing by a BOOTP or DHCP server, the value <a href="#">[0.0.0.0]</a> is replaced by the address supplied.
Default value:	<a href="#">[0.0.0.0]</a> until LMC firmware V01.02IE02 (included) <a href="#">[192.168.100.0]</a> for higher versions
<b>■ [IP Mask]</b>	
<b>M [255.255.254.0]</b> Subnet mask	
Type:	Configuration (read and write) Display (read-only) if the address has been supplied by a BOOTP or DHCP server
Possible values:	<ul style="list-style-type: none"><li>• 0 to 255 for each of fields IPM1, IPM2, IPM3 and IPM4</li><li>• If the value of the IP address <a href="#">[IP Address]</a> is <a href="#">[0.0.0.0]</a>, the Ethernet interface waits for a mask from a BOOTP or DHCP server.</li></ul> <b>Note:</b> After dynamic addressing by a BOOTP or DHCP server, the current value is replaced by the address supplied.
Default value:	<a href="#">[0.0.0.0]</a> until LMC firmware V01.02IE02 (included) <a href="#">[255.255.255.0]</a> for higher versions

# Configuration

---

## List of functions to be configured

The table below gives the list of configuration functions and how they can be accessed:

Function		Graphic display terminal	Motion Pro/ CoDeSys	Standard Web server
Entering the IP addresses		●	●	
DHCP	Entering the device name		●	
IO Scanning	Enable IO Scanner			●
Reserving control (IP master)				●
Communication monitoring (see <a href="#">"LEDs", page 15</a> )				●
Security of access to the standard Web server	Changing the "username"			
	Changing the "HTTP password"			●
	Changing the "Write password"			●

Configuration using the graphic display terminal of the Lexium Controller is explained in the "Configuration" section.

Configuration using the standard Web server is explained in the "Standard Web server" section.

**Note:** The Ethernet interface saves its configuration (IP address, mask, gateway, etc.) to the EEPROM each time the configuration is modified.

# Configuration

## IP addresses

### ■ Assigning IP addresses

The Lexium Controller needs 3 IP addresses:

- The Lexium Controller IP address
- The subnet mask
- The gateway IP address

These IP addresses can be entered directly, using:

- The graphic display terminal
- Easy Motion software
- Motion Pro/CoDeSys

They can be provided by:

- A BOOTP server (correspondence between the MAC address and the IP addresses)
- Or a DHCP server (correspondence between Device Name and the IP addresses)

If an IP address other than @ IP : 0.0.0.0. has been entered using the display terminal or Motion Pro/CoDeSys, assignment using a server is disabled.

The BOOTP service is enabled:

- When IP : 0.0.0.0.
- And when no device name has been entered.

The DHCP service is enabled:

- When IP : 0.0.0.0.
- And when the device name has been entered.

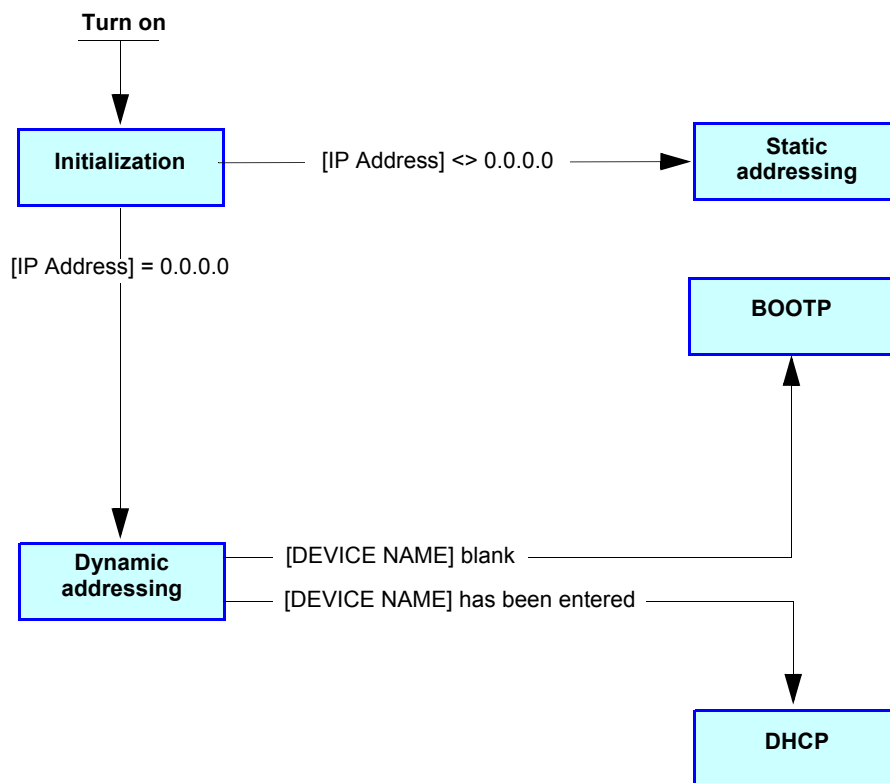

### ■ Entering the IP addresses in the terminal

In the [\[LC CONFIGURATION\]](#) menu, enter the IP addresses:

- [\[IP Address\]](#)

#### Important:

Turn the Lexium Controller off and then on again or press the reset button on the front panel, otherwise the IP addresses will not be taken into account.

**Note:** Before entry begins, the IP address displayed is the active IP address.

If this address is modified, the new IP address entered is displayed. This IP address will be effective the next time the Lexium Controller is reset.

# Configuration

## ■ BOOTP

The BOOTP service is used to assign IP addresses from the MAC address. The MAC address consisting of 6 hexadecimal digits (00-80-F4-7F-xx-yy) must be entered in the BOOTP server. The MAC address appears on the label attached to the Lexium Controller.

In the [\[LC CONFIGURATION\]](#) menu:

- Configure the IP address [\[IP Address\]](#) at value [\[0.0.0.0\]](#).

## ■ Entering the IP addresses using Motion Pro/CoDeSys

(1)

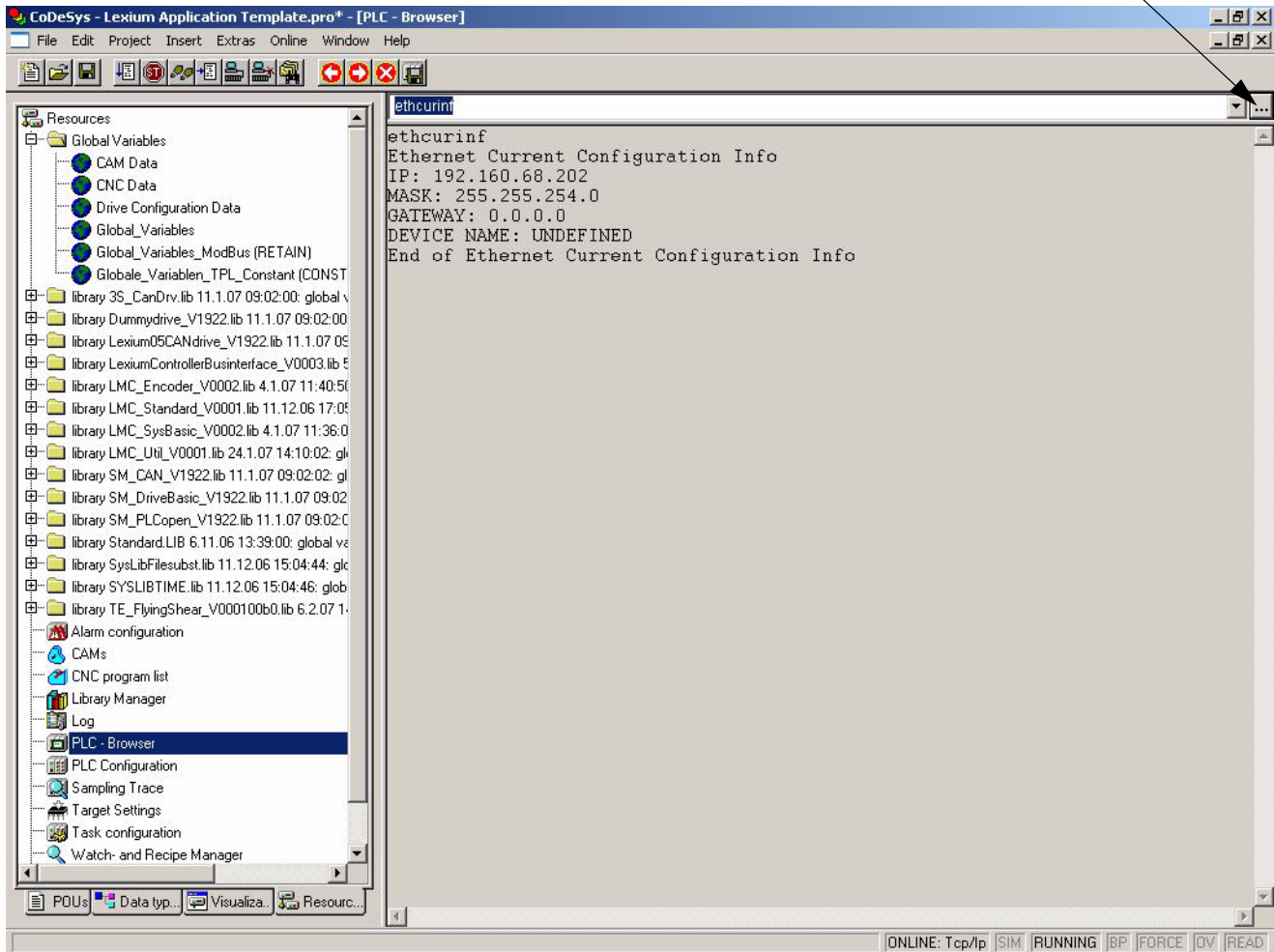

Go to the Motion Pro/CoDeSys program

└─▶ Tab: Resources

└─▶ Tab: PLC Browser

(1) Pressing this button allows the display of the orders available with the PLC Browser.

The following commands can be used with the PLC Browser:

- |                                |   |
|--------------------------------|---|
| <b>ip &lt;x.x.x.x&gt;</b>      | To enter the IP address (0 to 255)  |
| <b>mask &lt;x.x.x.x&gt;</b>    | To enter the MASK address (0 to 255)  |
| <b>gateway &lt;x.x.x.x&gt;</b> | To enter the Gateway address (0 to 255)   |
| <b>ethinf</b>                  | To display Ethernet-related information that will be applied the next time the Lexium Controller is turned on |
| <b>ethcurinf</b>               | To display the Ethernet-related information that is currently being used                                      |
| <b>dname &lt;name&gt;</b>      | To enter the Device Name  |

# Configuration

---

## IO Scanning

Refer to the section entitled [“IO Scanning service”, page 26](#).

The Lexium Controller IO Scanning service can be enabled or disabled via the Web server.

## Communication faults

### ■ Communication monitoring

The Ethernet interface can detect two types of fault:

- Network management faults (server missing, duplication of IP address, etc.)
- Communication faults (time out on the master traffic, etc.)

### ■ Network management fault

The IP address duplication management fault cannot be configured. It is given in parameter 60288.

If the BOOTP or DHCP service is configured, current search information for the server is available in parameter 60288.

### ■ Communication fault

It is strongly recommended that management of the IO scanner function is performed by one master device only. Monitoring starts when the first IP Master frame is received.

- If IP Master has been configured:  
A communication fault is triggered if the Ethernet module does not receive a Modbus TCP request within a predefined period of time (time out).  
Any type of Modbus request from the master device [[IP Master](#)] is taken into account (write operation, read operation, etc.).
- If IP Master is not reserved:  
No time out management.

The time out is adjustable from 0.5 s to 60 s, via the Web server.

Information on the type of fault that has caused this malfunction is given in parameter 60049.

The value of the time out can be configured via parameter 60045.

# Diagnostics

## LEDs

The Ethernet connector has two LEDs.

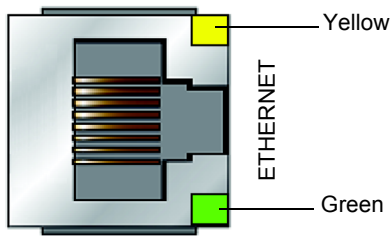

The following table gives the meanings of the various states of these LEDs.

Color	Status	Meaning		
Yellow	On	Transmission/Reception of a frame by the Ethernet interface		
Green	Off	No IP address entered, or assigned by a BOOTP or FDR (DHCP) server		
	On	IP address correctly configured and Lexium Controller connected		
	Flashing	3 flashes:	The Lexium Controller is not connected	<b>Corrective action:</b> Check the network wiring
		4 flashes:	Another device has the same IP address as the Lexium Controller	<b>Corrective action:</b> Disconnect one of the devices involved or modify its IP address, then restart the Lexium Controller
5 flashes:		Dynamic addressing is in progress (not yet completed)	<b>Corrective action:</b> If this state lasts too long, check the IP address server	

## Available information

In addition to the LEDs, the table below summarizes the diagnostic information available by various means.

Function	Standard Web server
Communication diagnostics <ul style="list-style-type: none"><li>• Transmission counter</li><li>• Reception counter</li><li>• Collision counter</li><li>• Etc.</li></ul>	●

## Communication fault

### ■ Communication monitoring

- No communication of IO Scanning frames can be detected by the Ethernet interface.
- The IO Scanner function must be enabled (YES).
- At least one IO Scanner frame must be received to activate the detection of loss of communication function (Time out).
- If an IP MASTER address has been configured, only this IP address can write the IO Scanner.
- If IP MASTER is set to NOT DEFINED, all the equipment on the network can write the IO Scanner. In this case there is no management of the Time out.

# Software Setup

---

## List of services supported

- Modbus TCP server, with the support of the "IO Scanning" periodic service
- IP protocol (version 4)
- TCP and UDP protocol
- HTTP server for configuring, adjusting and monitoring the Lexium controller
- ICMP client for supporting certain IP services, such as the "ping" command
- BOOTP client for assignment of an IP address by an address server
- FTP protocol for file transfer
- DHCP client for dynamic assignment of IP addresses by an address server
- ARP protocol for detecting a competing IP address (IP address already in use)

## TCP connections

Number of simultaneous connections limited to 8 maximum (port 502).

The table below gives the number of connections consumed for each service:

Client	Service	Number of connections
Controller (PLC)	IO Scanning	1
	Modbus Messaging	1
Web browser	"Home" page	0
	"Monitoring\LMC Viewer" page	1
	"Monitoring\Data Viewer" page	1
	"Monitoring\LMC chart" page	1
	"Diagnostics\Ethernet Statistics" page	1
	"Setup\Security\HTTP password" page	0
	"Setup\Security\Data write password" page	0
	"Setup\Ethernet Configuration" page	1

Example:

If the "LMC Viewer" page is viewed in two different windows of a Web browser, on the same PC, two connections are consumed.

If the Lexium Controller is controlled by a PLC, two connections are consumed by IO Scanning and Modbus messaging, so the total number of connections consumed is then four.

Four connections are still available, since the maximum number of simultaneous connections is eight.

If a Master address is configured, two connections are reserved for this device, even if it is not present on the network.

If the maximum number of connections has been exceeded, any new connection attempt will be rejected by the Ethernet interface.



# Modbus TCP server

---

## Modbus TCP frames

Modbus TCP frames consist of a header and a Modbus request.

### Header format:

Byte	Description		Comments
0	Transaction identifier	high order	
1		low order	
2	Protocol identifier	high order	This identifier always equals 0.
3		low order	
4	Length of data	high order	Number of bytes in the Modbus request +1. The frame length is always less than 256 bytes, the value of the high order byte therefore equals 0.
5		low order	
6	Destination identifier (Unit ID)		
7	Modbus request function code		

The frame header returned by the Lexium Controller server is identical to that of the frame sent by the client.

## Lexium Controller Modbus servers

The destination identifier (Unit ID) is used to access three Lexium Controller Modbus TCP servers:

Unit ID	Modbus TCP server	Accessible parameters
0 or Modbus address	Lexium Controller	% MW
251	Ethernet Interface	See the section entitled <a href="#">"Ethernet interface parameters", page 18.</a>
255	IO Scanner	See the section entitled <a href="#">"IO Scanning service", page 26.</a>

# Modbus TCP server

## Ethernet interface parameters

### Comments:

- Parameters on 2 words are double words (low order in address word n, high order in address word n+1).
- Parameters 60 019 to 60 043 and 60 066 to 60 068 can be accessed in both read and write mode. They can be reset using a write operation.
- The current IP addresses (60006 to 60017) are those displayed on the terminal or via the IP function in the Motion Pro/CoDeSys Browser. The EEPROM IP addresses (60075 to 60079) are those currently used by the Ethernet interface.

Address	Size (in words)	Description	Access	Possible values, comments
60 000	6	MAC address	R	00-80-F4-7E-xx-yy 00: 60 000 80: 60 001 F4: 60 002 7E: 60 003 xx: 60 004 yy: 60 005
60 006	4	Current value of IP address [IP Address]	R/W	IPC1: 60 006 IPC2: 60 007 IPC3: 60 008 IPC4: 60 009
60 010	4	Current value of Subnet mask	R/W	IPM1: 60 010 IPM2: 60 011 IPM3: 60 012 IPM4: 60 013
60 014	4	Current value of Gateway Address	R/W	IPG1: 60 014 IPG2: 60 015 IPG3: 60 016 IPG4: 60 017
60 018	1	Transmission speed	R	= 0 : Speed not defined = 10 : 10 Mbps = 100 : 100 Mbps
60 019	2	OK transmission counter	R/W	
60 021	1	Store-and-forward transmission counter	R/W	
60 022	1	Late collision counter	R/W	
60 023	1	Buffer (Tx) error counter	R/W	
60 024	2	OK reception counter	R/W	
60 026	1	CRC error counter	R/W	
60 027	1	Frame error counter	R/W	
60 028	1	Buffer (Rx) error counter	R/W	
60 029	1	Collision counter	R/W	
60 030	1	Multiple collision counter	R/W	
60 031	1	OverRun counter	R/W	
60 032	2	Sent Modbus TCP message counter	R/W	IO Scanning messages not included
60 034	2	Received Modbus TCP message counter	R/W	IO Scanning messages not included
60 036	1	Modbus TCP message error counter	R/W	IO Scanning messages not included
60 037	2	Sent IO Scanning message counter	R/W	
60 039	2	Received IO Scanning message counter	R/W	
60 041	1	IO Scanning message error counter	R/W	
60 042	1	Active traffic (msg/s)	R/W	
60 043	1	Max. traffic (msg/s)	R/W	
60 044	1	Number of active TCP connections	R	8 maximum

# Modbus TCP server

---

Address	Size (in words)	Description	Access	Possible values, comments
60 045	1	Communication monitoring time out	R/W	Unit: 0.1s; min. = 5 (0.5 s); max. = 600 (60.0 s)
60 046	1	Type of device	R	= 3 Lexium Controller
60 047	1	Reserved	R	= 0
60 048	1	Enable IO Scanner	R/W	= 0 [No] : IO Scanning disabled = 1 [Yes] : IO Scanning enabled
60 049	1	IO Scanner status = 0 → No Time Out = 1 → Time Out due to a network overload = 2 → Time Out due to disconnected cable = 3 → Other Time Out	R	
60 050	4	IP Master address [IP Master]	R/W	IPP1 = 60 050 IPP2 = 60 051 IPP3 = 60 052 IPP4 = 60 053
60 054	4	DHCP-BOOTP server IP address	R	IPF1 = 60 054 IPF2 = 60 055 IPF3 = 60 056 IPF4 = 60 057

# Modbus TCP server

Address	Size (in words)	Description	Access	Possible values, comments
60 070	5	Reserved	R	
60 075	4	IP address (EEPROM value)	R	IPC1 = 60 075 IPC2 = 60 076 IPC3 = 60 077 IPC4 = 60 078
60 079	4	Subnet mask (EEPROM value)	R	IPM1 = 60 079 IPM2 = 60 080 IPM3 = 60 081 IPM4 = 60 082
60 083	4	Gateway (EEPROM value)	R	IPG1 = 60 083 IPG2 = 60 084 IPG3 = 60 085 IPG4 = 60 086
60 087	20	Reserved	R	
60 107	1	Method of assigning IP addresses	R	0 = Configuration via the display terminal or Browser 1 = Configuration via BOOTP 2 = Configuration via DHCP
60 108		Reserved		
60 112 to 60 117				
60 202				
60 287	1			
60 288	1	Ethernet status: 0: Int 1: Communication OK 3: Cable disconnected 4: Duplicate IP Address 5: BOOTP/DHCP sequence in progress		
60 289	1	CanOpen status: 9: RUN 98 - 99: ERROR Other: STOPPED		
60 290	1	CanMotion (SYNC) status: 0: STOPPED 1: RUN		
60 291	1	Lexium Controller name: 'D' (0x44): LMC20A1309 (DeviceNet) 'P' (0x50): LMC20A1307 (Profibus) 0: None		
60 292	1	Lexium Controller status: Value depends on the Lexium Controller model		See the DeviceNet Manual or the Profibus Manual
60 293	1	RTS status: 0: RUN 1 - 2: STOP		
60 294	1	Reserved		
60 295	1	Product Code: 0: LMC10 1: LMC20 2: LMC20A1307 3: LMC20A1309		
60 296	1	Configurable Modbus Address		Only used for the Modbus serial link (RS485)

# Modbus TCP server

## List of Modbus functions supported

Code (decimal)	Modbus name	Description	Size of data
3 = 16#03	Read Holding Registers	Read N output words	121 words max.
6 = 16#06	Write Single Register	Write one output word	–
16 = 16#10	Write Multiple Registers	Write N output words	121 words max.
23 = 16#17	Read/Write Multiple Registers	Read/write N words	11 / 11 words max.
43 = 16#2B	Read Device Identification	Identification	–

### "Read Holding Registers" function (3)

This Modbus request is used to read the values of a number (No. of Points) of adjacent words starting at the address indicated (Starting Address). The values read are restored one after another, at the end of the response (First Point Data → Last Point Data).

Request format:

Byte	Meaning
0	Function Code = <b>16#03</b>
1	Starting Address Hi
2	Starting Address Lo
3	No. of Register Hi (0)
4	No. of Register Lo (1-121)

Response format:

Byte	Meaning
0	Function Code = <b>16#03</b>
1	Byte Count (B = 2 × No. of Points)
2	First Register Data Hi
3	First Register Data Lo
...	.....
B	Last Register Data Hi
B+1	Last Register Data Lo

Exception response format:

Byte	Meaning	For Ethernet Interface
0	Function Code = <b>16#83</b>	
1	Exception Code	01 (Illegal Function) 02 (Illegal Data Address)

# Modbus TCP server

---

## "Write Single Register" function (6)

This Modbus request is used to write a given value (Preset Data) to the address supplied (Register Address).

Request format:

Byte	Meaning
0	Function Code = <b>16#06</b>
1	Register Address Hi
2	Register Address Lo
3	Preset Data Hi
4	Preset Data Lo

Response format:

Byte	Meaning
0	Function Code = <b>16#06</b>
1	Register Address Hi
2	Register Address Lo
3	Preset Data Hi
4	Preset Data Lo

Exception response format:

Byte	Meaning	For Ethernet Interface
0	Function Code = <b>16#86</b>	
1	Exception Code	01 (Illegal Function) 02 (Illegal Data Address)

# Modbus TCP server

---

## "Write Multiple Registers" function (16 = 16#10)

This Modbus request is used to write a number (No. of Registers) of adjacent words starting at a given address (Starting Address). The values to be written are supplied one after another (First Register Data → Last Register Data).

Request format:

Byte	Meaning
0	Function Code = <b>16#10</b>
1	Starting Address Hi
2	Starting Address Lo
3	No. of Registers Hi (0)
4	No. of Registers Lo (1-121)
5	Byte Count (B = 2 × No. of Registers)
6	First Register Data (Hi)
7	First Register Data (Lo)
...	.....
B+4	Last Register Data (Hi)
B+5	Last Register Data (Lo)

Response format:

Byte	Meaning
0	Function Code = <b>16#10</b>
1	Starting Address Hi
2	Starting Address Lo
3	No. of Registers Hi (0)
4	No. of Registers Lo (1-121)

Exception response format:

Byte	Meaning	For Ethernet Interface
0	Function Code = <b>16#90</b>	
1	Exception Code	01 (Illegal Function) 02 (Illegal Data Address)

# Modbus TCP server

## "Read/Write Multiple Registers" function (23 = 16#17)

The "Read/Write Multiple Registers" service is reserved for setting up the IO Scanning service (see section ["IO Scanning service", page 26](#)).

Request format:

Byte	Meaning	For Ethernet Interface
0	Function Code = <b>16#17</b>	<b>16#17</b>
1	Read Reference Address Hi	0 (not handled)
2	Read Reference Address Lo	0 (not handled)
3	Quantity to Read Hi (0)	0
4	Quantity to Read Lo (1-125)	11
5	Write Reference Address Hi	0 (not handled)
6	Write Reference Address Lo	0 (not handled)
7	Quantity to Write Hi (0)	0
8	Quantity to Write Lo (1-100)	11
9	Byte Count (2 × Quantity to Write)	22
10	Write Data 01 (Hi)	Value of 1st IO Scanner output register
11	Write Data 01 (Lo)	
...	.....	.....
30	Write Data 11 (Hi)	Value of 11th register
31	Write Data 11 (Lo)	

Response format:

Byte	Meaning	For Ethernet Interface
0	Function Code = <b>16#17</b>	<b>16#17</b>
1	Byte Count (2 × Quantity to Write)	22
2	Read Data 01 (Hi)	Value of 1st IO Scanner input register
3	Read Data 01 (Lo)	
...	.....	.....
22	Read Data 11 (Hi)	Value of 11th register
23	Read Data 11 (Lo)	

Exception response format:

Byte	Meaning	For Ethernet Interface
0	Function Code = <b>16#97</b>	<b>16#97</b>
1	Exception Code	01 (Illegal Function)



# Modbus TCP server

## "Read Device Identification" function (43 = 16#2B)

Request format:

Byte	Meaning	For Ethernet interface
0	Function Code = <b>16#2B</b>	16#2B
1	Type of MEI	16#0E
2	Read Device ID code	16#01: Basic 16#02: Regular 16#03: Extended
3	Object ID	16#00

Response format:

Byte(s)	Meaning	For Ethernet interface
0	Function code = <b>16#2B</b>	16#2B
1	Type of MEI	16#0E
2	ReadDeviceId code	16#01
3	Degree of conformity	16#02
4	Number of additional frames	16#00 (a single frame)
5	Next object ID	16#00
6	Number of objects	3 for Basic 4 for Regular or Extended
7	Object no. 1 ID	16#00 = Vendor Name
8	Length of object no. 1 (A)	13
9...21	Value of object no. 1 (A ASCII characters)	"Telemecanique"
22	Object no. 2 ID	16#01 = Product Code
23	Length of object no. 2 (B)	5 (for the following example only)
24...23+B	Value of object no. 2 (B ASCII characters) (1)	Example: "LMC20"
24+B	Object no. 3 ID	16#02 = Major.Minor Revision
25+B	Length of object no. 3 (C)	4
26+B...29+B	Value of object no. 3 (C ASCII characters)	Example: "0201" for version 2.1
30+B	Object no. 4 ID	16#06 = Application Name (2)
31+B	Length of object no. 4 (D)	8 (for the following example only)
32+B...31+B+D	Value of object no. 4 (D ASCII characters) (1)	Example: "MACHINE 4"

(1) The length of this field is variable. Use the "Length of object no. X" field associated with it to determine the length.

(2) In the case of the Lexium Controller, this data item corresponds to [\[DEVICE NAME\]](#).

The response to a "drive identification" request does not cause an exception response.

# IO Scanning service

## Presentation

The IO Scanning service is used to exchange periodic I/O data between:

- A controller or PLC (IO Scanner)
- Devices (IO Scanning servers)

This exchange is usually performed by implicit services, thus avoiding the need to program the controller (PLC). The IO Scanner periodically generates the Read/Write Multiple Registers (23 = 16#17) request.

The IO Scanning service operates if it has been enabled in the PLC and the Lexium Controller.

When the IO Scanning service has been enabled in the Lexium Controller:

- A TCP connection is assigned to it
- The parameters assigned in the periodic variables are exchanged cyclically between the Ethernet interface and the Lexium Controller program.
- The parameters assigned to the periodic output variables are reserved for IO Scanning. They cannot be written by other Modbus services, even if the IO Scanner is not sending its periodic output variables.

## Ethernet with Motion Pro/CoDeSys

The Ethernet information on data exchanged is available with Motion Pro/CoDeSys.

- 11 input words
- 11 output words

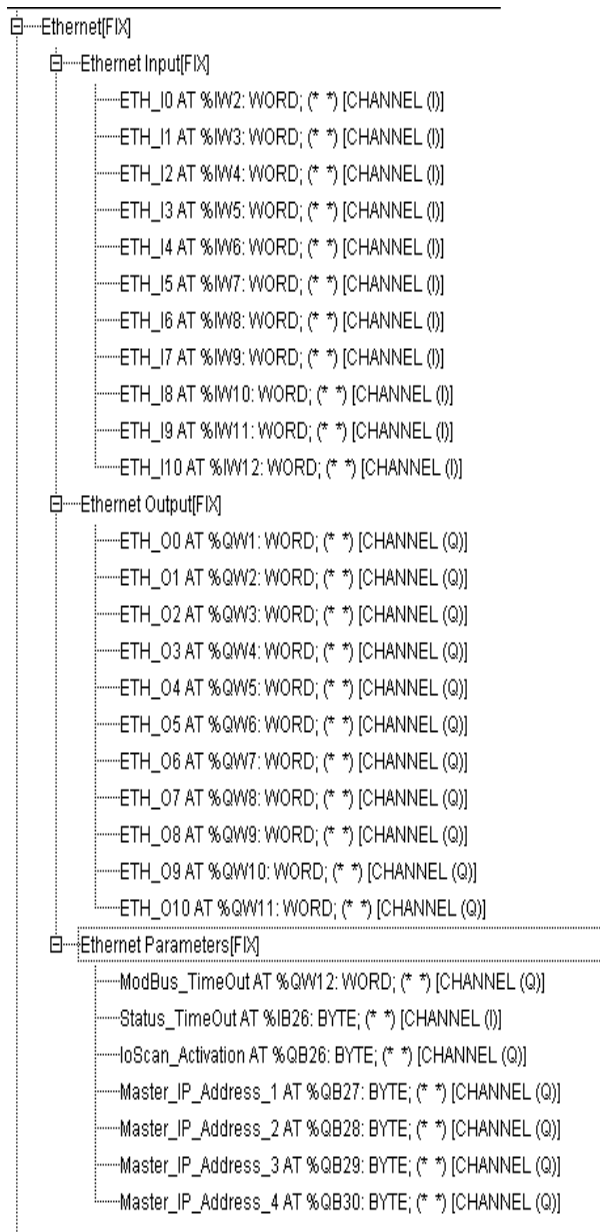

# IO Scanning service

---

## Periodic variables

The organization of the %IW and %QW depends on the configuration of the apparatus. The vision of the configuration below is given only as example.

Output variables (written by IO Scanner)		Input variables (read by IO Scanner)	
No.	Meaning/default assignment	No.	Meaning/default assignment
0	%IW2	0	%QW1
1	%IW3	1	%QW2
2	%IW4	2	%QW3
3	%IW5	3	%QW4
4	%IW6	4	%QW5
5	%IW7	5	%QW6
6	%IW8	6	%QW7
7	%IW9	7	%QW8
8	%IW10	8	%QW9
9	%IW11	9	%QW10
10	%IW12	10	%QW11

# Standard Web server

## Web server functions

Menu	Page	Function
HOME	English	Home page
MONITORING	LMC Viewer	Display of the main Lexium Controller parameters: state of the Lexium Controller logic I/O (Run/Stop) etc.
	Data Viewer	Display and password-protected modification of the Lexium Controller parameters, arranged in %MW order
	LMC Chart	Display of two selectable Lexium Controller %MW parameters in the form of an oscilloscope type time chart
DIAGNOSTICS	Ethernet Statistics	Display and resetting of the communication statistics
		Lexium Controller identification
SETUP	[Security] HTTP password	Changing the HTTP password used to access the Web server
	[Security] Data write password	Changing the Write password that allows modification of the parameters
	Ethernet Configuration	Enabling and disabling of IO Scanning (password-protected) Setting (password-protected) of the IO Scanning and Modbus TCP messaging time outs
DOCUMENTATION	References	Link to the web site <a href="http://www.telemecanique.com">http://www.telemecanique.com</a>

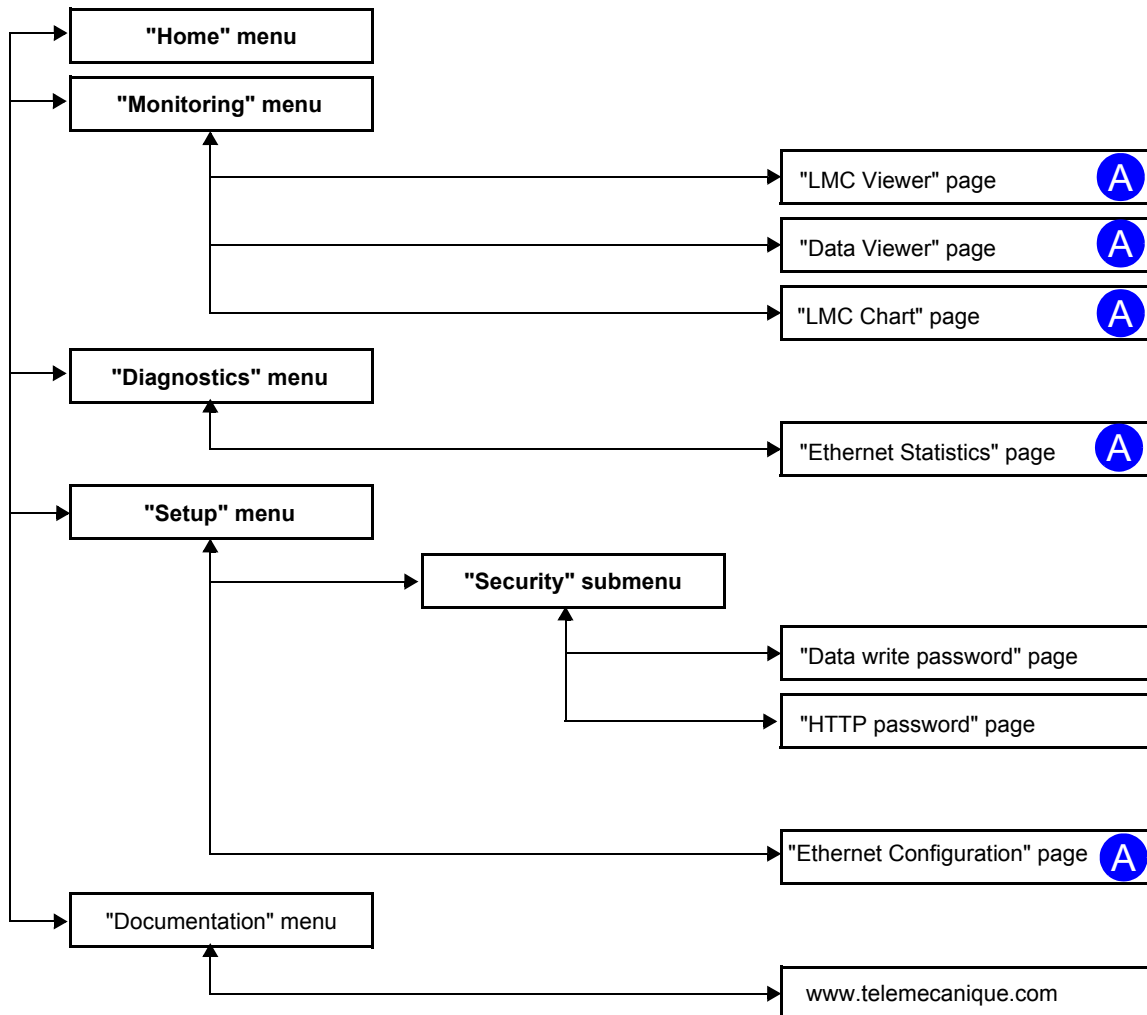

Pages which contain applets are marked "A".

# Standard Web server

---

## Applets

The Web server downloads Java programs called "applets" to your computer. These applets communicate with the Lexium Controller using Modbus services (on port 502), thus establishing one or more connections between the computer and the Lexium Controller. Until an applet has been fully transmitted from the Lexium Controller to the browser, a gray rectangle appears in the place reserved for it in the page.

The applet connects when the page is opened and remains connected until the page is closed.

**Display problems can occur with the SUN "Java virtual machine". Use the Internet Explorer default JVM.**

The applets associated with the Web pages monitor communication with the Lexium Controller. When the Lexium Controller no longer responds to requests to update the data, the message "Link down" is displayed in one field and all the other field contents are emptied.

Subsequently, the description of each page indicates the data refresh period requested by the applet loaded on the computer. The refresh period actually observed depends on:

- The performance of the computer on which the Web browser is running
- The communication system response time
- The amount of data to be refreshed on the page

# Standard Web server

---

## Access to the Web server

Number of Modbus TCP connections	0
----------------------------------	---

To connect to the Web server of a Lexium Controller located, for example, at IP address 139.160.69.241, enter the URL “<http://139.160.69.241/>” in the address bar of a Web browser.

When the browser first connects to the Lexium Controller Web server, the server requests entry of a username and a password (HTTP password).

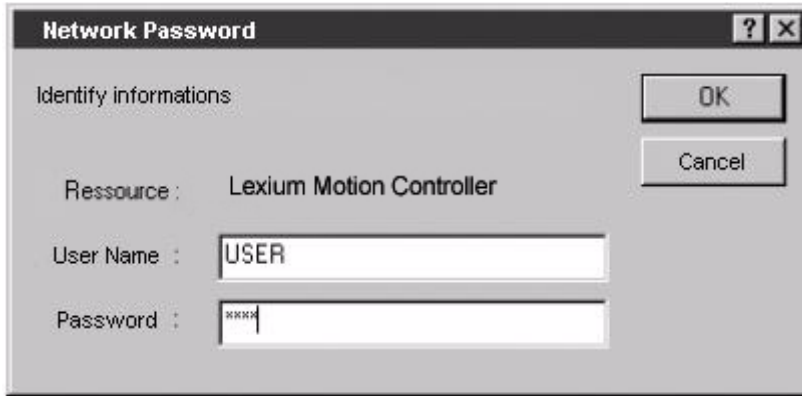

The default username and password (HTTP password) are both "USER" (upper case).

If authentication is accepted, the home page is displayed. If not, after three failed attempts, access to this page is denied:

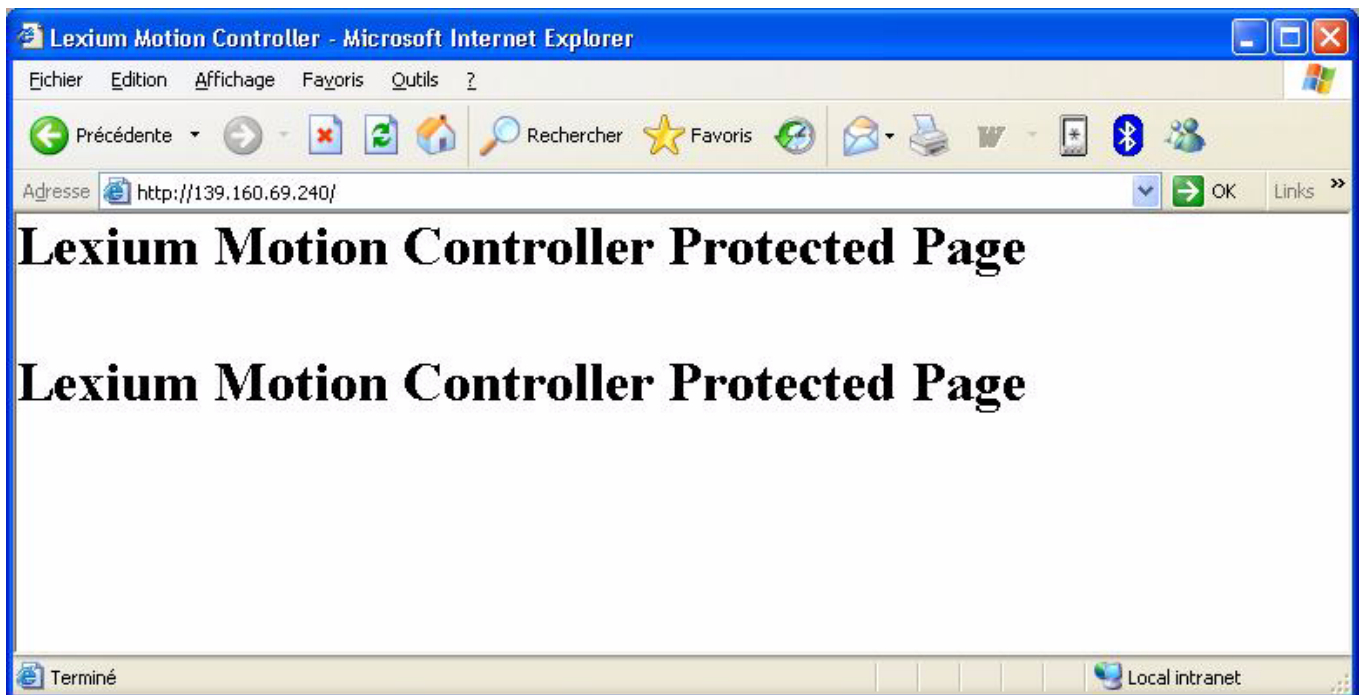

To attempt a new connection to the Lexium Controller server home page, simply refresh the Web browser display (F5 key or "Refresh" button, for example).

# Standard Web server

## Web server user interface

All the Lexium Controller Web server pages have the same appearance:

1 A bar at the top containing links to HTML pages for the main menus: "Home", "Documentation", "Monitoring", "Control", etc.

This bar is the same regardless of which HTML page is being viewed.

**Note:** The "Control" and "Maintenance" menus are inoperative and grayed-out. They only appear because of the "Transparent Ready" common interface.

2 A menu down the left-hand side which displays links to the HTML pages available in the selected menu.

3 The center part of the window displays the information for the selected page.

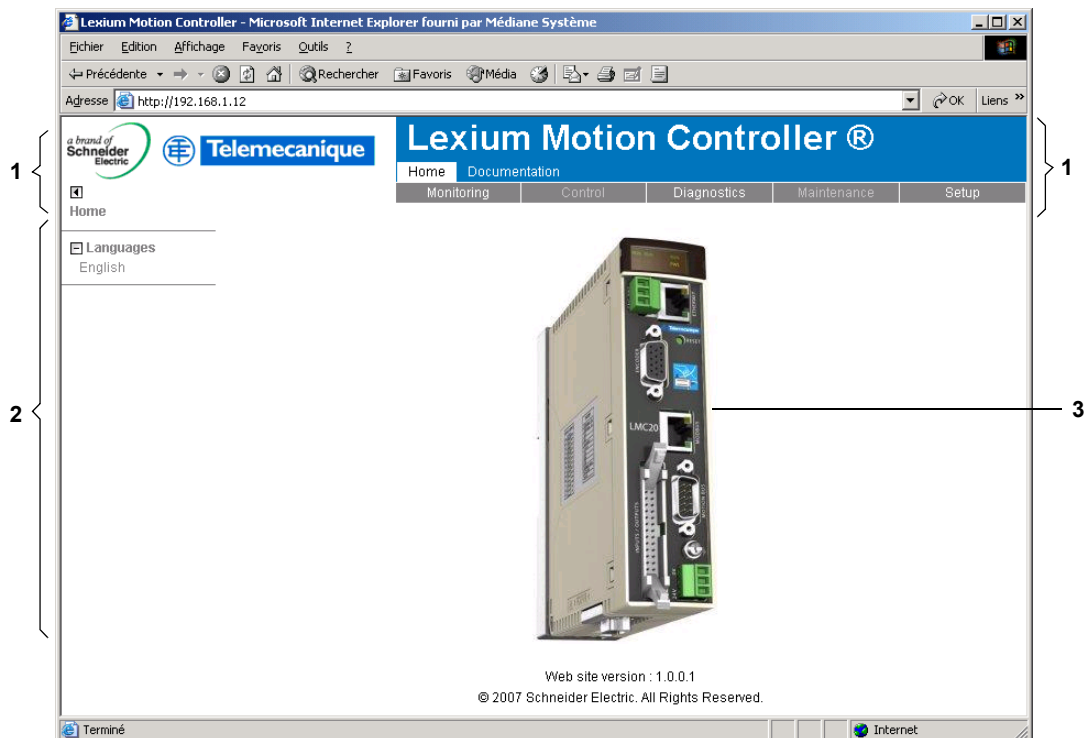

## "Home" menu

Number of Modbus TCP connections	0
----------------------------------	---

The home page or "Home" menu contains the following items:

- A "Languages" submenu containing:
  - A link to the "English" page

The single link available in the "Languages" submenu sends the user to the English home page and configures the Web browser to open the HTML pages located in the corresponding directory (e.g., the "http://139.160.69.241/html/english/" directory becomes the standard directory in the case of English).

# Standard Web server

## "Monitoring" menu

Number of Modbus TCP connections	0
----------------------------------	---

The "Monitoring" menu contains the following items:

- A link to the "LMC Viewer" page
- A link to the "Data Viewer" page
- A link to the "LMC Chart" page

Lexium Motion Controller - Microsoft Internet Explorer fourni par Médiane Système

Fichier Edition Affichage Favoris Outils ?

Précédente → Recherche Favoris Média

Adresse <http://192.168.1.12> OK Liens »

**Lexium Motion Controller**®  
Home Documentation

Monitoring Control Diagnostics Maintenance Setup

Monitoring

LMC Viewer

Data Viewer

LMC Chart



Web site version : 1.0.0.1  
© 2007 Schneider Electric. All Rights Reserved.

Internet



# Standard Web server

## "LMC Viewer" page

Number of Modbus TCP connections

Refresh period

This page gives an overview of the Lexium Controller status.

Lexium Motion Controller - Microsoft Internet Explorer

Fichier Edition Affichage Favoris Outils ?

Précédente Recherche Favoris

Adresse http://139.160.68.98/ OK Links

a brand of Schneider Electric Telemecanique Lexium Motion Controller®

Home Documentation

Monitoring Control Diagnostics Maintenance Setup

Monitoring

LEXIUM MOTION CONTROLLER

Device Name

Controller

CANopen

Motion Bus

Option Board

Encoder

DI0	TP1	DO0
DI1	TP2	DO1
DI2	EI1	DO2
DI3	EI2	DO3
DI4		DO4
DI5		DO5
DI6		DO6
DI7		DO7

© 2007 Schneider Electric. All Rights Reserved.

Applet LMCView started Local intranet

The status indicated in the "Controller" field corresponds to that of the Lexium Controller. A delay may sometimes be noticed between the displays on the Web server depending on the performance of the computer used to display the pages using a Web browser and the communication system performance.

The encoder value is displayed in the Encoder field.

Area DI... gives the state of the Lexium Controller terminals (logic inputs DI1 to DI8, logic outputs DO1 to DO8). When a logic input is active, the LED is green. When a logic output is active, the LED is red.

The OPTION field gives the reference of the integrated communication interface.

The CANopen and AXIS fields give the status of the CANopen and MOTION BUS networks.

# Standard Web server

## "Data Viewer" page

This page is used to display the Lexium Controller %MWxyz parameters and modify their values. The parameters are arranged into groups, consistent with those in the graphic display terminal and the manuals.

To start displaying the values of the parameters, click on the "Start animation" button:

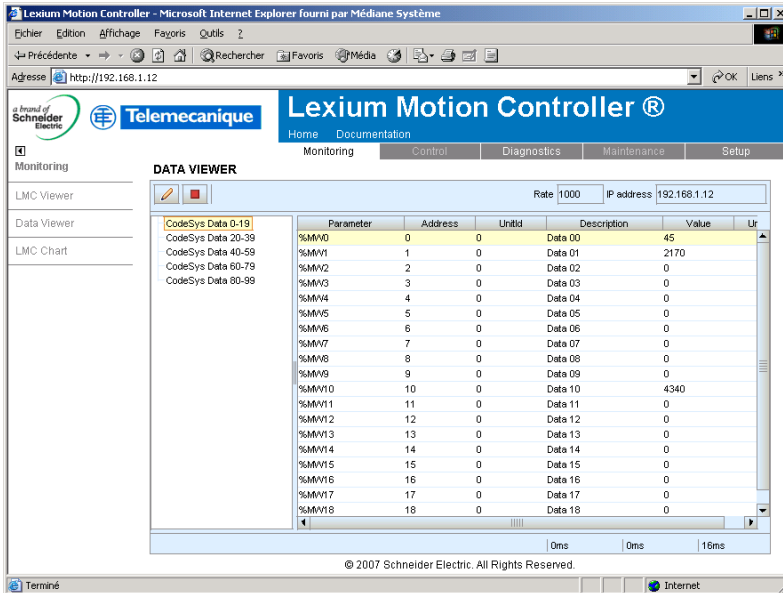

To modify parameter values, click on the "Write value of selected row" button then click on the value to be modified.

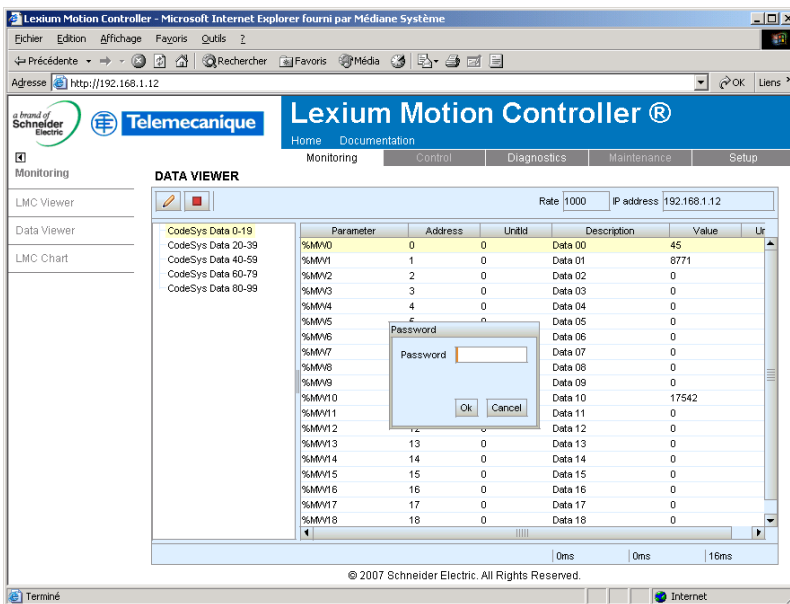

It is only possible to modify the parameter values after entering the Write password (see section entitled "["HTTP password" and "Data write password" pages](#)", page 37). After entering the password, press the Enter key so that it is taken into account by the Web browser. When a parameter value cannot be modified, a warning message appears: "This parameter can't be written!"

This is the case for all parameters until you have correctly entered the Write password. If IO Scanning has been enabled, modifying the value of a parameter assigned to periodic output variables will have no effect since this value is updated cyclically by the PLC. The same applies if a parameter is written periodically by a Modbus service.

# Standard Web server

## "LMC Chart" page

Number of Modbus TCP connections	1	Refresh period	1 s
----------------------------------	---	----------------	-----

This page is used to see how two Lexium Controller %MWxyz parameters evolve over time.

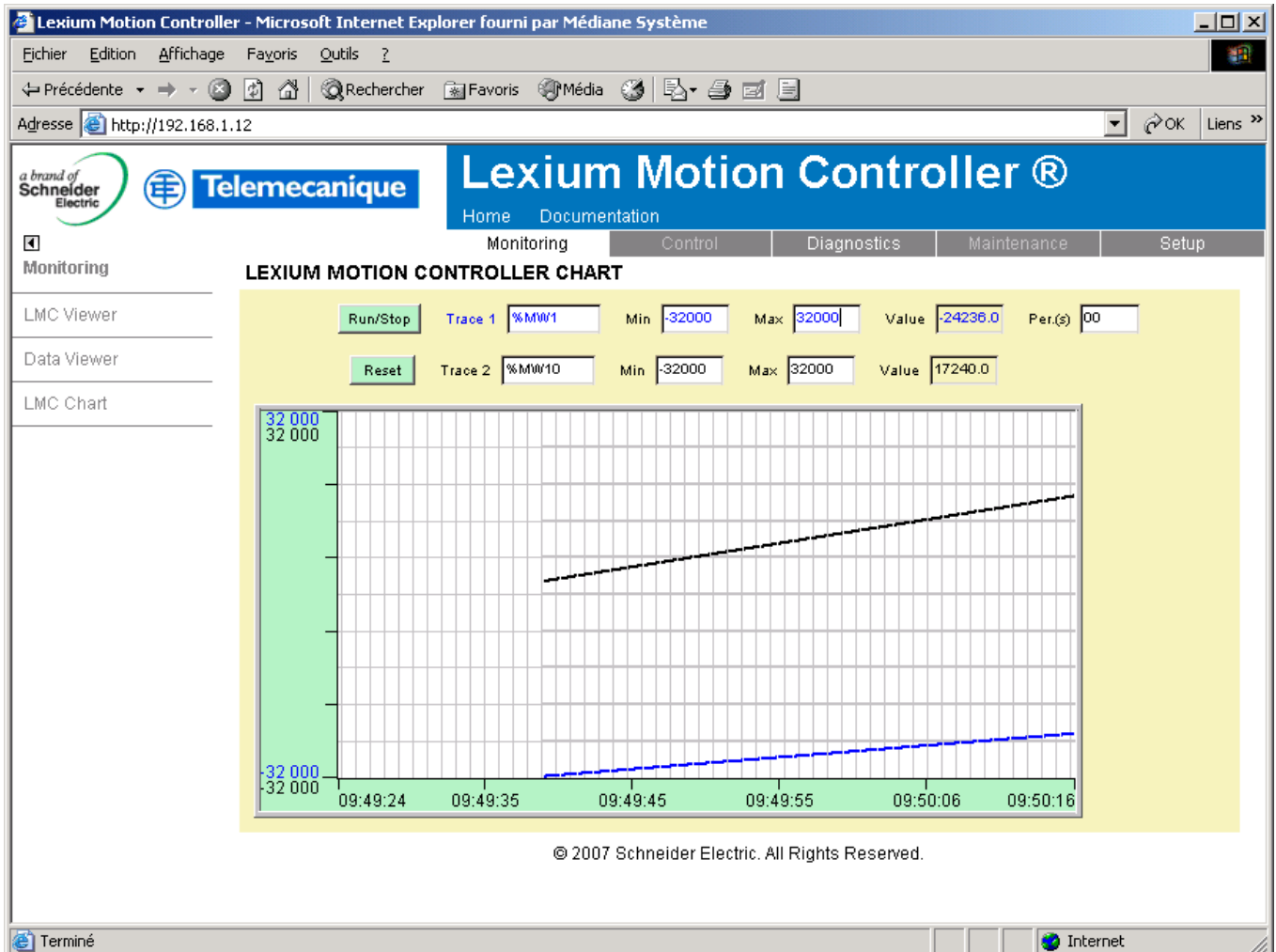

Two parameters can be selected and displayed simultaneously. To do this, select them in the **Trace1** and **Trace2** list.

To define the display range better, you can modify the curve min. and max. points by entering the values directly in the **Min** and **Max** fields of each trace.

To speed up sampling, the value 0 can be put in the **Intv(s)** entry field.

**Note:** Entering the value 0 increases the traffic on the Ethernet network and can cause collision problems if there is too much traffic, thereby reducing the overall network performance. The sampling period can be increased.

To start the oscilloscope function, press the **Run/Stop** button. Pressing the button again halts sampling and updates the screen.

**Reset:** Clears the active traces.

## "Diagnostics" menu

Number of Modbus TCP connections	0
----------------------------------	---

The "Diagnostics" menu contains the following item:

- A link to the "Ethernet Statistics" page

# Standard Web server

## "Ethernet Statistics" page

Number of Modbus TCP connections	1	Refresh period	0.5 s
----------------------------------	---	----------------	-------

This page provides the Ethernet statistics and the Lexium Controller identification data.

The screenshot shows the Lexium Motion Controller web interface in Microsoft Internet Explorer. The page title is "Lexium Motion Controller - Microsoft Internet Explorer fourni par Médiane Système". The address bar shows "http://192.168.1.12". The page features the Schneider Electric and Telemecanique logos, and a navigation menu with options: Home, Documentation, Monitoring, Control, Diagnostics, Maintenance, and Setup. The "Diagnostics" menu is selected, and the "Ethernet Statistics" sub-menu is active.

**ETHERNET & TCP-IP STATISTICS**

Device Name	UNDEFINED	Status	100 Mb/s
MAC Address	00-00-01-00-0a-00	Device Type	Motion Controller
IP Address	192.168.1.12	Device Reference	LMC20A1307
NetMask	255.255.255.0	Software Version	0.9ie01
Gateway	0.0.0.0	IP Configuration	Local

Emission statistics		Reception statistics		Other errors	
Emissions	13203	Receptions	14468	Collisions	0
Deferred Emissions	0	CRC Errors	0	Multi Collisions	0
Late Collisions	0	Frame Errors	0	Over Run	0
Buffer Errors	0	Buffer Errors	0	Error Messages	0
Emission Messages	3391	Reception Messages	3392	IO Scan Errors	0
IO Scan Emissions	0	IO Scan Receptions	0	Connexions (502)	1
Traffic (msg/s)	70	Max. Traffic (msg/s)	328		

Reset counters

© 2007 Schneider Electric. All Rights Reserved.

## "Setup" menu

Number of Modbus TCP connections	0
----------------------------------	---

The "Setup" menu contains the following items:

- A "Security" submenu containing:
  - A link to the "HTTP password" page
  - A link to the "Data write password" page

# Standard Web server

## "HTTP password" and "Data write password" pages

Number of Modbus TCP connections (for each page)	0
--	---

These two pages are used to modify the two Web server passwords.

By default, the username and both passwords are "USER" (upper case).

The username can only be modified using the Motion Pro/CoDeSys Browser workshop.

The username and the HTTP password are used to access the Web server in display mode.

The Write password is used to access the Web server in modification mode.

When the value of a parameter cannot be modified, the background of the corresponding cell appears grayed-out. This is the case for all parameters until you have correctly entered the Write password.

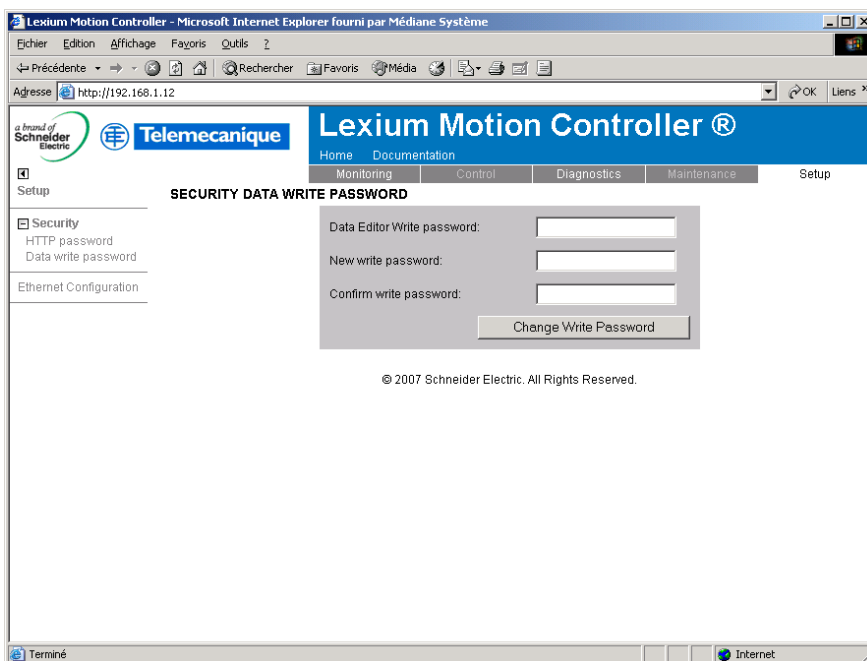
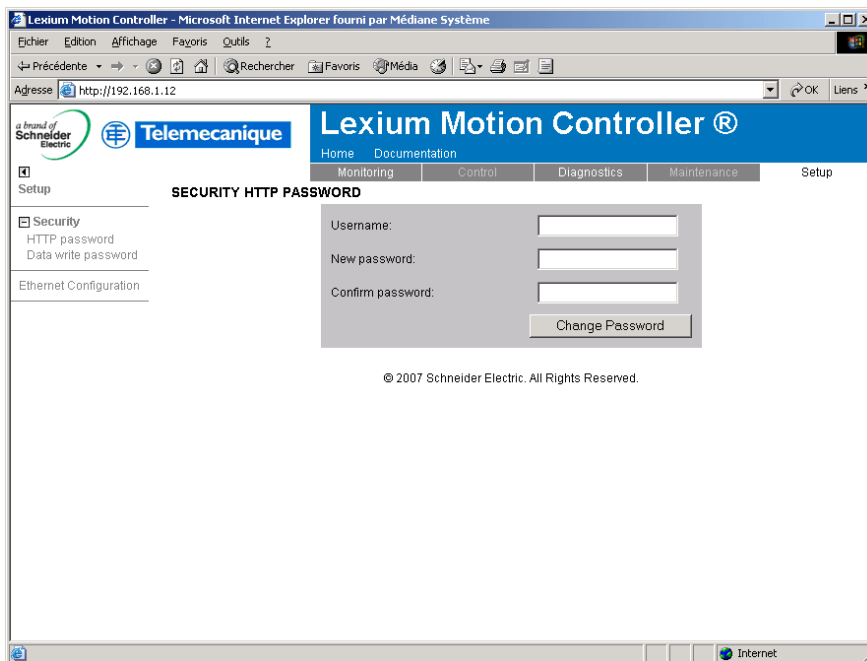

### NOTE:

**Do not lose the username or the passwords. If they are lost, the Web server can no longer be used, and the Lexium Controller has to be sent for repair.**

# Standard Web server

## "Ethernet Configuration" page

Number of Modbus TCP connections	1	Refresh period	1 s
----------------------------------	---	----------------	-----

This page is used to:

- Enable or disable IO Scanning
- Display and modify the assignment of the IO Scanning periodic variables
- Set the communication monitoring time out

The default configuration is described in the screen below:

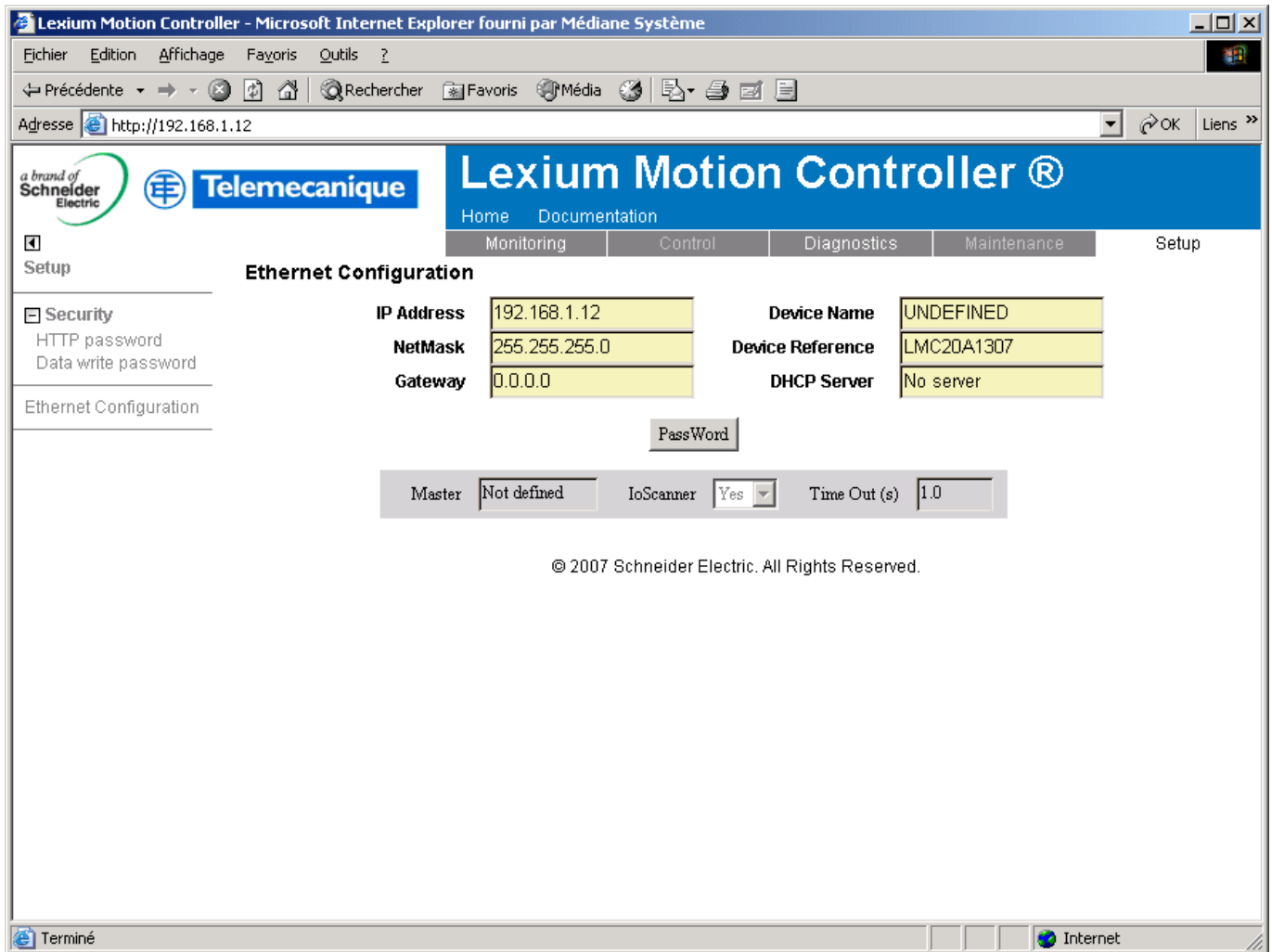

All modifications are protected by the Write password modification password. Click on the "PassWord" button to enter the Write password. After correctly entering the password, you can access "IoScanner", "Time Out (s)", "Master", "Output parameters", "Input parameters", and the "Save" and "Abort" buttons.

The default password is "USER". It can be modified in the "Data write password" page.

### ■ Enabling IO Scanning

Control by the IO Scanner is enabled if the "IoScanner" field is at the value "Yes" and disabled by the value "No".

**Note:** Disabling IO Scanning results in loss of data exchange if a PLC is using an IO Scanner.

Once the value in the "IoScanner" field has been modified, it may take a while to update the page, depending on the capacity of your computer.

# Standard Web server

---

## ■ Time out

This page also allows you to modify the communication monitoring time out. All data entries must be confirmed using the Enter key.

The following values are accepted:

0: No communication monitoring

0.5 to 60.0 s: Time out value

See the section entitled ["Communication fault", page 15](#).

The default time out value is 1 s (display: "1.0").

The "Time Out" field corresponds to the parameter.

## ■ Master

To configure this reservation, enter an IP address other than [\[0.0.0.0\]](#) in the "Master" field. This field is equivalent to the [\[IP Master\]](#) parameter.

# FTP Server

---

## ■ Access

The Ethernet interface has a structured FTP server that can be used to:

- Access the resource files of the embedded Web server

**To access to the FTP server, the Lexium Controller must be in STOP mode.**

Access to the FTP server is protected. To access the server, the user must enter a username and a password:

- The username is USER.
- The default HTTP password is USER. It can be changed via the standard Web server.

Address format in Internet Explorer: `ftp://USER:USER@xxx.xxx.xxx.xxx`



With some FTP clients, it is necessary to click "CANCEL" after connecting.

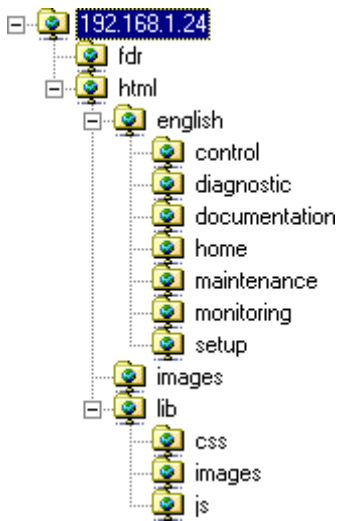

To obtain this display in Internet Explorer, first activate the "Enable FTP folder view" option (in: Tools, Internet Options ..., Advanced, Browsing).

The FTP server takes up to **2** FTP clients connected at the same time.



# FTP server

---

## ■ Functions

The following table describes the available functions:

FTP function	Comment
Username check. Accepts or rejects connection	Handled
HTTP password check. Accepts or rejects	Handled
User output	Handled
Type of file system	Handled. "DOS"
Create a volume or disk	Not handled
Change file name	Handled
Delete a file	Handled
Open a file	Handled in read/write mode
Read a file	Handled
Write a file	Handled
Close a file	Handled
Open a directory	Handled
Close a directory	Handled
Change directory	Handled
Current directory = parent directory	Handled
Delete a directory	Handled
Create a directory	Handled
Restore current directory	Handled
Read next directory input	Handled

## ■ File system

The whole "html" directory can be modified using the MD (make directory) and RD commands.

### NOTE:

**Before modifying the content of this directory, remember to save it to the hard disk on your PC. Do not modify this saved directory because in the event of a problem, you can use it to restore the original content of the FTP server "html" directory.**

The Ethernet interface manages the time and date of Web server file save operations.

# Web server downloads

## ■ Principle

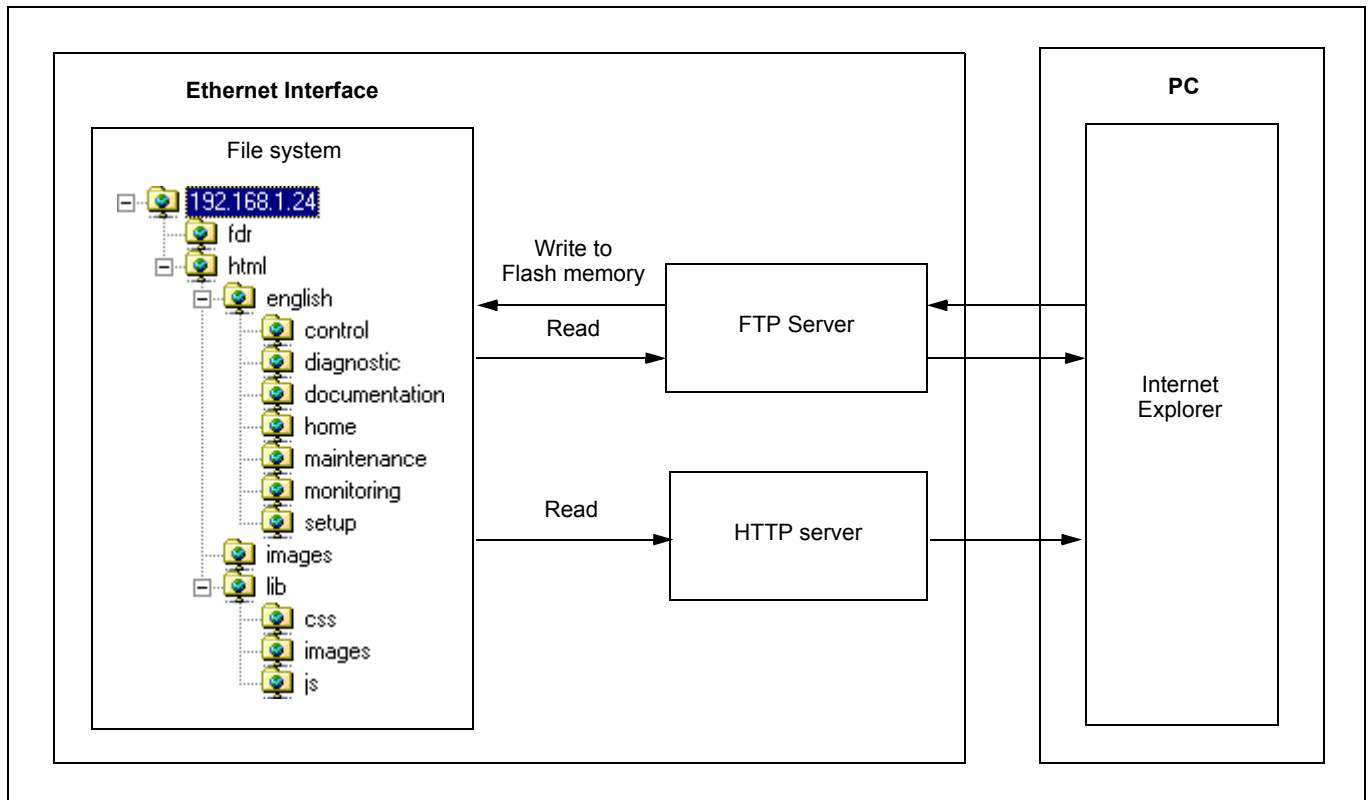

The Ethernet interface incorporates an FTP server that authorizes access to the various URLs available for the HTTP server. A browser, such as Internet Explorer, can be used to display the URLs as a disk in Windows explorer. This "disk" consists of various directories containing the URL files. It is therefore possible to use the different commands managed by the explorer such as deletion, renaming or writing (downloading) files (check that IO Scanning has been disabled on the interface).

## ■ File management

The memory zone assigned to the Web server URLs consists of 12 accessible blocks:

- 12 sectors of 64 Kb for file storage

The Web server storage capacity is 512 Kb.

**If additional pages are downloaded to the Lexium Motion Controller in order to modify the Web server, the memory space reserved for the Motion Pro/CoDeSys programs is reduced by the amount of memory space used by the new Web pages.**

The file table is used to make the link between the HTTP server, the FTP server and the various "URL" files. This table is dynamic, in other words it changes according to the file write and file delete type user commands. The table is cleared and reprogrammed each time there is a change.

The maximum number of URL files is limited to 150.

The information relating to each file is as follows:

- File name (**32 characters max.**)
- Location address in the interface memory
- File size in bytes
- "FTP" storage directory (html, html/lib/js, etc.)
- URL processing function. (Access management, etc.). All the URLs have a default function which requires an HTTP password in order to access them via HTTP, apart from a few exceptions (see below).

# Web server downloads

---

Each HTTP server URL is stored in the file table. As a result, the user can easily change the standard Web server by adding, deleting or modifying the URL files.

However, some URLs are compulsory and/or cannot be modified.

- The "index.htm", "html/english/home/index.htm" and "html/english/home/home.htm" pages, which form the entry page to the Web server, are compulsory.
- The WebServer.htm page (see later), and the various HTML requests, such as password modification, are fixed and are not visible via the FTP server.

The maximum file size is limited to **64 Kb**. The size of the AtvSys.jar java archive file, containing all the java applets, is almost 64 Kb. If additional java applets are required, two archive files must be created.

## ■ Web server

The Web server has a masked page, which cannot be accessed directly via a hyperlink, providing access to a summary of the memory resources, sector by sector, used by the Web server.

Example of access: <http://192.168.1.23/WebServer.htm>

Memory Sector	Free (bytes)	Max (bytes)	FastFree (bytes)	# File
Sector 23	65,536	65,536	65,536	00
Sector 24	65,536	65,536	65,536	00
Sector 25	65,536	65,536	65,536	00
Sector 26	65,536	65,536	65,536	00
Sector 27	65,536	65,536	65,536	00
Sector 28	65,536	65,536	65,536	00
Sector 29	65,536	65,536	65,536	00
Sector 30	65,536	65,536	65,536	00
Sector 31	65,536	65,536	65,536	00
Sector 32	65,536	65,536	65,536	00
Sector 33	65,536	65,536	65,536	00
Sector 34	65,536	65,536	65,536	00
TOTAL	524,288	524,288	524,288	0

# Setup using PL7

## ■ Defining the hardware configuration

Configure an Ethernet module, then configure the module so that it can communicate with the Lexium Controller. The example shows a TSX Premium PLC equipped with a TSX ETY5102 module.

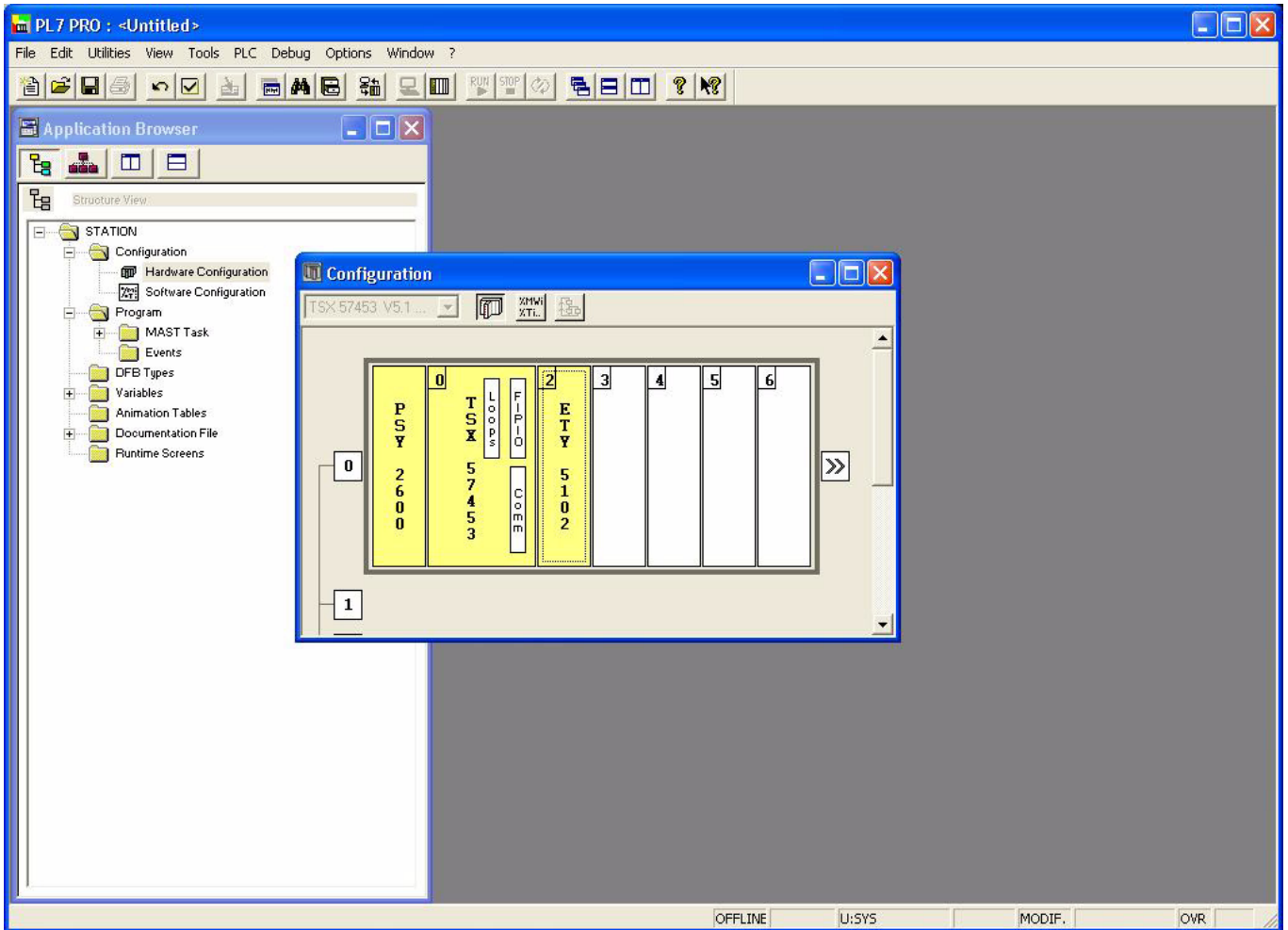

# Setup using PL7

## ■ BOOTP configuration

The BOOTP server function consists of allocating BOOTP clients their IP addresses.

The activation conditions for the Lexium Controller BOOTP client are described in the "Configuration - IP Addresses" section.

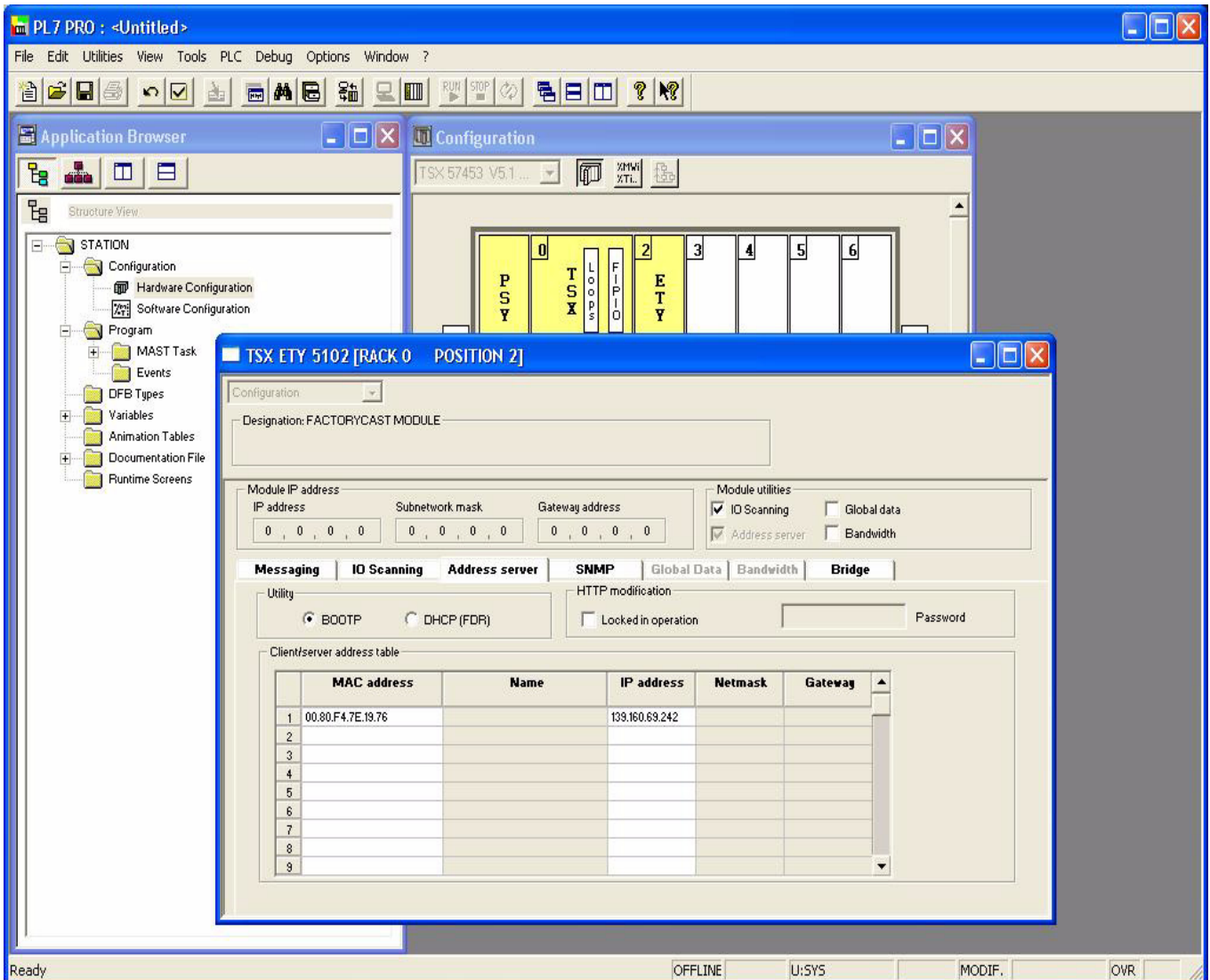

This window is used to configure the BOOTP server.

The MAC address of the Lexium Controller is given on a label attached to the Lexium Controller. The IP address assigned to the Lexium Controller must be entered in the table against the MAC address.

In this example, MAC address of the Ethernet connection is 00.80.F4.7E.19.76, and its IP address is 139.160.69.242.

Each line in the "Table of supplied addresses" can accept both the MAC and IP addresses of a BOOTP client.

# Setup using PL7

## ■ Configuring Modbus messaging

To use Modbus messaging in PL7, the "IP address", "Subnet mask" and "Gateway address" parameters must be configured in the "Messaging" tab in the PLC Ethernet module configuration screen.

Data entered in the "Connection configuration" box is used to manage the PLC Modbus messaging service, but has no effect on IO Scanning which is an independent service.

Example:

PLC IP address	139.160.69.245
Subnet mask	255.255.254.0
Gateway address	139.160.68.1
Lexium Motion Controller IP address	139.160.69.242

	Xway address	IP address	Protocol	Access	Mode
1	1.101	139.160.69.242	MODBUS	<input checked="" type="checkbox"/>	MULTI

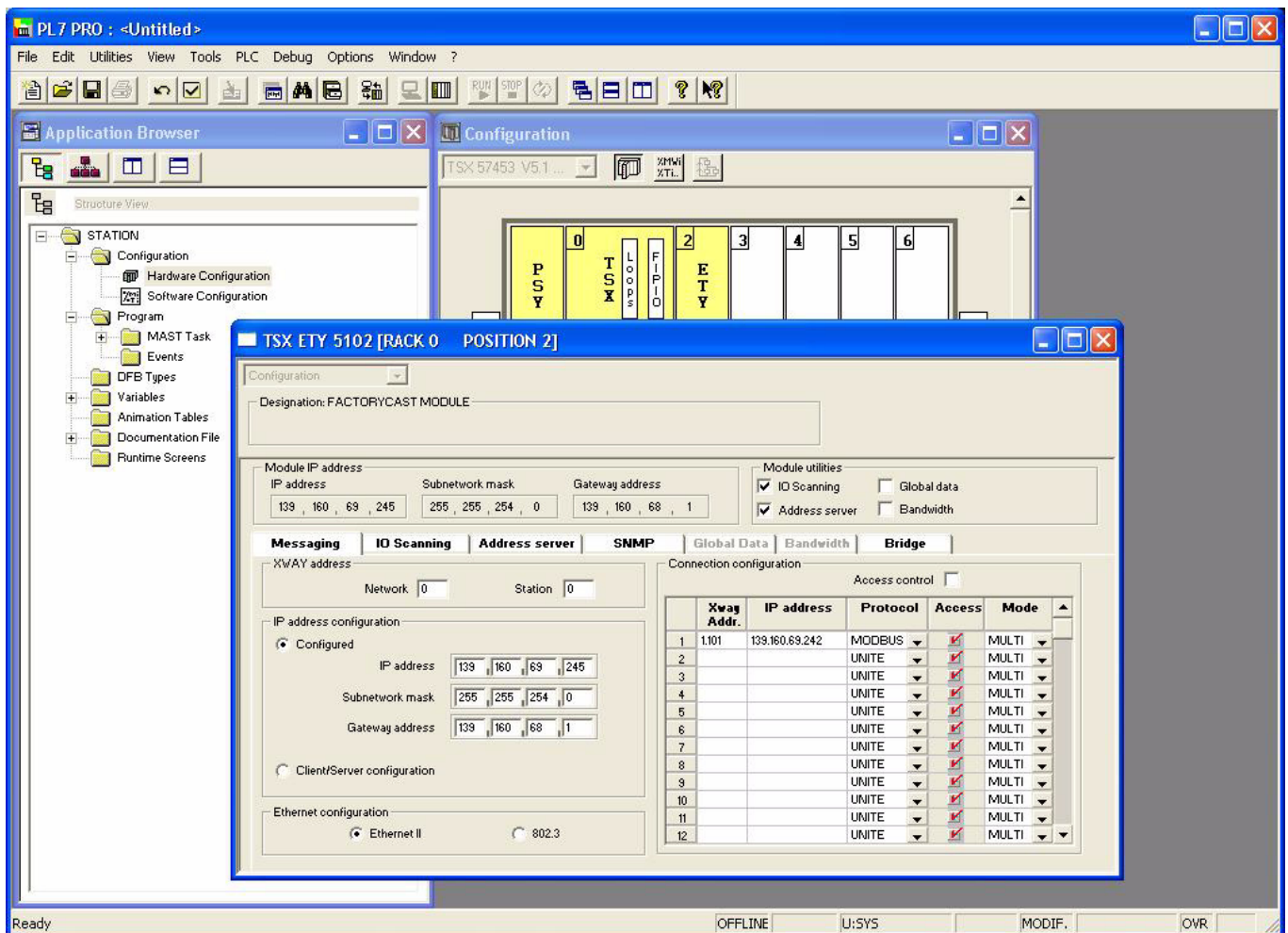

# Setup using PL7

## ■ Configuring periodic variables

This window is used to configure the IO Scanning function, described in the IO Scanning Service section on page 26. In this example:

- The periodic variables of the Lexium Controller at IP address 139.160.69.242 are associated with PLC data words.
- The Lexium Controller periodic output variables (control) are associated with the 11 words (WR count) starting at PLC address %MW550 (Write Ref.).
- The Lexium Controller periodic input variables (monitoring) are associated with the 11 words (RD count) starting at PLC address %MW500 (Read Ref.).

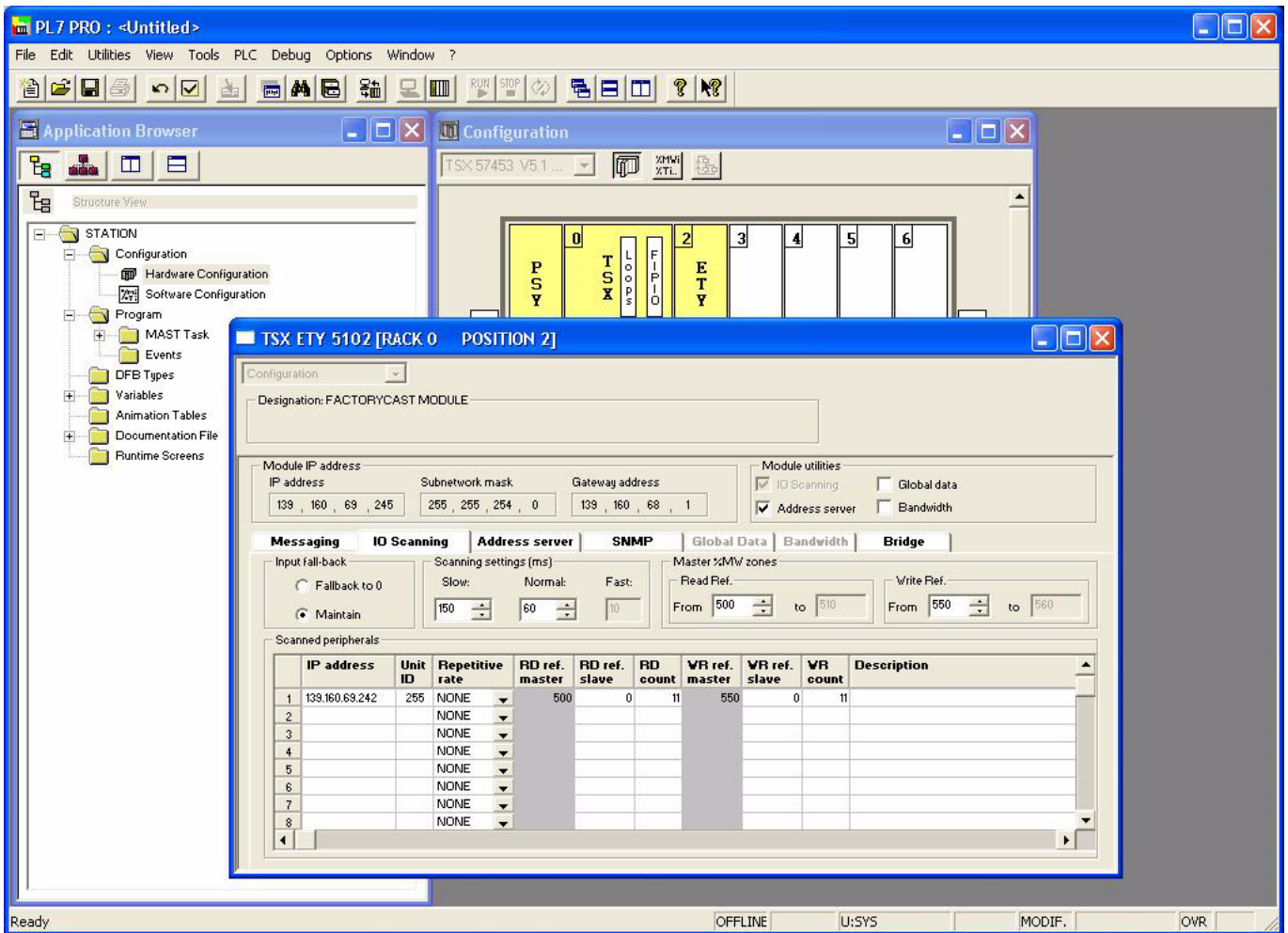

## Setup using PL7

---

The addresses for the PLC %MW words correspond to the configuration in the previous example.

PLC address	Periodic output variable (default assignment)	%IW
%MW 550	Reserved	2
%MW 551	Not assigned	3
%MW 552	Not assigned	4
%MW 553	Not assigned	5
%MW 554	Not assigned	6
%MW 555	Not assigned	7
%MW 556	Not assigned	8
%MW 557	Not assigned	9
%MW 558	Not assigned	10
%MW 559	Not assigned	11
%MW 560	Not assigned	12

PLC address	Periodic input variable (default assignment)	%QW
%MW 500	Reserved	1
%MW 501	Not assigned	2
%MW 502	Not assigned	3
%MW 503	Not assigned	4
%MW 504	Not assigned	5
%MW 505	Not assigned	6
%MW 506	Not assigned	7
%MW 507	Not assigned	8
%MW 508	Not assigned	9
%MW 509	Not assigned	10
%MW 510	Not assigned	11



# Setup using PL7

## ■ Configuring the DHCP address server (FDR)

The DHCP server function consists of allocating BOOTP clients an IP address.

The activation conditions for the Lexium Controller DHCP client are described in the "Configuration - IP Addresses" section.

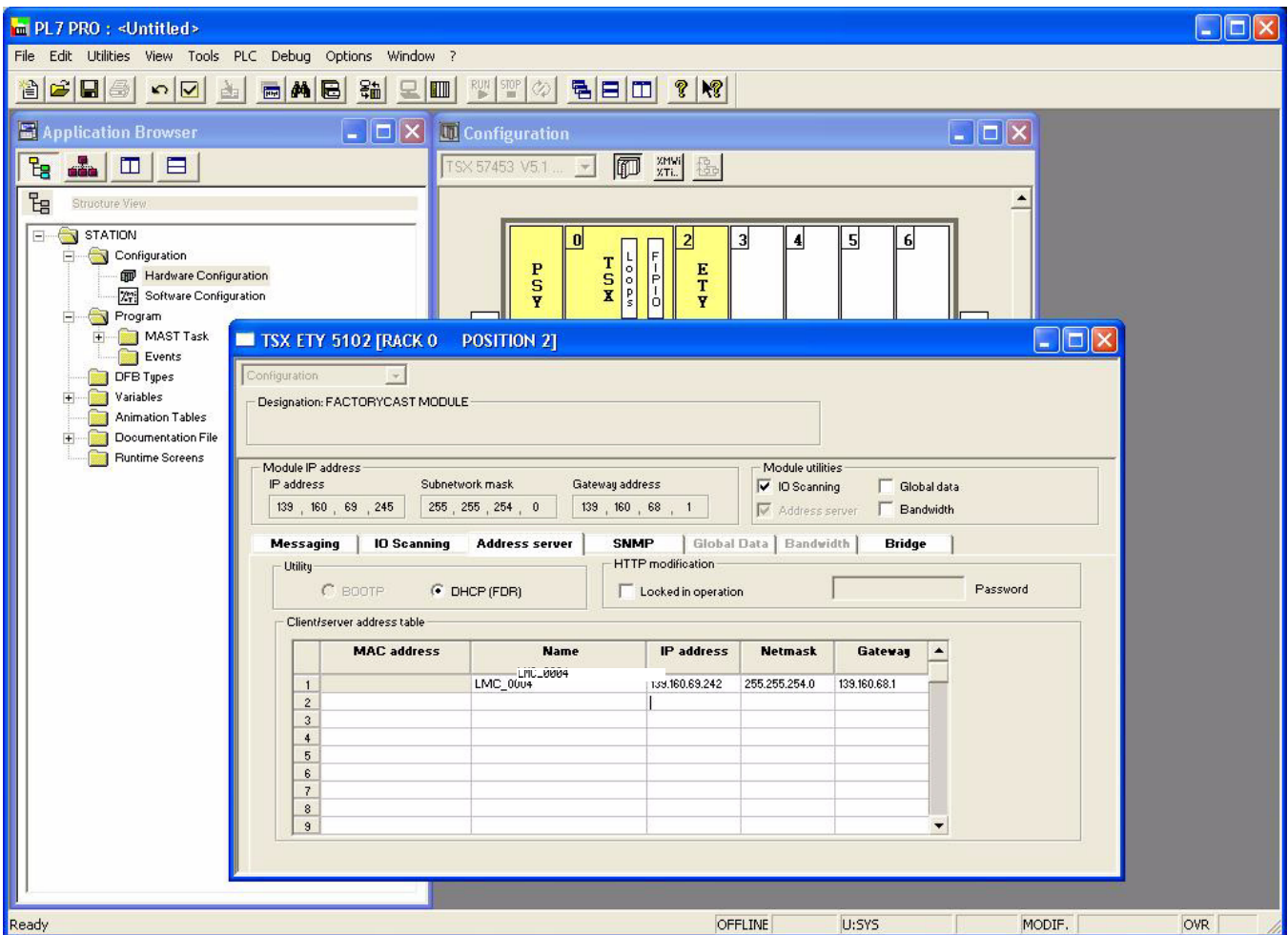

This window is used to configure the DHCP server.

The user must enter the following fields:

- "Name" to indicate the device name. In our example the name of the Lexium Controller is "LMC\_0004". This "name" corresponds to the DHCP function DeviceName and the parameter [DEVICE NAME].
- "IP address" to indicate the device IP address. In our example the Lexium Controller IP address is "139.160.69.242"
- "Netmask" to indicate the subnet mask. In our example the subnet mask is "255.255.254.0"
- "Gateway" to indicate the gateway IP address. In our example the gateway IP address is "139.160.68.1"

Each line in the "Table of supplied addresses" can accept both the names and IP addresses of a DHCP client.



# Setup using ProWORX NxT

## ■ Hardware configuration (Traffic Cop)

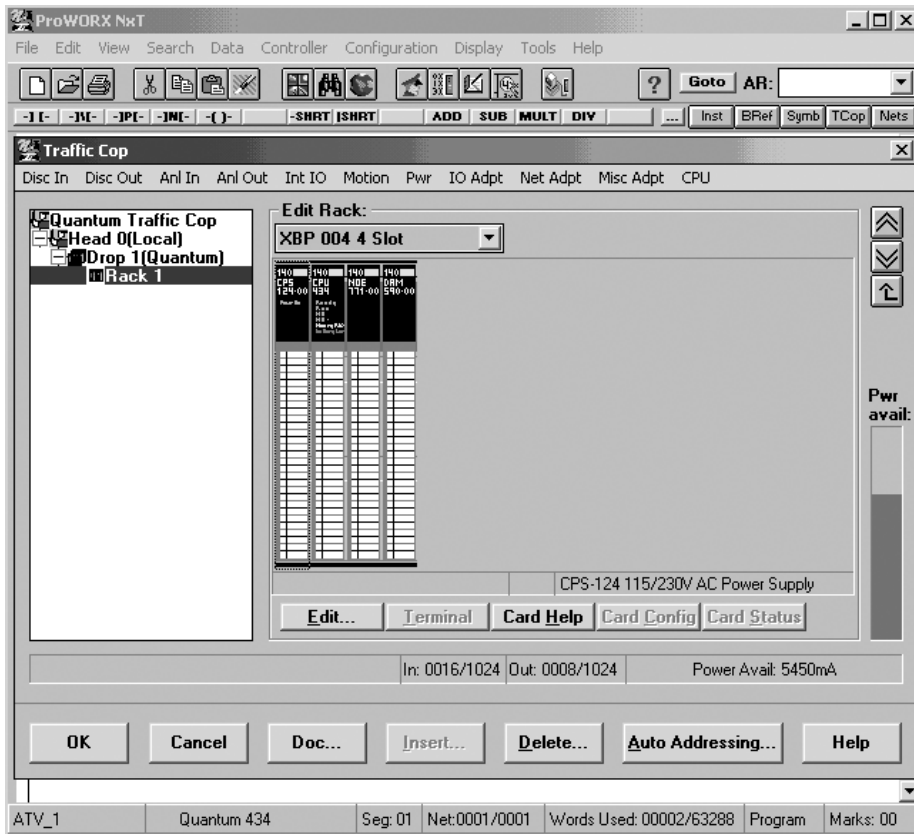

## ■ Network configuration

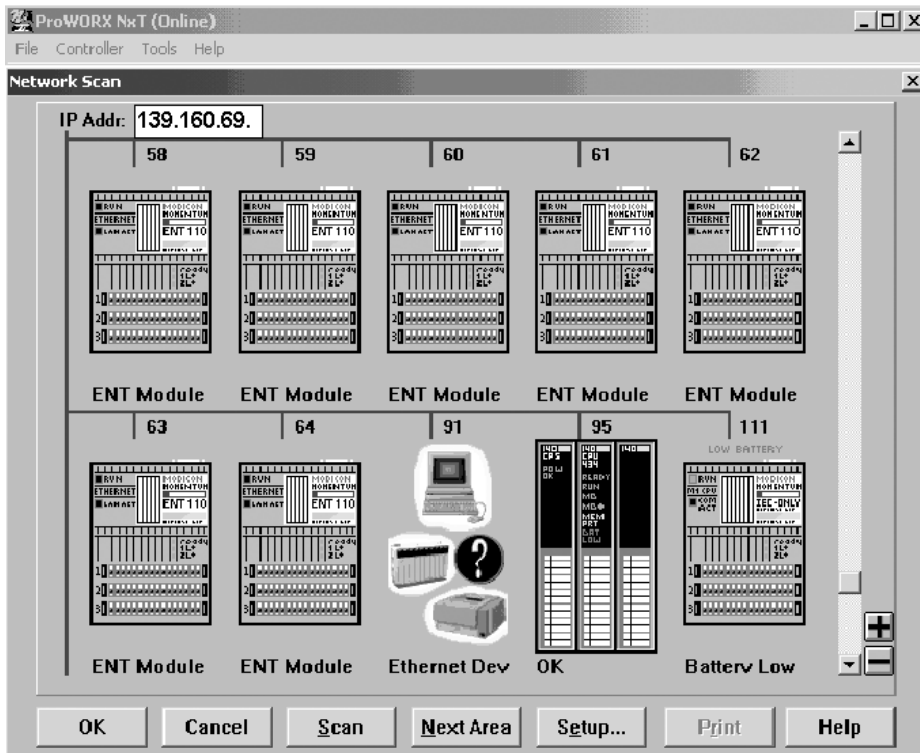

# Setup using ProWORX NxT

## ■ TCP/IP configuration

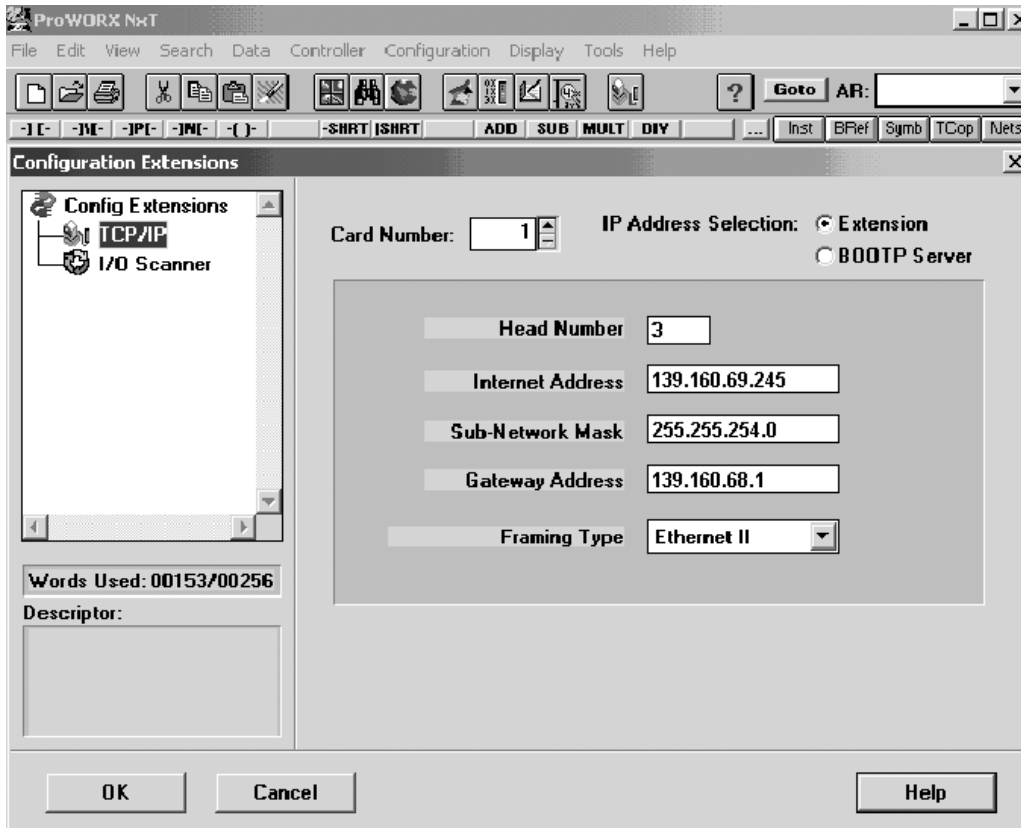

## ■ I/O Scanner configuration

