

MEDAMEDA

ZMM646

Termostatico incasso doccia con deviatore 2/3 vie. / Built-in thermostatic shower mixer, 2/3 way diverter.



Termostatico incasso doccia da 1/2" e deviatore a 2/3 vie con apertura/chiusura acqua.

1/2" built-in thermostatic shower mixer and 2/3 way diverter with water on/off function.

R97810

Parte incasso termostatico 2 vie / Built-in part -
2 way thermostatic mixer











R97815

Parte incasso termostatico 3 vie / Built-in part -
3 way thermostatic mixer



Finiture / Finishes

						
Cromo / Crhome	Nickel Spazzolato / Brushed Nickel	Nickel Lucido / Polished Nickel	Oro / Gold	Oro spazzolato / Brushed Gold	Metal Black / Metal Black	Metal Black spazzolato / Brushed Metal Black
						
N1						
Nero Opaco Goffrato / Embossed Matt Black						

MEDAMEDA

ZMM646

Disegno Complessivo / Overall Drawing

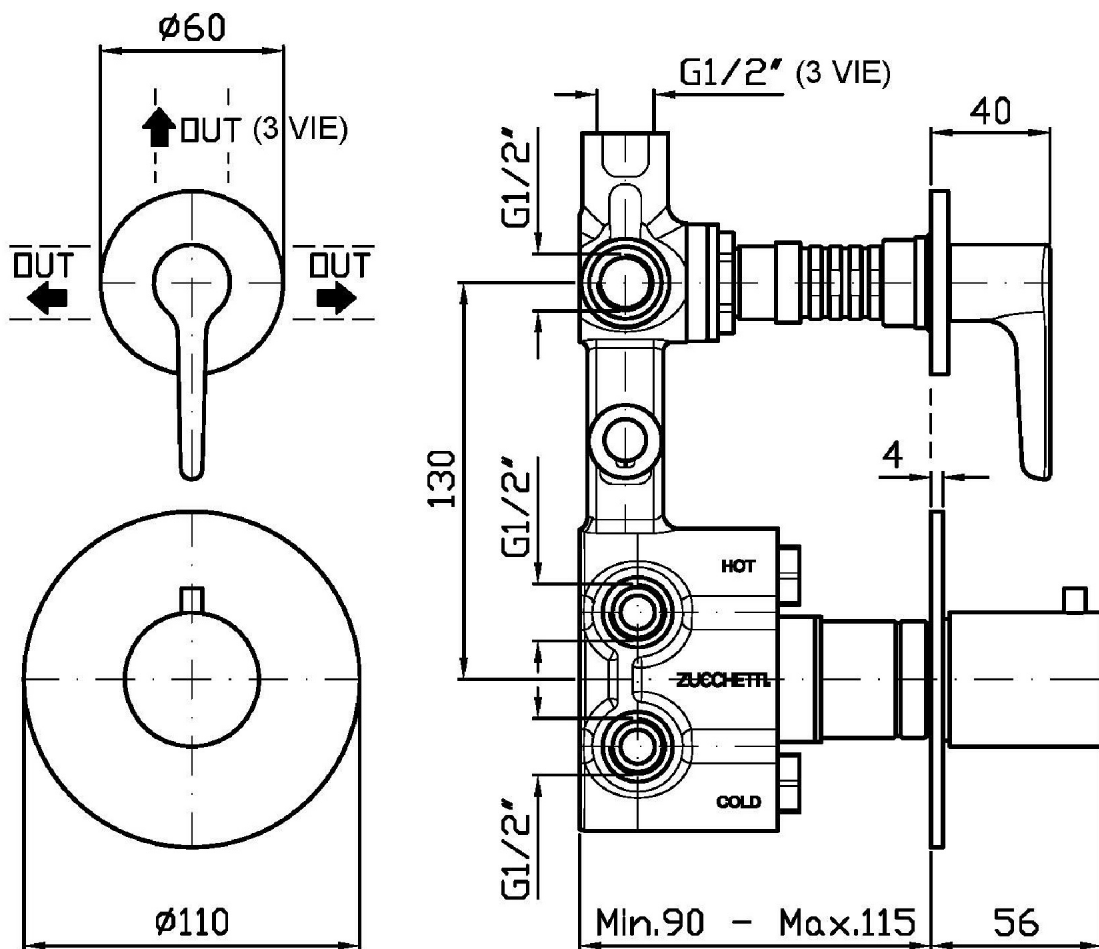

MEDAMEDA

ZMM646 Portate / Flowrates (lt/min)

PRESSIONE PRESSURE	1 BAR	2 BAR	3 BAR	4 BAR	5 BAR
DEVIATORE <i>P1</i>	11,5	16,2	19,5	23,2	26
<i>P2</i>					
<i>P3</i>					
<i>P4</i>					
<i>P5</i>					

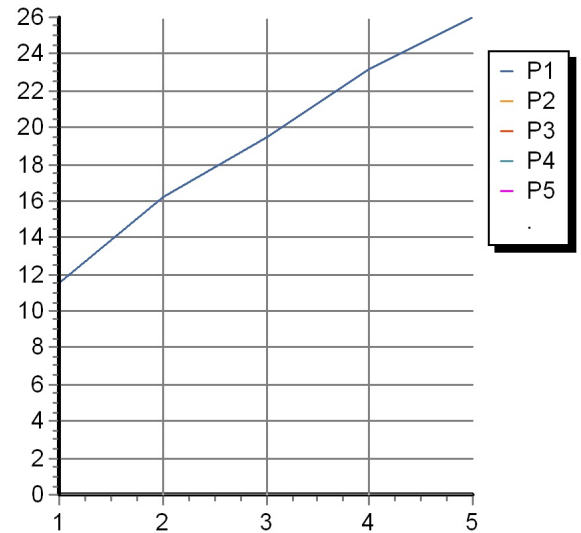

MEDAMEDA

ZMM646 Pesì e Misure / Weights and Sizes

Peso (Kg) Weight (lb)	1,37 (Kg)	3,02 (lb)
Volume test (dc3) - (in3)	5,68 (dc3)	346,61 (in3)
h (mm) - (in)	75,00 (mm)	2,95 (in)
L1 (mm) - (in)	180,00 (mm)	7,09 (in)
L2 (mm) - (in)	420,00 (mm)	16,54 (in)

