

# KOHLER® Faucets 14" rainhead with Katalyst® air-induction technology, 2.5 gpm K-13691

## Features

- Single-function rain showerhead.
- MasterClean® spray nozzles to prohibit mineral build-up for easy cleaning.
- Katalyst® Spray Technology with air induction ball joint.
- Optimized sprayface for maximum performance.
- Solid brass construction for durability and reliability.
- 2.5 gpm (9.5 lpm) maximum flow rate.
- 1/2" - 14 NPT connection.



## Recommended Products/Accessories

K-23723 Faucet cleaner

## Codes/Standards







ASME A112.18.1/CSA B125.1  
DOE - Energy Policy Act 1992

## KOHLER® Faucet Lifetime Limited Warranty

See website for detailed warranty information.

## Available Colors/Finishes

*Color tiles intended for reference only.*

Color	Code	Description
	CP	Polished Chrome
	SN	Vibrant® Polished Nickel
	PGD	Vibrant® Moderne Polished Gold
	BN	Vibrant® Brushed Nickel
	BV	Vibrant® Brushed Bronze
	TT	Vibrant Titanium

**KOHLER** Faucets 14" rainhead with Katalyst® air-induction technology, 2.5 gpm  
K-13691

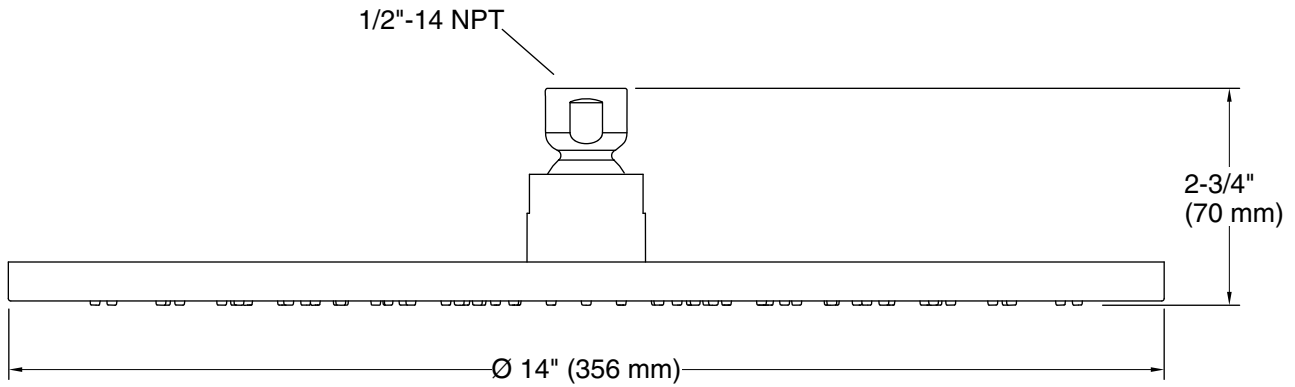

**Technical Information**

All product dimensions are nominal.

**Notes**

Install this product according to the installation instructions.