

Features

- Single-speed whirlpool offers performance and value, with 6 fully adjustable jets.
- Hydromassage flow and direction can be controlled at each jet.
- Built-in heater.
- Generous 6-foot length provides an incredibly spacious bathing area.
- Hourglass shape adds style and elegance to your bathroom.
- Integral flange helps prevent water from seeping behind wall and simplifies alcove installation.
- Textured bottom surface.

Material

- Acrylic.

Hydrotherapy

- Whirlpool.

Installation

- Left drain.
- Alcove.

Recommended Products/Accessories

- K-1283 Removable Apron
- K-1491 Bath/Whirlpool Pillow
- K-24916 Wireless Music Kit
- K-7213 27" Cable Bath Drain
- K-7214 27" Cable Bath Drain
- K-7259 Clearflo Bath Drain
- K-23726 Drain treatment
- K-23732 Tub & shower cleaner
- K-37380 30" Rough-in Cable Bath Drain
- K-37383 Rough-in cable bath drain, PVC, 30" cable with tubing
- K-7265 Clearflo Bath Drain
- K-37386 rough-in cable drain, PVC, 30" cable



Codes/Standards





ASME A112.19.7/CSA B45.10
CSA B45.5/IAPMO Z124
ASTM E162
ASTM E662
UL 1795

**KOHLER® Plastic Baths and Receptors
Lifetime Limited Warranty
KOHLER® Hydrotherapy Components
Five-Year Limited Warranty**

See website for detailed warranty information.

Available Colors/Finishes

Color tiles intended for reference only.

Color	Code	Description
	0	White
	96	Biscuit
	47	Almond
	NY	Dune
	G9	Sandbar

Pump/Control Access (If Apron Is Not Used):
20" (508 mm) W x 15" (381 mm) H

No change in measurements if connected with
drain illustrated. (K-11677)

□ Recommended Faucet Location

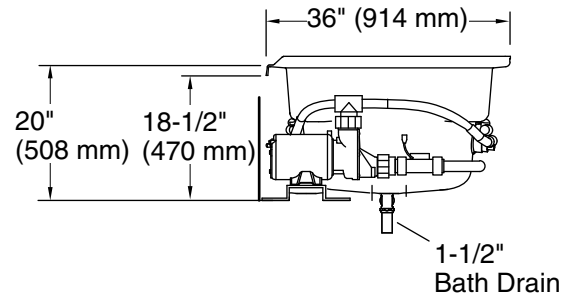
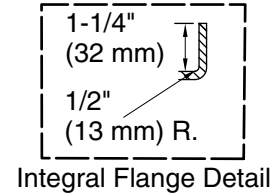
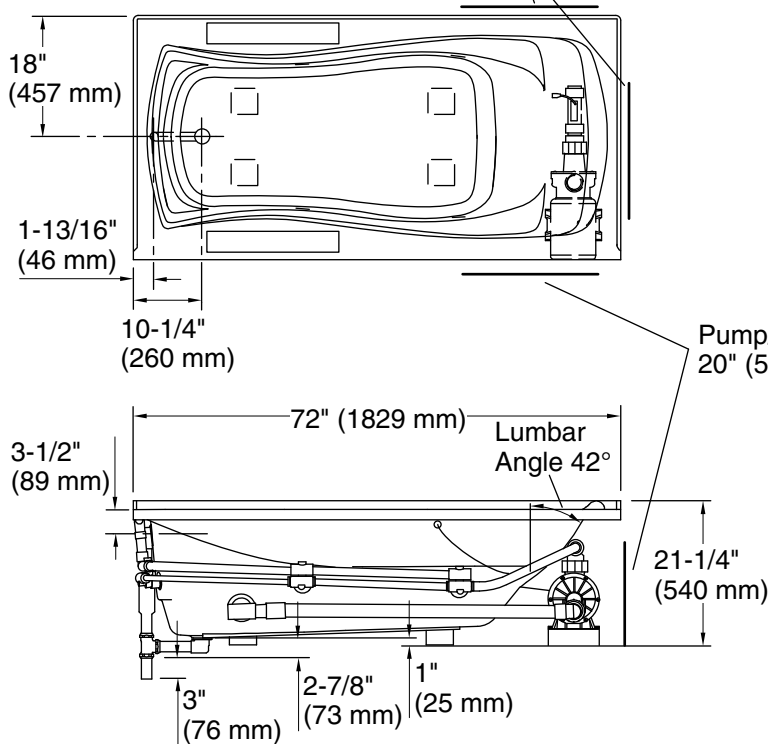

Required Electrical Service

Two dedicated circuits required, protected with Class A Ground-Fault Circuit-Interrupter (GFCI). Outside North America, this device may be known as a Residual Current Device (RCD).

Pump: 120 V, 15 A, 60 Hz
Heater: 120 V, 15 A, 60 Hz

Technical Information

All product dimensions are nominal.

Installation: Three-wall alcove
Drain location: Left
Basin area, bottom: 50" x 24" (1270 mm x 610 mm)
Basin area, top: 65" x 27" (1651 mm x 686 mm)
Weight: 115 lbs (52.2 kg)
Minimum floor load: 41 lbs/ft² (200.2 kg/m²)
Water depth: 14" (356 mm)
Water capacity: 72 gal (272.5 L)
Electrical component rating: Pump: 120 V, 7.5 A, 60 Hz
Heater: 120 V, 12.5 A, 60 Hz, 1500 W
Pump speed: Single
Minimum flat for door: 2-1/8" (54 mm)

Notes

Measure your actual product for rough-in details. Install this product according to the installation instructions.

The hot water supply should be 70% of the capacity of the bath or greater. Installations will vary.

If installing a rim-mount faucet, make sure there is no interference above or below the deck before drilling any holes.