

Model/Modelo/Modèle
35765LF-▲PD
Series/Series/Seria

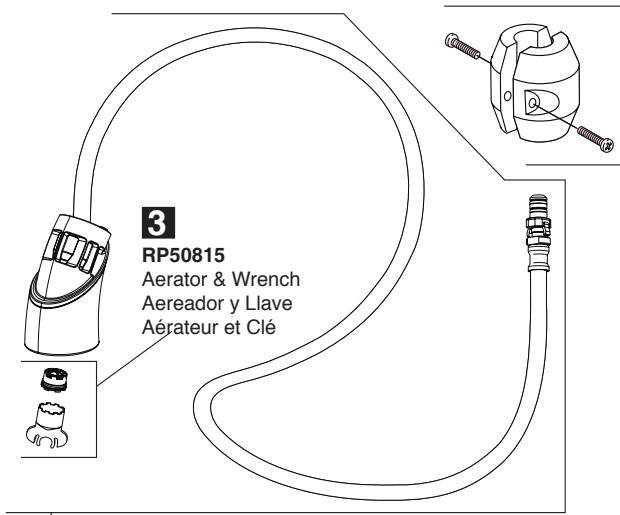

3
RP50815
Aerator & Wrench
Aerador y Llave
Aérateur et Clé

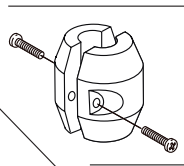

RP63207
Zinc Weights and Screws
Pesas de Cinc y Tornillos
Poids en plomb et vis

RP100232▲
Handle Assemblies
Conjunto de manija
Montage de la manette

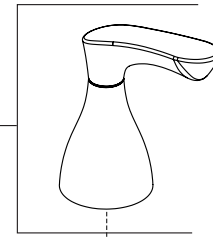

RP74418
Stem Unit Assembly, Seat & Spring,
Bonnet Nut & Washer
Ensamble de la Unidad del Vástago,
Asiento y Resorte, Bonete y Arandela
Obturbador, siège et ressort, écrou à
chapeau et rondelle

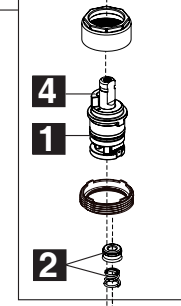

4
1
2

RP100523▲
Hose Assembly, Wand, Clip & O-Rings
Montaje de la manguera, varita, clip & O-rings
Ensemble de tuyaux, baguettes, clips et joints
toriques

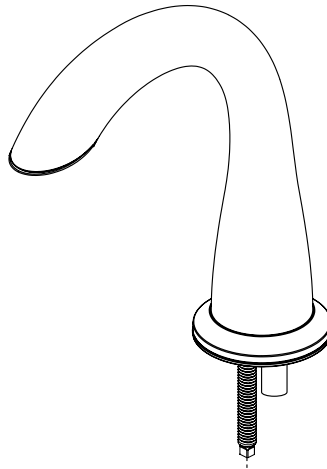
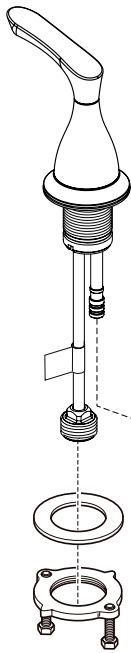

RP60925
Gasket, Washer & Nut
Empaque, Arandela y Tuerca
Joint, Rondelle et Écrou

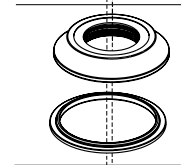
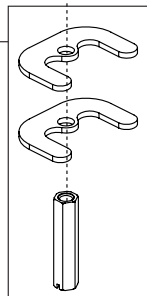

RP100524▲
Flanges (2) & Gaskets (2)
Brida (2) y Empaques (2)
Bride (2) et Joints (2)

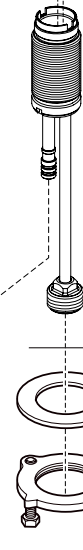

RP47423
Washers (2), Nuts (2)
& Screws (4)
Arandelas (2), Tuercas (2)
y Tornillos (4)
Rondelles (2), Écrous (2)
et Vis (4)

RP100526
Hose Assembly,
Blocks & O-Rings
Ensamble de la
manguera, Bloques
y Aros-O
Tuyau souple,
blocs de fixation
et joints toriques

RP60121
Blocks & O-Rings
Bloques y Aros-O
Blocs de fixation
et joints toriques

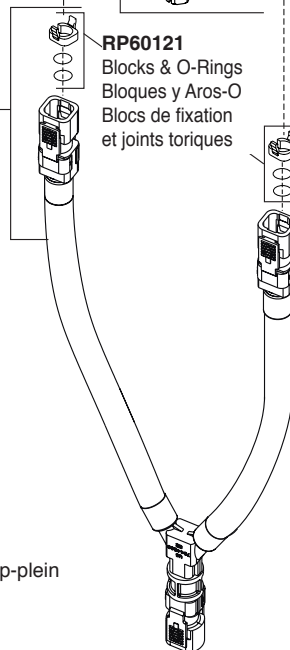

RP100137
Push Pop-UP with Overflow
Control de rebose para
desagües manuales
Mécanique à poussoir avec trop-plein

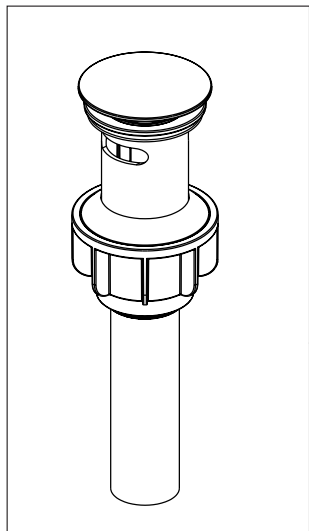

▲ Specify Finish
Especifíquelo el Acabado
Précisez le Fini