







| A | B | C | D | E | F | G |
|---|---|---|---|---|---|---|
|  |  |  |  |  |  |  |
| 1PCS | 2PCS | 2PCS | 8PCS $\phi 8 / \phi 19 \times 2$ | 8PCS M8+35 | 1PCS 5mm | 4PCS |

FIG.
1

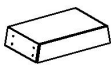
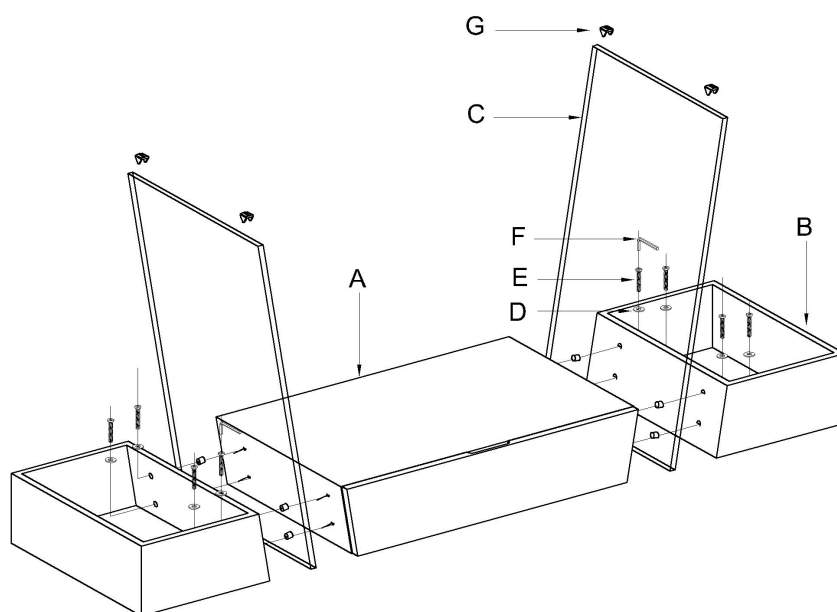

FIG.
2

