

Marchio / Brand ZUCCHETTI

Classe / Class WW

PAN

ZT28662

Termostatico incasso doccia con 4 rubinetti d'arresto. / Built-in therm. shower mixer 4 stop valves.



Termostatico incasso doccia da 1/2", con 4 rubinetti d'arresto.









1/2" built-in thermostatic shower mixer with 4 stop valves.

R97823

Parte incasso. / Built-in part.



Finiture / Finishes

						
Cromo / Crhome	Nickel Spazzolato / Brushed Nickel	Nickel Lucido / Polished Nickel	Oro / Gold	Oro spazzolato / Brushed Gold	Metal Black / Metal Black	Metal Black spazzolato / Brushed Metal Black
						
Bianco Opaco Goffrato / Embossed Matt White	Nero Opaco Goffrato / Embossed Matt Black	Nero Soft Touch / Soft Touch Black				

PAN

ZT28662

Disegno Complessivo / Overall Drawing

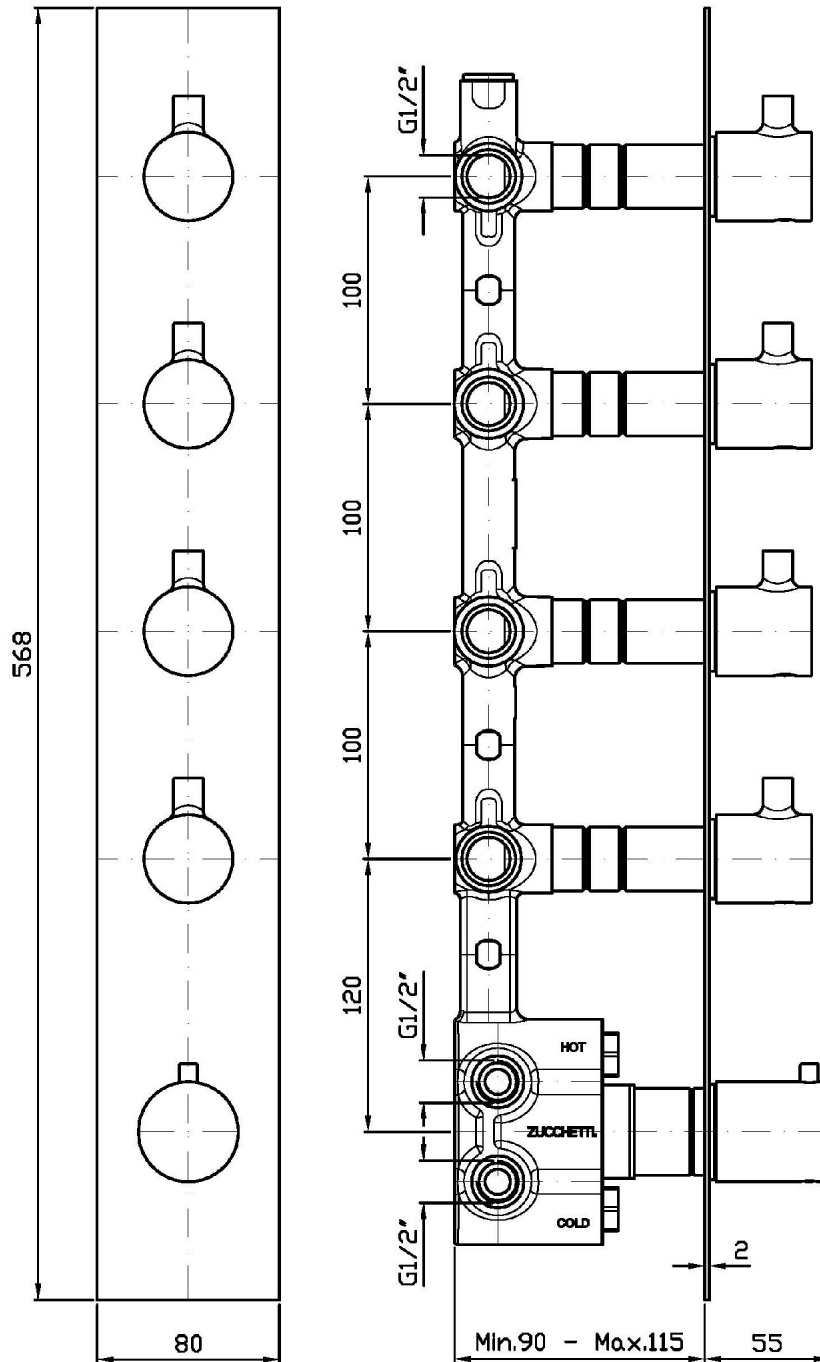

PAN

ZT28662

Esplosi / Exploded

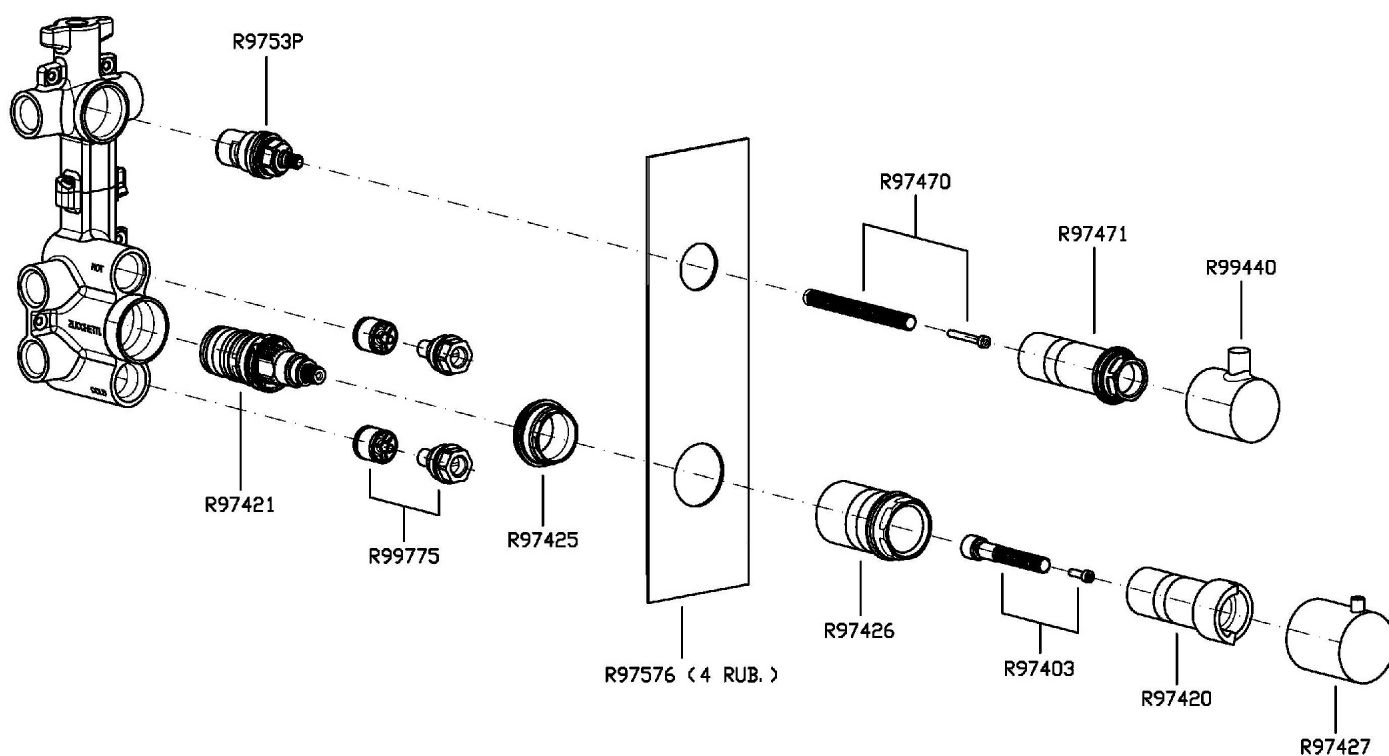

PAN

ZT28662 Portate / Flowrates (lt/min)

PRESSIONE PRESSURE	1 BAR	2 BAR	3 BAR	4 BAR	5 BAR
1 RUBINETTO APERTO <i>P1</i>	13,2	18,4	22,7	26,2	29,2
2 RUBINETTO APERTI 2 TAPS OPENED <i>P2</i>	16,5	23,6	29	33,3	37,6
3 RUBINETTO APERTI 3 TAPS OPENED <i>P3</i>	17,7	25,3	31,3	36,2	40,4
4 RUBINETTO APERTI 4 TAPS OPENED <i>P4</i>	18,5	26	31,9	36,9	41,3
<i>P5</i>					

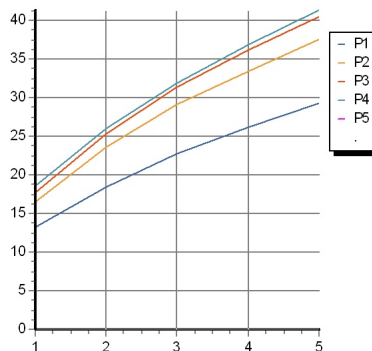

PAN

ZT28662 Pesì e Misure / Weights and Sizes

Peso (Kg) Weight (lb)	3,90 (Kg)	8,60 (lb)
Volume test (dc3) - (in3)	15,13 (dc3)	923,29 (in3)
h (mm) - (in)	140,00 (mm)	5,51 (in)
L1 (mm) - (in)	180,00 (mm)	7,09 (in)
L2 (mm) - (in)	600,00 (mm)	23,62 (in)

