

Features

- Spacious shower base offers ample room for showering.
- Safeguard® slip-resistant surface on bath floor.
- Single threshold for alcove installation with three tile-in flanges.
- KOHLER® enameled cast iron.
- Center drain.

Recommended Products/Accessories

K-9132 Shower Drain
 K-1733 9 kW Steam Generator
 K-702206-G54 Frameless Sliding Shower Door
 K-702206-G73 Frameless Sliding Shower Door
 K-702206-L Frameless Sliding Shower Door
 K-702207-L Frameless Sliding Shower Door
 K-702217-L Frameless Sliding Shower Door
 K-705705-L Frameless Pivot Shower Door
 K-705711-L Frameless Pivot Shower Door
 K-705717-L Frameless Pivot Shower Door
 K-705723-L Frameless Pivot Shower Door
 K-705729-L Frameless Pivot Shower Door
 K-705741-L Frameless Pivot Shower Door
 K-705824-L Semi-Frameless Pivot Shower Door
 K-705825-L Semi-Frameless Pivot Shower Door
 K-706009-D3 Frameless Sliding Shower Door
 K-706009-L Frameless Sliding Shower Door
 K-706012-L Frameless Sliding Shower Door
 K-23726 Drain treatment
 K-23725 Cast iron cleaner



Codes/Standards















ASME A112.19.1/CSA B45.2
 ASTM F462

KOHLER® Enameled Cast Iron Bath and Shower Base Lifetime Limited Warranty

See website for detailed warranty information.

Available Colors/Finishes

Color tiles intended for reference only.

Color	Code	Description
	0	White
	FF	Sea Salt™
	96	Biscuit
	47	Almond
	FD	Cane Sugar™
	NY	Dune
	95	Ice™ Grey
	G9	Sandbar
	33	Mexican Sand™
	K4	Cashmere
	FT	Basalt
	58	Thunder™ Grey
	KA	Black 'n Tan
	7	Black Black™

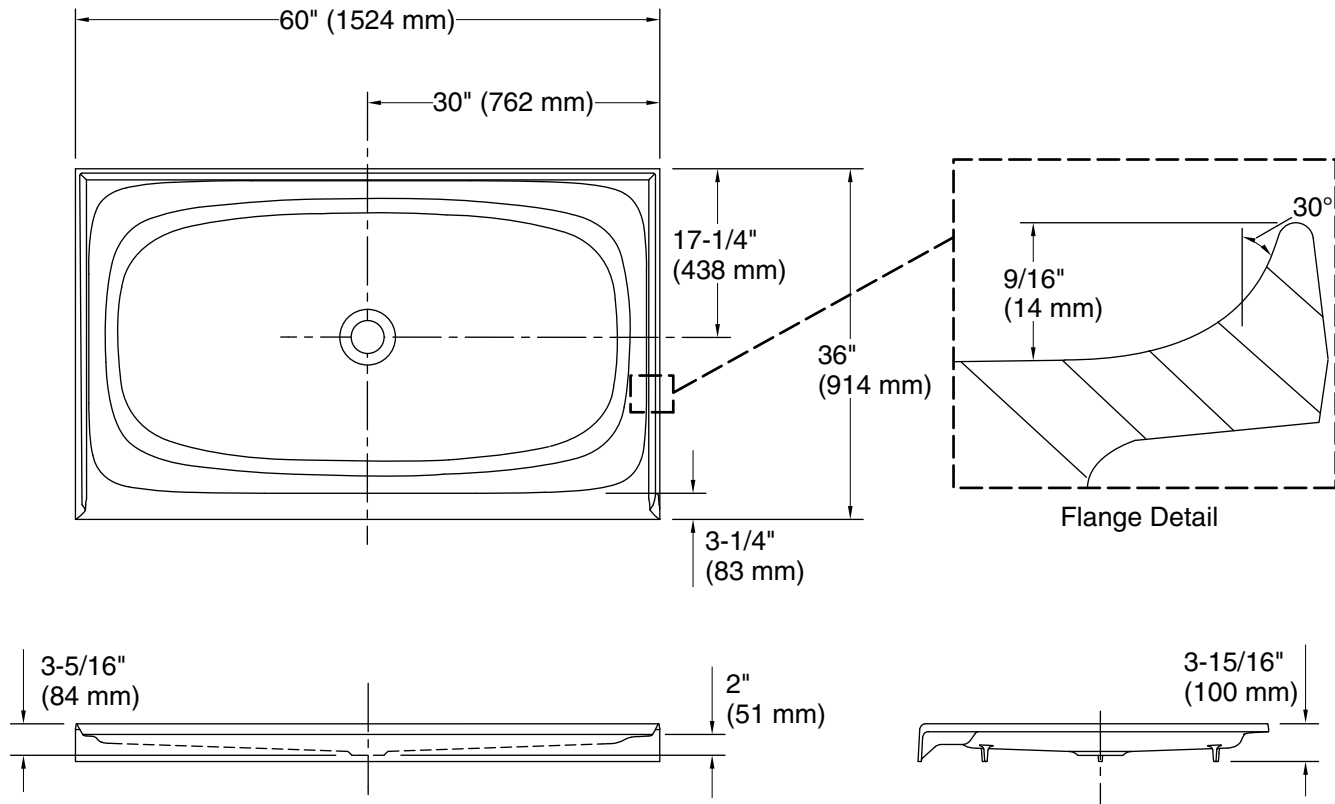

Technical Information

All product dimensions are nominal.

Installation:	Three-wall alcove
Drain location:	Center
Weight:	220 lbs (99.8 kg)
Minimum floor load:	35 lbs/ft ² (170.9 kg/m ²)

Notes

Measure your actual product for rough-in details. Install this product according to the installation instructions.

Shimming may be required to level the fixture.

Shimming may be required between the stud frame and the fixture.

Stud opening tolerance is + 1/4" (6 mm), - 0" (0 mm).

KOHLER steam generator/control kit is designed for use with this product. Kohler Co. shall not be responsible for problems encountered due to the installation and use of other manufacturer's steam generators.