

Collection

HERMES ELLE

Article

HL392_1

Description

Three holes washbasin set with low spout.

Box Dimensions

425x188x98 mm

Weight

2.2 kg

Finishes

- **CC**
CHROME
- **PL**
PLATINUM
- **SS**
BRUSHED
NICKEL
- **ON**
NATURAL
BRASS
- **BO**
MATT
WHITE
- **NP**
MATT
BLACK
- **CF**
BLACK
CHROME
- **CS**
BRUSHED
BLACK
CHROME
- **II**
PALE
GOLD
- **IS**
BRUSHED
PALE GOLD
- **RS**
ROSE
GOLD
- **SR**
BRUSHED
ROSE GOLD
- **OO**
GOLD
- **OS**
BRUSHED
GOLD
- **RR**
ANTIQUÉ
COPPER
- **BB**
ANTIQUÉ
BRONZE



Dimensions

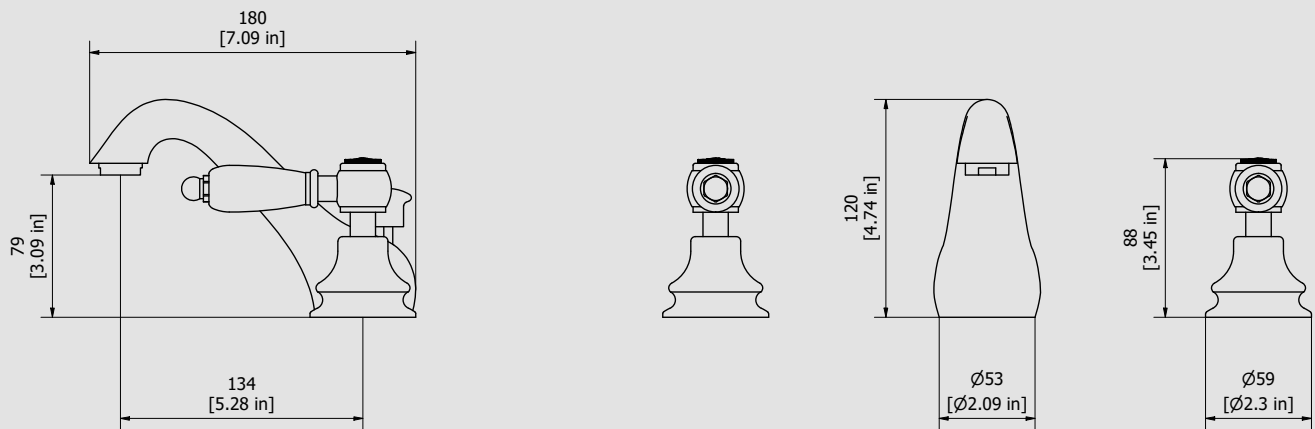

Cartridge

Ceramic headwork

Hoses

Flex inox M10x1 G1/2" L350

Aerator

M24x1

Flow Rate (+/-10%)

1 BAR	2 BAR	3 BAR
9.5 l/m	14 l/m	17 l/m

Production

Main body is a single casted pieces.

Material

BRASS
According to CuZn40Pb3 (CW614N)
Max Lead content: 2.5%



WE ARE IB

Parts list			
ELEM.	CODE	DESCRIPTION	QTÀ
1	AQ0013551	Handle's plug hot	1
2	AQ0009069	Cover Ø20 PLS	2
3	AQ0010985	Inox screw M4x12	2
4	AQ0010229	Inox washer Ø4	2
5	AC0003397	Lever Ø31.5 H42	2
6	AC0004500	Insert for handle	2
7	AT0004520	Rod M8x1 L68.5	2
8	AQ0004525	Grip handle	2
9	AC0004510	Domed nut	2
10	AC0007131	Bell Ø58.5 W26x19 H44.5	2
11	AQ0010096	OR 45.7x2.62 NBR 70 SH	2
12	AQ0009716	Rubber packing 38x30x2	2
13	AS0010697	Washer Ø48 x Ø26.5 x3	2
14	AS0010698	Ring nut W26x19	2
15	AQ0010358	Inox screw M5x16 ISO 7045	4
16	AQ0002135	Ceramic headwork 90° left	1
17	AS0002250	Washbasin upright W26x19	2
18	AQ0015328	Red plug G1/2"	1
19	AS0017088	Spout Ø53 H120 L180	1
20	AQ0000020	Aerator M24 x 1 perlator honeycomb (40200503301)	1
21	AC0017087	Knob Ø25.5 Ø17 H21	1
22	AQ0000920	Flex inox M10x1 G1/2"F L350	2
23	AC0010414	Rod Ø5 H360	1
24	AQ0000280	PUW - PU Joint	1
25	AQ0003140	Pop-up waste 1"1/4	1
26	AQ0015675	Fixing set	1
27	AQ0013552	Handle's plug cold	1
28	AQ0003930	Ceramic headwork 90° right	1
29	AQ0015329	Blue plug G1/2"	1

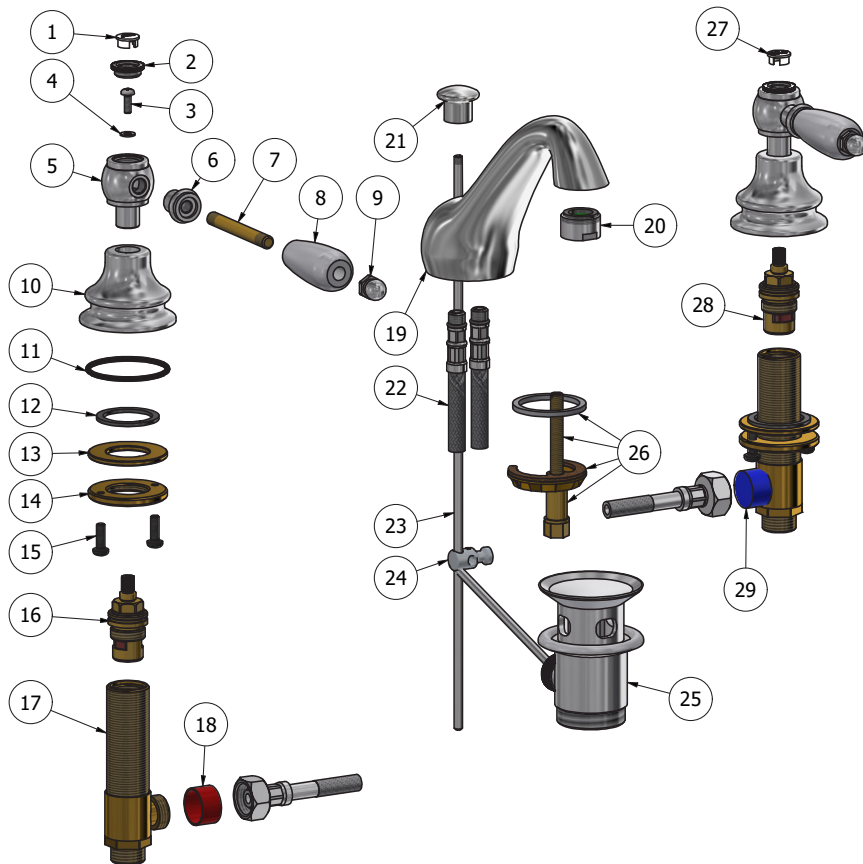



WARRANTY

All IB Rubinetterie SpA products are warranted for 10 years from the date of purchase, for the following cases:

- Defects of casting, porosity and chrome plating.
- Operating defects caused by incorrect fabrication.

The warranty provides for repair or replacement of products with fabrication defects recognized by our technical office. There is no other type of compensation anche the merchandise must be returned FOB our warehouse. The warranty only cover surface defects (scatches, dings, etc.) on fitting that have not been installed and used, returned in its original packaging with all components. O-ring, gasket seals and components subject to wear proportional to use are warranted for 2 years.

The warranty is void in the following cases:

Error installing and putting the product into service.

Deterioration of finished surfaces due to use of cleaning products containing acids or abrasive substances. Deterioration of surface with finishes other than chrome plating. Their durability is, in fact, dependent on the user's care and gentleness of use.

Deterioration of the fitting due incorrect installation.

Improper repairs and maintenance performed without the company's prior authorization.

The warranty from IB Rubinetterie SpA is not renewable.

Cleaning

We recommended cleaning the finish surfaces with water and soap, using a soft cloth.

Do not use detergents that contain hydrochloric acid or abrasive substances.

