

5143800

Finezza UNO Series

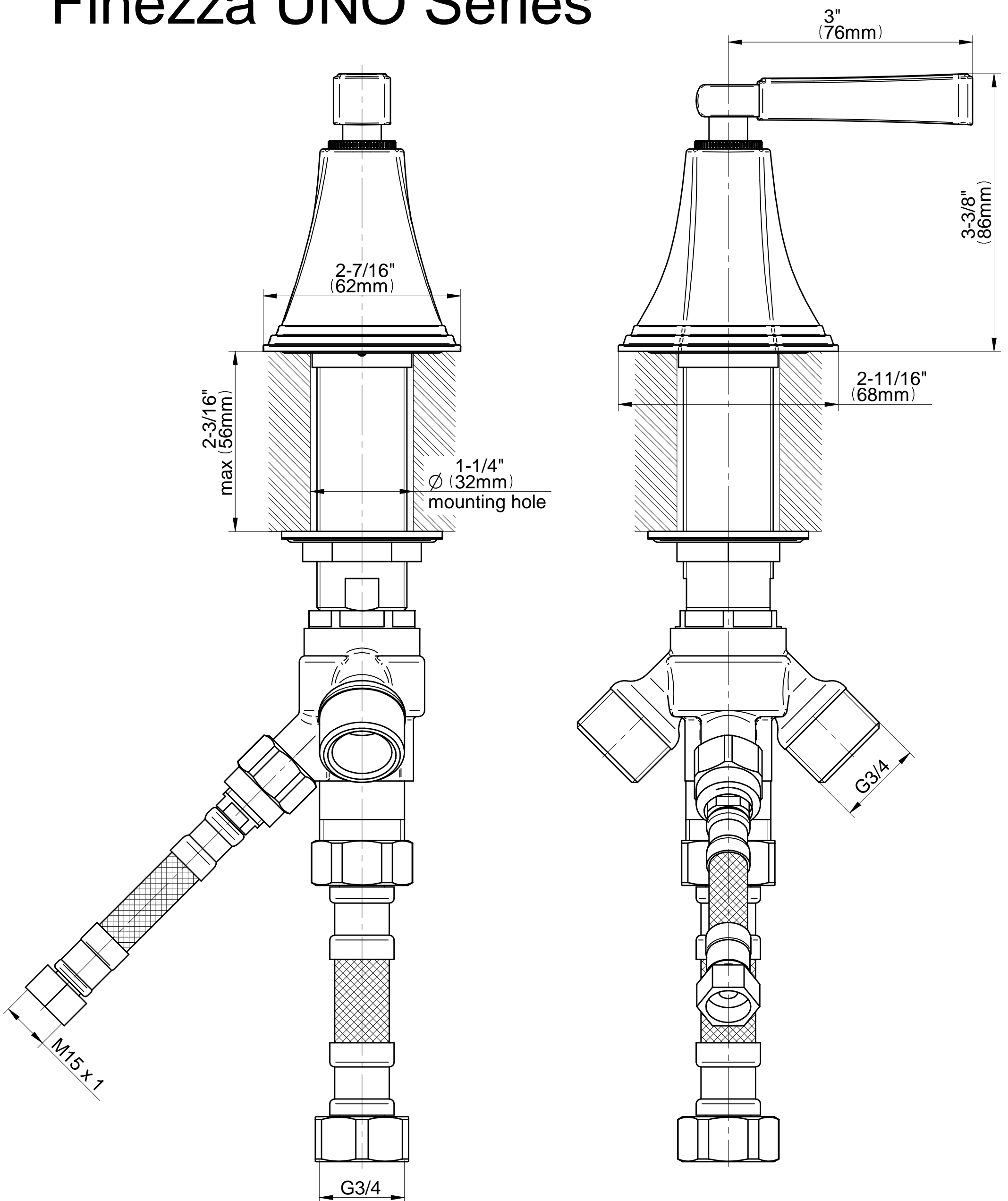

GRAFF[®]
CUTTING EDGE DESIGN