

SET KARTELL BY LAUFEN

Countertop basin, shelf left

81033.5



TECHNICAL DATA

Order no.	81033.5
Certified to	EN 31
Dimensions	600 x 460 mm
Basin capacity	4.8 litre (basin with hidden overflow) 9.7 litre (basin without overflow)
Specification	with special hidden drain Charge 111 – 1 centre tap hole, without overflow
Special specification	Charge 112 – without tap holes, without overflow Charge 158 – 3 tap holes, without overflow Charge 815 – 1 centre tap hole, 1 hole right for mixing unit, without overflow Charge 814 – 1 centre tap hole, 1 hole right for mixing unit, hidden overflow
Weight	15,0 kg
Accessories excl.	Towel frame, order no. 38533.5

Mounting acc. incl.	Valve pre-assembled Charge 111, 112, 158, 815 – valve without overflow always open, order no. 89830.1 Charge 814 – pop up valve, order no. 89830.2
Mounting acc. excl.	Siphon DN 32 chrome, order no. 89394.7 Mounting set M10 x 140 mm, order no. 89988.2
Colours	see colour table

SPECIFICATION TEXT

Countertop basin KARTELL BY LAUFEN, SaphirKeramik
EN 31, dimensions 600 x 460 mm
1 centre tap hole, without overflow, valve without overflow always open
Special feature: with special hidden drain, valve pre-assembled
Further options / accessories: Surface refinement LCC (only white), without tap holes and overflow, 3 tap holes without overflow, 1 centre tap hole with 1 hole right for mixing unit and without overflow, 1 centre tap hole with 1 hole right for mixing unit and hidden overflow, towel frame, bathtubs, shower trays, furniture, accessories
Order no. 81033.5

TECHNICAL DRAWINGS / S 1 : 20

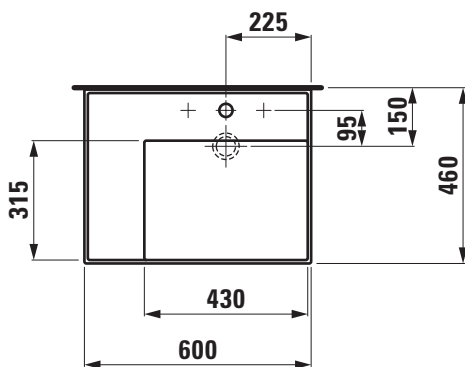

Charge 111, 112, 158, 815

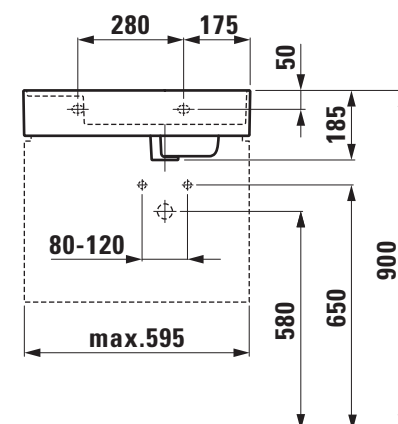
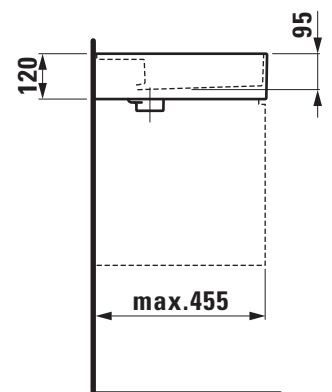
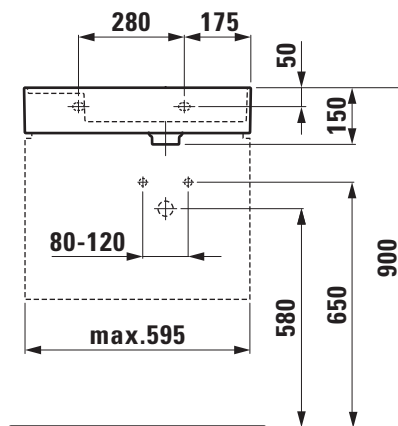

Charge 814

