

Features

- Single-speed whirlpool offers performance and value, with 6 fully adjustable jets.
- Hydromassage flow and direction can be controlled at each jet.
- Built-in heater.
- Generous 6-foot length provides an incredibly spacious bathing area.
- Hourglass shape adds style and elegance to your bathroom.
- Integral flange helps prevent water from seeping behind wall and simplifies alcove installation.
- Textured bottom surface.

Material

- Acrylic.

Hydrotherapy

- Whirlpool.

Installation

- Right drain.
- Alcove.

Recommended Products/Accessories

K-1283 Removable Apron
K-1491 Bath/Whirlpool Pillow
K-24916 Wireless Music Kit
K-23726 Drain treatment
K-23732 Tub & shower cleaner
K-37380 30" Rough-in Cable Bath Drain
K-37383 Rough-in cable bath drain, PVC, 30" cable with tubing
K-7265 Clearflo Bath Drain
K-37386 rough-in cable drain, PVC, 30" cable



Codes/Standards

ASME A112.19.7/CSA B45.10
CSA B45.5/IAPMO Z124
ASTM E162
ASTM E662
UL 1795





**KOHLER® Plastic Baths and Receptors
Lifetime Limited Warranty
KOHLER® Hydrotherapy Components
Five-Year Limited Warranty**

See website for detailed warranty information.

Available Colors/Finishes

Color tiles intended for reference only.

| Color | Code | Description |
|-------|------|-------------|
|-------|------|-------------|

| | | |
|--|----|---------|
|  | 0 | White |
|  | 96 | Biscuit |
|  | 47 | Almond |
|  | NY | Dune |
|  | G9 | Sandbar |

No change in measurements if connected with drain illustrated. (K-11677)

 Recommended Faucet Location

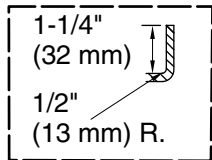

Integral Flange Detail

Pump/Control Access (If Apron Is Not Used):
20" (508 mm) W x 15" (381 mm) H

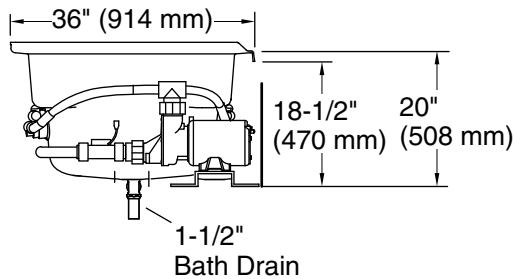

Pump/Control Access
(If Apron Is Not Used)
20" (508 mm) W x 15" (381 mm) H

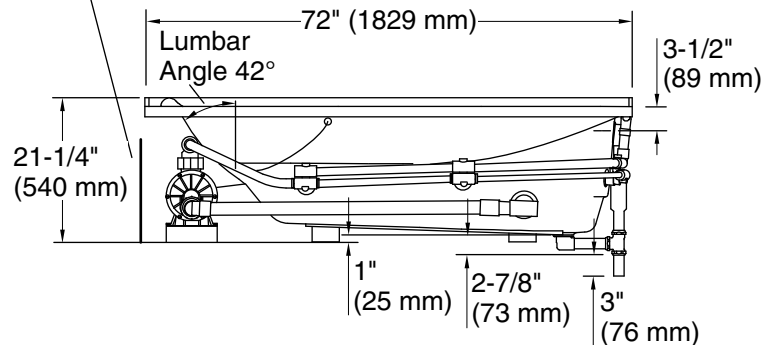
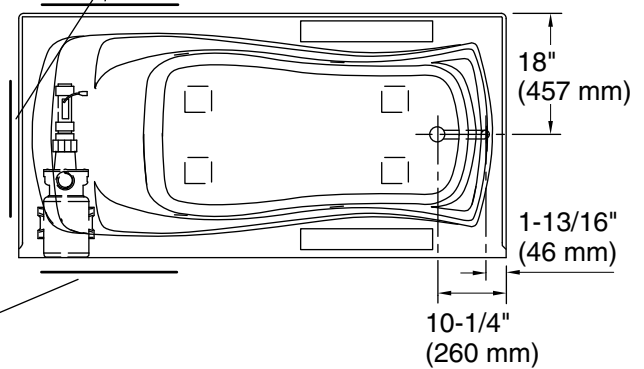

Required Electrical Service

Two dedicated circuits required, protected with Class A Ground-Fault Circuit-Interrupter (GFCI). Outside North America, this device may be known as a Residual Current Device (RCD).

Pump: 120 V, 15 A, 60 Hz
Heater: 120 V, 15 A, 60 Hz

Technical Information

All product dimensions are nominal.

Installation: Three-wall alcove
Drain location: Right
Basin area, bottom: 50" x 24" (1270 mm x 610 mm)
Basin area, top: 65" x 27" (1651 mm x 686 mm)
Weight: 115 lbs (52.2 kg)
Minimum floor load: 41 lbs/ft² (200.2 kg/m²)
Water depth: 14" (356 mm)
Water capacity: 72 gal (272.5 L)
Electrical component rating: Pump: 120 V, 7.5 A, 60 Hz
Heater: 120 V, 12.5 A, 60 Hz, 1500 W
Pump speed: Single
Minimum flat for door: 2-1/8" (54 mm)

Notes

Measure your actual product for rough-in details. Install this product according to the installation instructions.

The hot water supply should be 70% of the capacity of the bath or greater. Installations will vary.

If installing a rim-mount faucet, make sure there is no interference above or below the deck before drilling any holes.