

# MF - 311

Писсуар подвесной

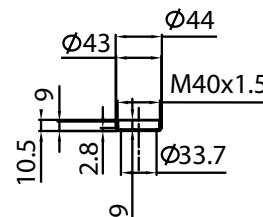
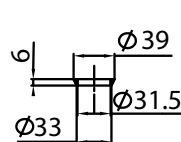
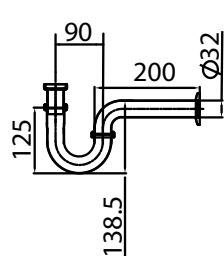
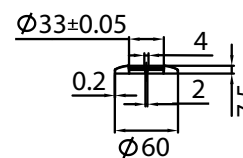
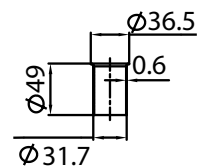
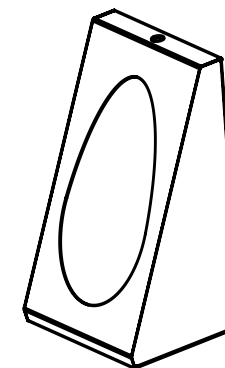
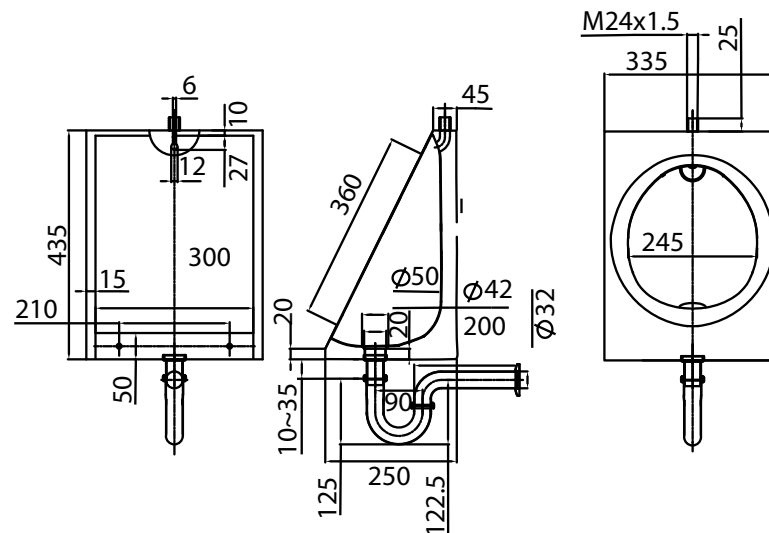

### Технические данные

Ш x Д x В	250x335x435 мм
Установка	Подвесной
Толщина	1,2-2,5 мм
Вес	6 кг
Марка стали	AISI 304

**MOEFF**

НЕРЖАВЕЮЩИЕ РЕШЕНИЯ

