

Le Giare - art. LGLA60

lavabo da appoggio
on-top washbasin

cielo
handmade in Italy



PESO NETTO/NET WEIGHT: 10,85 Kg

PCS PALLET: 20
PCS PALLET CONTAINER: 40

ACCESSORI/ACCESSORIES:

PIL01 - Piletta universale click-clack CROMO con coperchio in ceramica / Universal click-clak drain in CHROME with ceramic lid

PIL01NM - Piletta universale click-clack NERO MATT con coperchio in ceramica / Universal click-clak drain in MATT BLACK with ceramic lid

PIL01BR - Piletta universale click-clack BRONZO con coperchio in ceramica / Universal click-clak drain in BRONZE with ceramic lid

PIL01CM - Piletta universale click-clack CEMENTO con coperchio in ceramica / Universal click-clak drain in CEMENTO with ceramic lid

SISP - Sifone CROMO / CHROME siphon



SIFN - Sifone NERO MATT / MATT BLACK siphon

SIFBR - Sifone BRONZO / BRONZE siphon

SIFCM - Sifone CEMENTO / CEMENTO siphon

FINITURE





FINISHES

-  Bianco/white - glossy
-  Nero/black - glossy

Le Terre di Cielo

-  Talco
-  Pomice
-  Brina
-  Basalto
-  Lavagna
-  Cemento
-  Fango
-  Cacao
-  Arenaria
-  Avena
-  Lino
-  Agave
-  Muschio
-  Polvere
-  Cipria
-  Canapa

Le Pietre

-  Carrara Statuario
-  Breccia Arabescata
-  Grey Stone
-  Breccia Paradiso
-  Nero Marquina

 
DoP No. 14688.01

Ottobre 2020

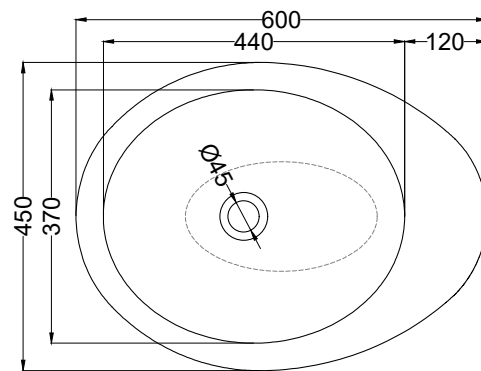

TOP

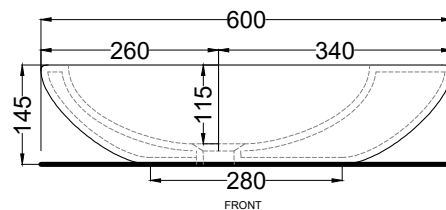

FRONT

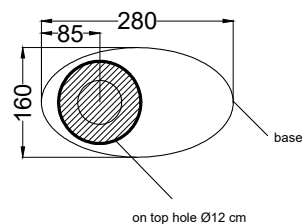

on top hole Ø12 cm

ATTENZIONE:
Superfici, pesi e misure riportate possono presentare leggere differenze rispetto ai pezzi reali, in considerazione e accordo delle caratteristiche di tolleranza intrinseche del materiale ceramico e del suo processo produttivo. L'azienda si riserva di cambiare schede tecniche e caratteristiche di funzionamento degli articoli in ogni momento e senza necessità di preavviso.

ATTENTION:
Surfaces, weights and dimensions can show some little differences compared to the real item, following typical intrinsic characteristics of ceramics material and production. The company reserves the right to change any technical specifications/ dimension and/or operating characteristics of the products at any time and without giving notice.