

DANIEL
RUBINETTERIE

MILANO

SCHEDA TECNICA TECHNICAL FEATURES

ART. COD.

OM700D2P

G 1/2" INGRESSO ACQUA FREDDA
G 1/2" COLD WATER INLET

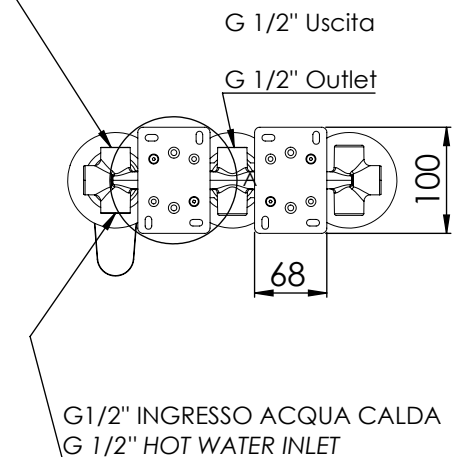

G 1/2" INGRESSO ACQUA CALDA
G 1/2" HOT WATER INLET

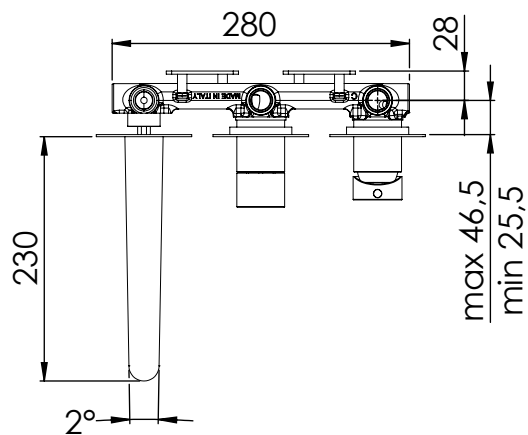
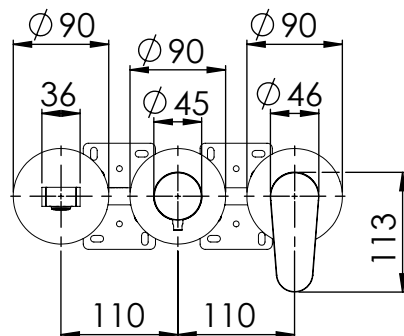
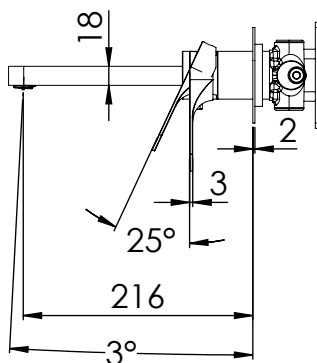
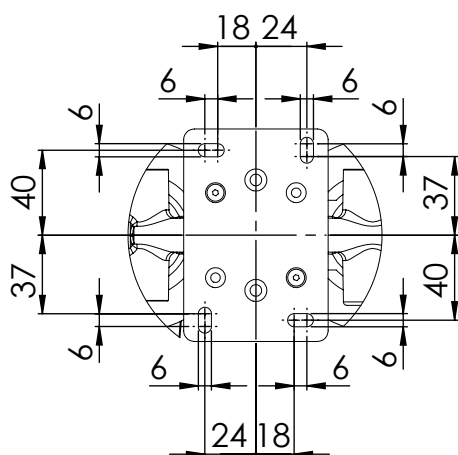

MATERIALI / MATERIALS

OTTONE CROMATO / CHROME PLATED BRASS

CROMATURA / CHROME PLATING

UNI EN 248

Via Leonardo da Vinci 53 20062 Cassano d'Adda (MI) Italy Tel. +39-0363 62651
info@daniel.it www.daniel.it