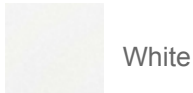
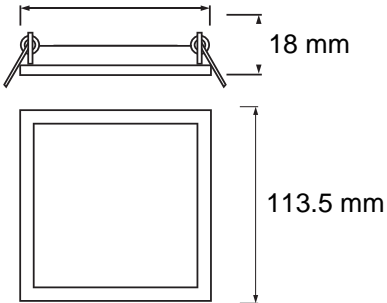

# LED PANEL

 Product&Family Code: **056 005 0006**
**SLIM / Sq-6**

## Technical Drawing

 **105x105**

## Photometric Diagram

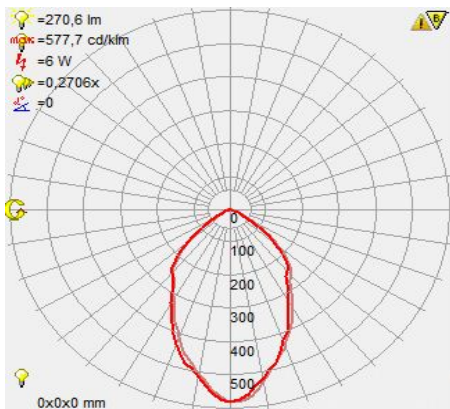

## Technical Data

Voltage (V)	220-240V
Product Wattage (W)	6
Equivalence with incandescent lamp(W)	48
Colour Render Index (Ra)	>Ra70
Colour Temperature (K)	2700K / 4200K / 6400K
Materials	Aluminium
Protection Class	II
Dimmable	No
EEI	<b>A</b> to <b>A++</b>
Warm-up time up to 60 %of the full light output	Instant Full Light
Luminous Flux (lm)	270
Luminous Efficacy (lm/W)	45
Rated Life (hrs) ⌚	50.000
IP Rating	20
Power Factor	>0.5
Beam Angle	120°
Starting Time	<0.2s
Number of ON-OFF cycling	x25.000

## Applications

- Office Lighting, Meeting Rooms, Restaurants, Hospitals, all indoor applications.



## Features

- High Lumen and CRI, Good quality & Constant Current driver.
- High heat dissipation, low carbon and environmental protection.
- SMD LED Lamp Base.
- Very low energy consumption.

