









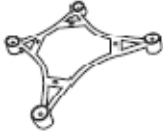

C631

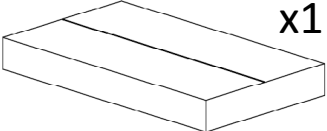

 x1	 15 min	 Ax2	 Cx1	 M6X14 Ex4	 Gx4	 Ix1
 x1		 Bx2	 M8X25 Dx4	 Fx4	 Hx1	

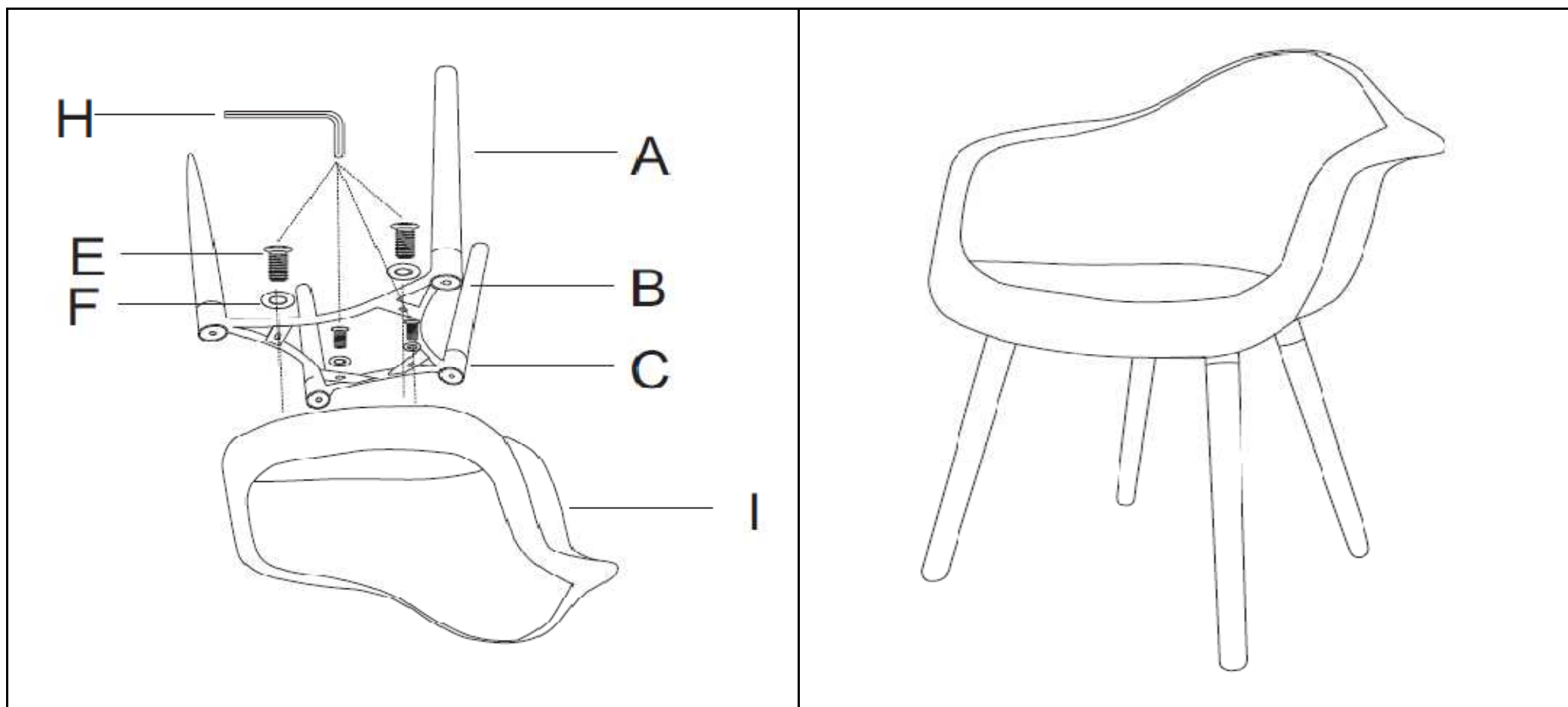

C631

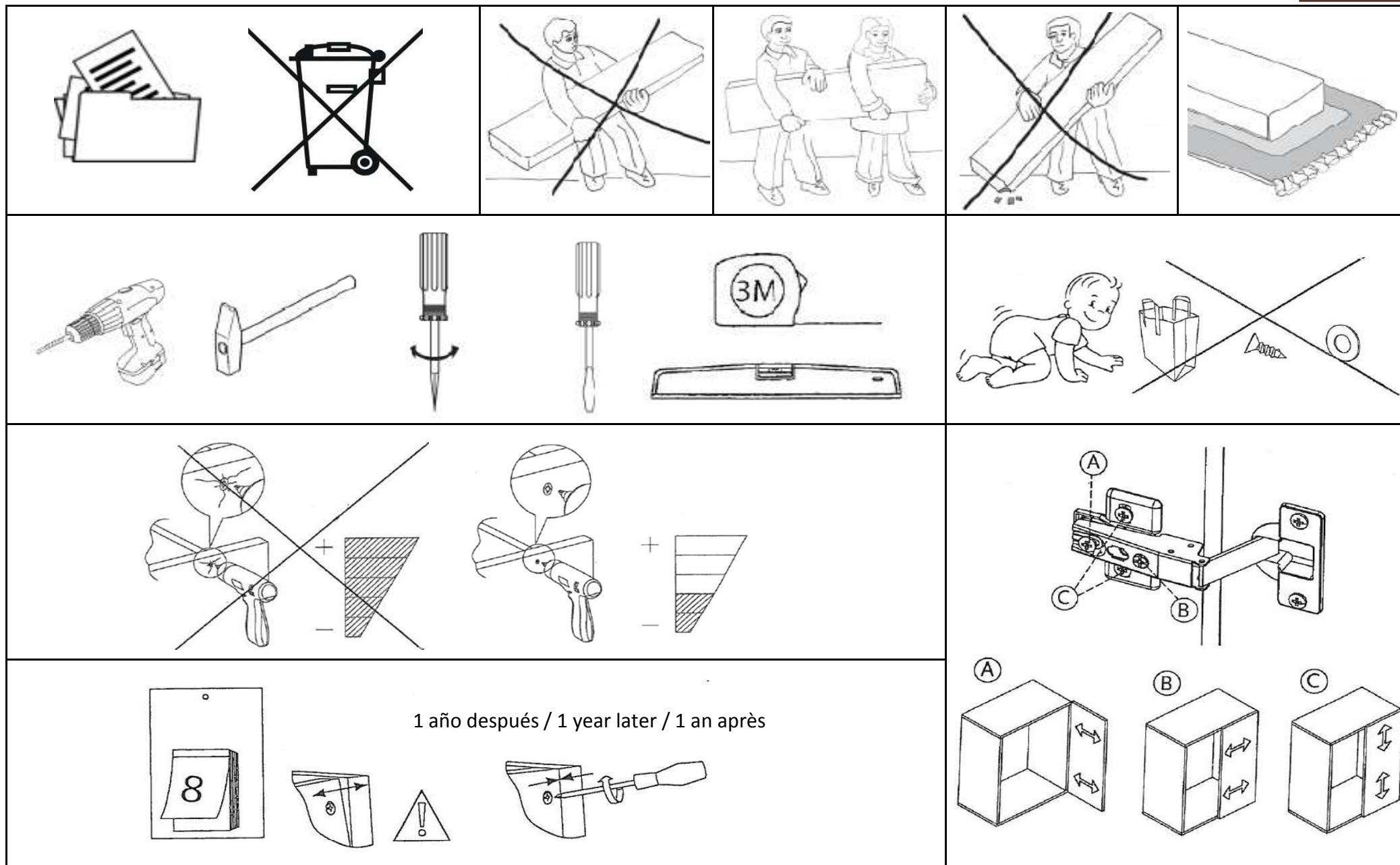

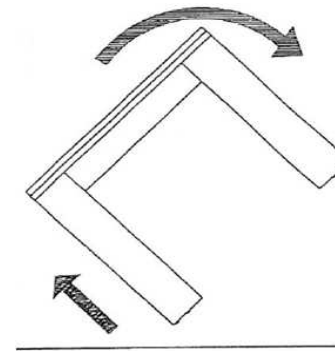
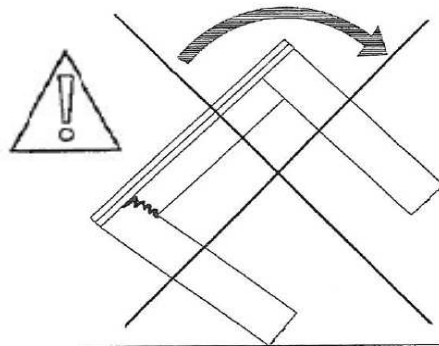
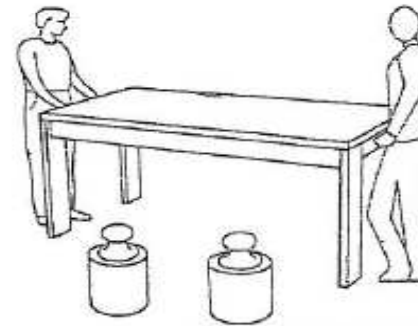
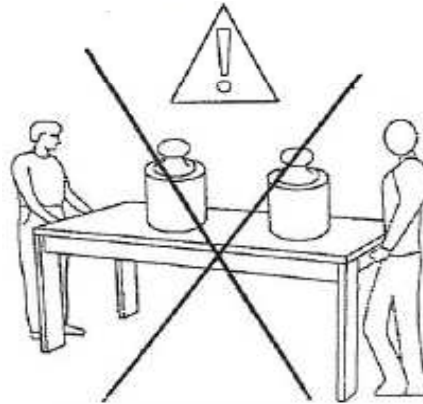
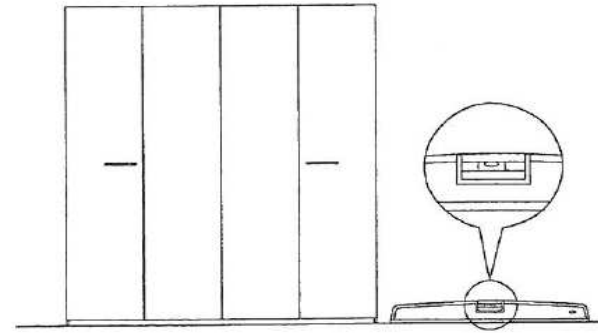
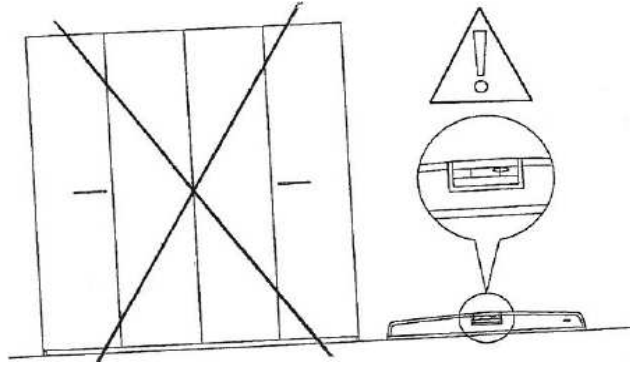

C631

