

femira





Boxspring bed with headboard Nature II



Boxspring bed with headboard Nature I



Detail headboard Nature I



Detail headboard Nature III



Boxspring bed with headboard Nature III and bedspread

A Systematic Good Night Sleep:

There are countless criteria for restful nights. One, being **aesthetics**. That is why we made it our mission to provide the groundwork for a healthy sleep, without compromising a stunning appearance. With **Couture 4.0** you get to choose between a comfortable boxspring bed and an upholstered bed of equal quality which sports an intelligent storage function. Compose your own, personal feel-good Oasis out of diverse Headboard designs, a new world of colours as well as new structures and materials.



Boxspring bed with headboard Nature III

Couture 4.0 - You get to choose

Boxspring bed or upholstered bed

The structure of the Boxspring bed differs from the upholstered bed as shown below and to the right. With the help of the following pages and the assigned symbols for orientation, you can arrange your individual bed with ease.

The build makes the difference - you get to choose!

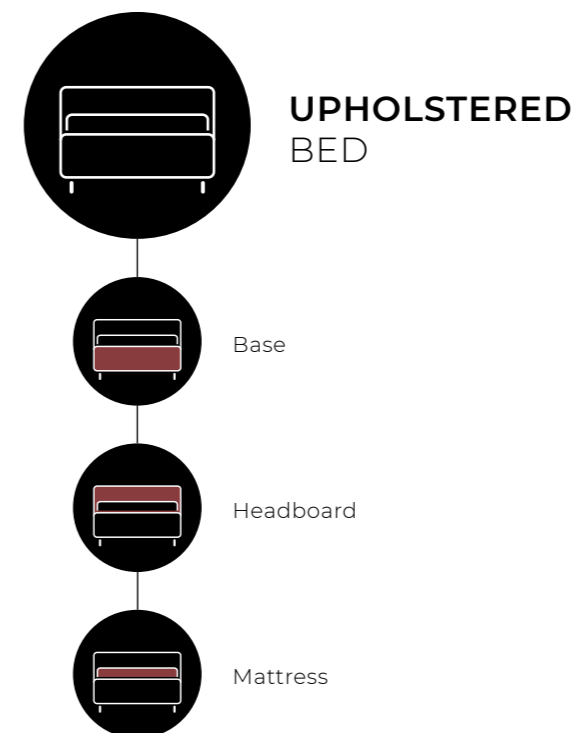
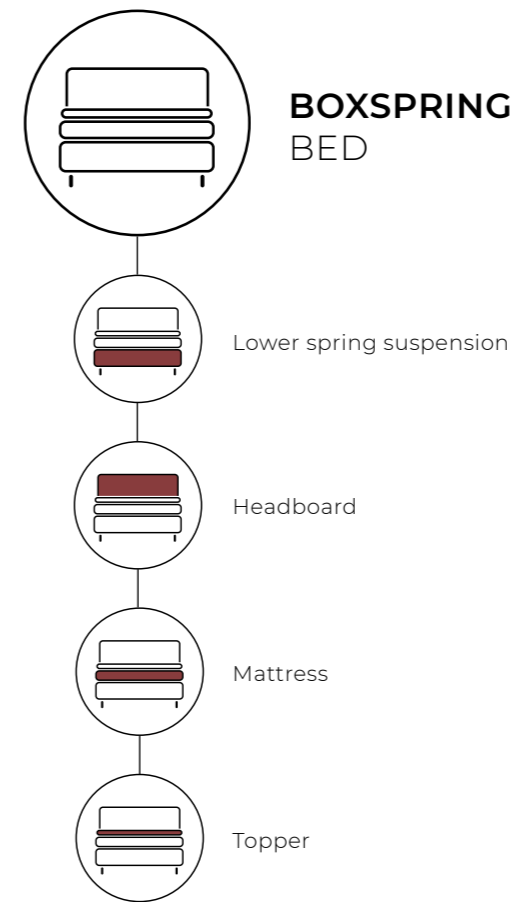

Detail boxspring bed with headboard Chianti



Detail boxspring bed with headboard Tosca





Detail boxspring bed motor-driven

Lower spring suspension

for boxspring bed

Ergonomic lower spring suspension to please even the most sensitive: The boxspring bed's lower suspension is comprised of a sturdy wooden structure with integrated spring core technology.



BO fix
Bonnell spring core
35 cm high
15 cm clearance



T fix / mot
pocket spring core
35 cm high
15 cm clearance



KTR30 fix / mot
pocket spring core
30 cm high
15 cm clearance



KTR35 fix / mot
pocket spring core
35 cm high
9 cm clearance



Substructure

for upholstered bed

The upholstered bed augments modern sleeping-culture by a perfekt storage technology. Thanks to the use of high-quality gas pressure springs, the aired bed frame's operability is enhanced. With a volume of about 260 l (at 180 x 200 cm) the bed frame leaves space for a bedspread, pillows and more. Spring wood frames of four variations allow first-class comfort - tailored to specific requirements.

Upholstered bed with manual adjustability



Upholstered bed with motor-driven adjustability



Detail bed base opening



From upholstered to boxspring on request!

Revolutionary! Boxspring inside

...is a sturdy lower structure with micro-compartment spring cores in conjunction with a put on mattress. Because of the high spring deflection, this system provides maximum comfort.



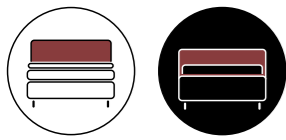

Headboard

for boxspring and upholstered bed

Delicate, fine, voluminous or classic - with **Couture 4.0** wishes do come true. A manifold selection of headboards transforms the boxspring or upholstered bed into an individually styled designer object.



- Edition Ergo -

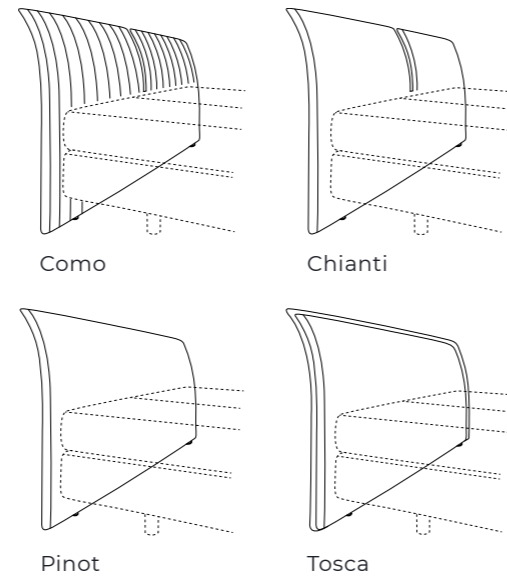

- Edition Toronto -

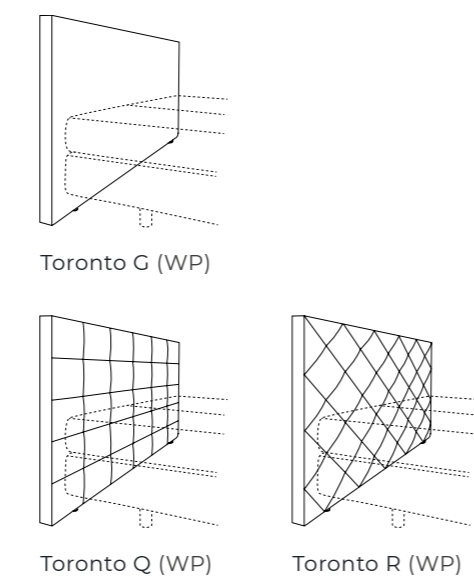

- Further headboard varieties -

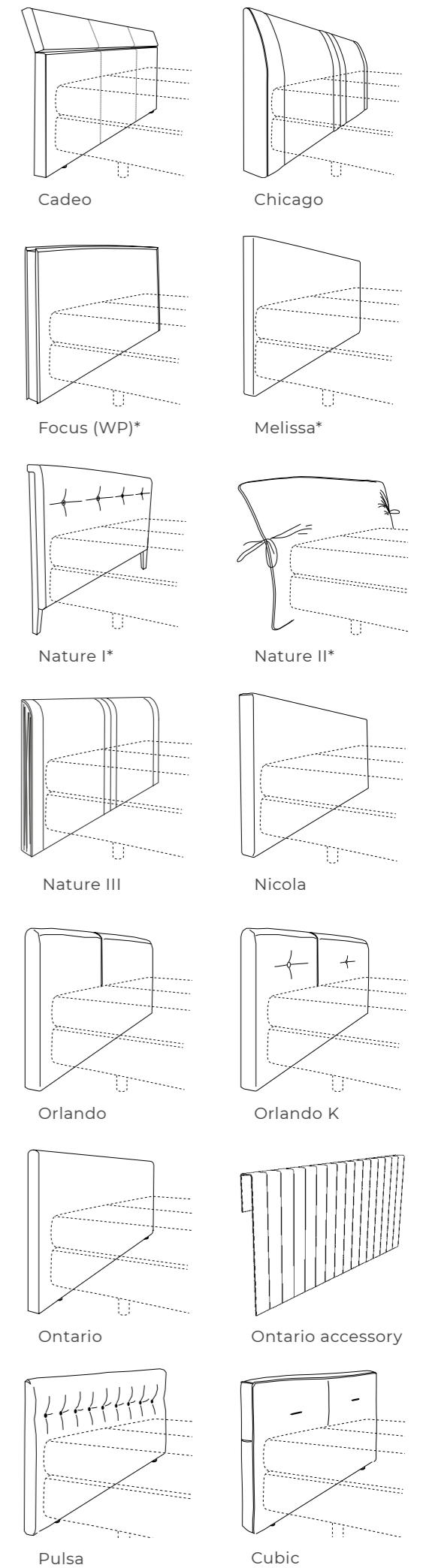

WP = wall panel | *Headboards Focus, Melissa, Nature I, Nature II are only available with boxspring beds.



Detail Twin-Spring-Technology



Sprung mattress

for boxspring and upholstered bed

The **Couture 4.0** mattress range bundles the essential variants into a more condensed selection. The pocket sprung mattresses shown below are each available with either stretch covers or upholstery fabric covers. They also are compatible with both boxspring and upholstered beds.

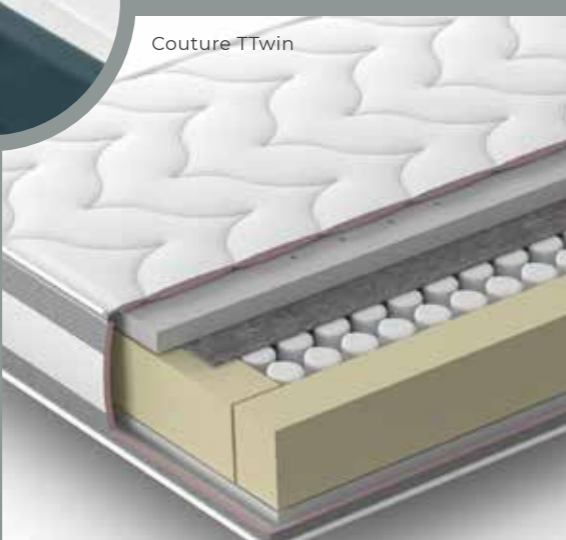
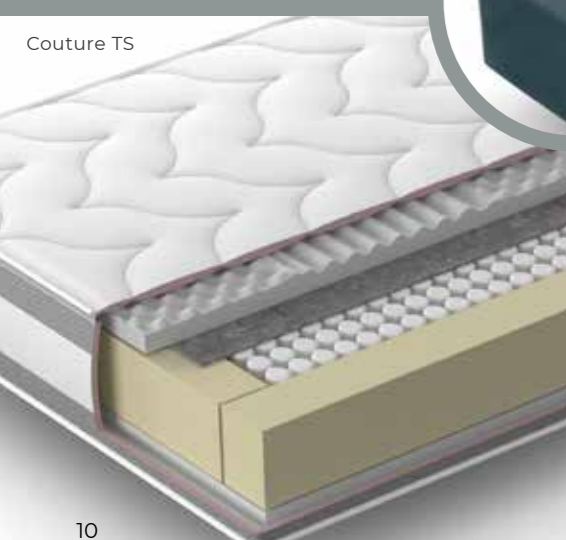
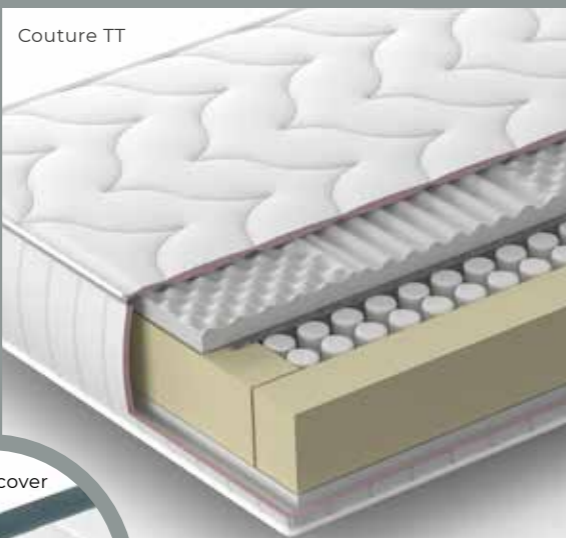
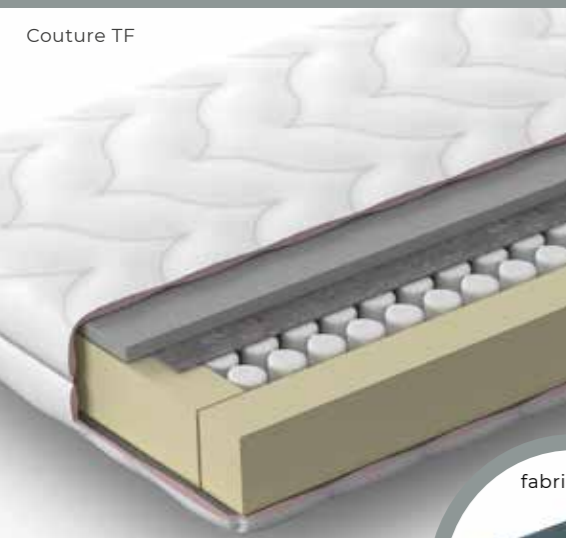

Pocket sprung mattresses

- Couture TF**
ca. 300 springs/2m², height 18cm, core 16cm
- Couture TT**
ca. 435 springs/2m², height 23cm, core 20cm
- Couture TS**
ca. 1000 springs/2m², height 23cm, core 20cm
- Couture TTwin**
ca. 435 springs/2m² with Twin-Spring-Technology, height 22cm, core 21cm

All spring mattresses are available with fabric- and stretch cover!

Mattress sizes: 80-90-100-120-140-160 x 200cm, on request also in 220 cm special length.

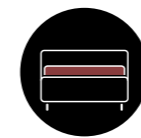

Couture KS1

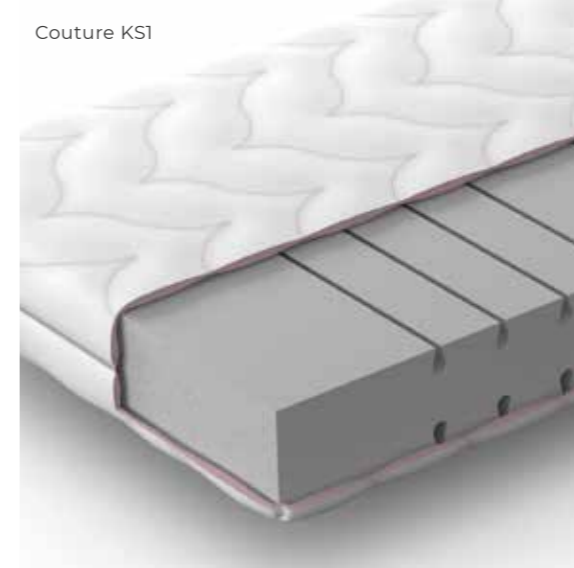

Couture KS2

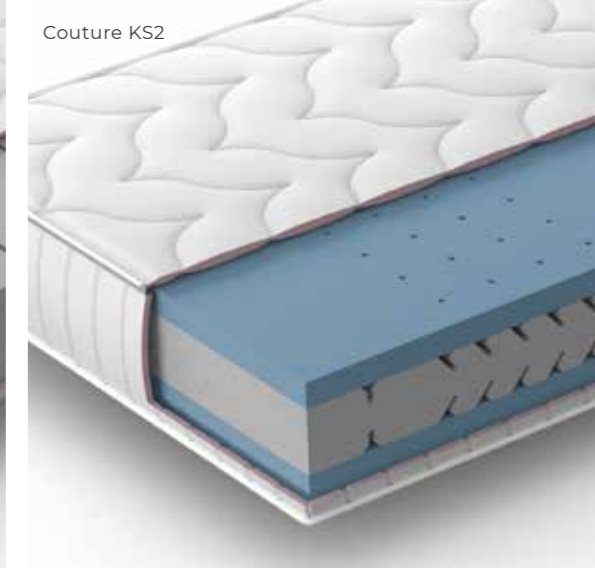

Couture KS3

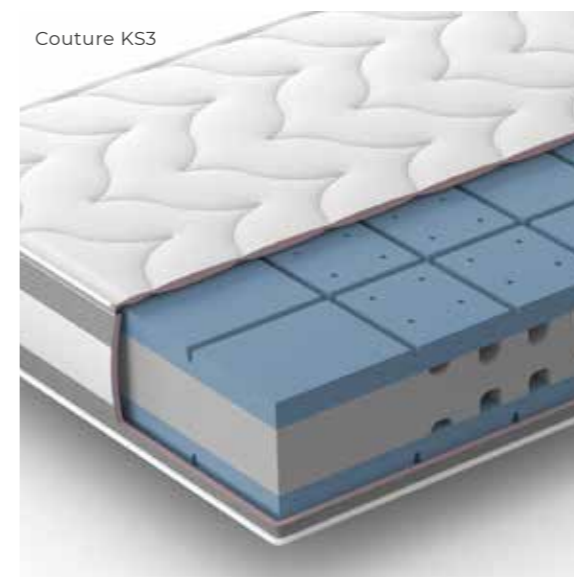

Cold-foam mattresses

- Couture KS1**
2D-Cut-Coldfoam-core, height 18cm, core 16cm
- Couture KS2**
3-Layer-Coldfoam-core, height 21cm, core 18cm
- Couture KS3**
3-Layer-Coldfoam-core, height 21cm, core 18cm

All Cold-foam mattresses are available with fabric- and stretch cover!

Mattress sizes: 80-90-100-120-140-160 x 200cm, on request also in 220 cm special length.

Cold-foam mattress

for upholstered beds

The **Couture 4.0** cold-foam mattresses are exclusively available for upholstered beds. No matter which way you decide, in either case you will receive a highly comfortable mattress made from long lasting, quality foam.



Topper

for boxspring bed

The cherry on top of your boxspring bed sundae. Depending on your sleep characteristics, **Couture 4.0** offers toppers in various foam-qualities, all wrapped in a sophisticatedly crafted stretch cover.



- Standard topper**
the standard topper is available with a cold-foam- or visko core, height 6cm, core 4cm.
- Luxury topper GL**
gelax topper with laterally integrated climate strip in cover, height 8cm, core 6cm.
- Luxury topper HS**
hypersoft cold-foam topper with laterally integrated climate strip in cover, height 8cm, core 6cm.



Couture TT with Topper HS or GL



Couture TS mit Topper HS oder GL



COUTURE 4.0 - CONNECT

the intelligent mattress- and topper connection

top innovation, top lying comfort: To ensure a fast and uncomplicated connection between mattress and topper, the new Couture Connect mattresses are fitted with zippers on top and bottom - both neatly hidden behind the border edge. This way, unrestricted flipping of the mattress is possible. Please make sure to always connect the topper to the upper side.

Couture TT with Topper HS or GL

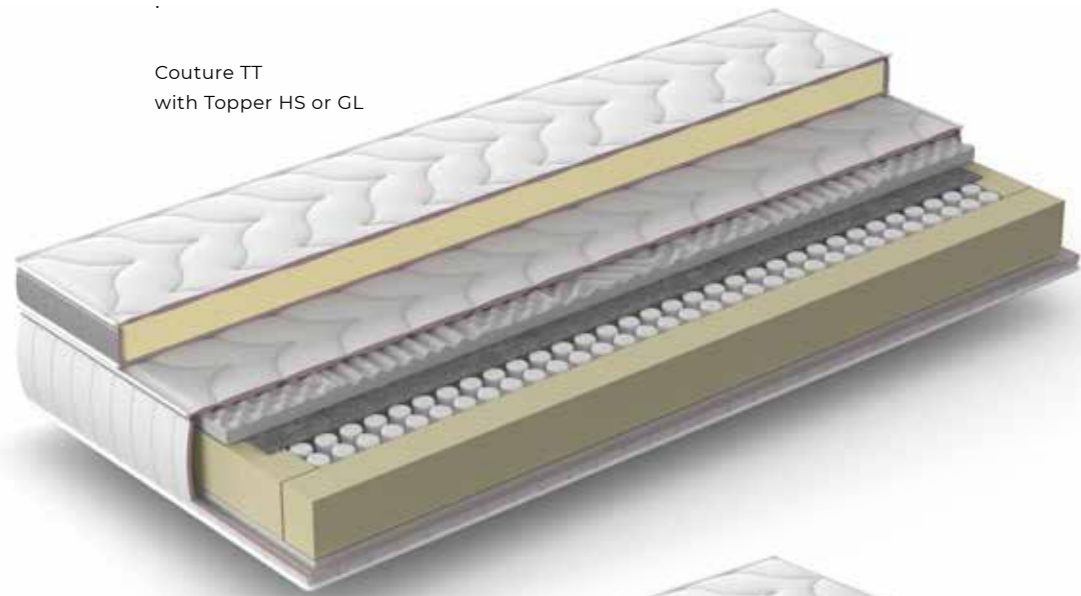

Couture TS with Topper HS or GL

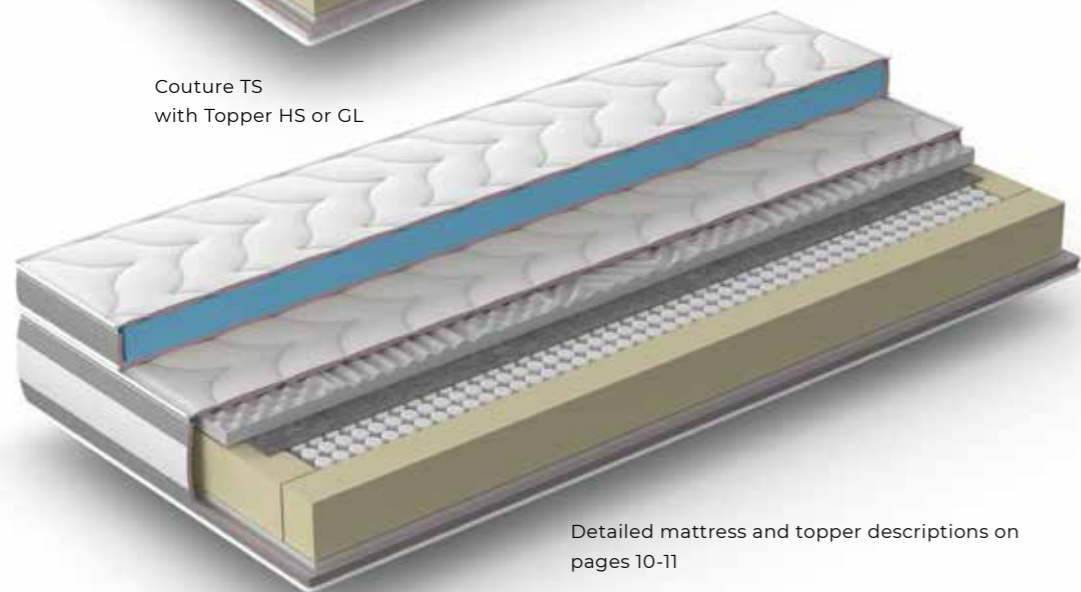

Detailed mattress and topper descriptions on pages 10-11

Together a perfect unit

Both pocket sprung mattresses, Couture TS and Couture TT can each be connected with the Topper HS (cold-foam/hypersoft foam) or GL (gelax special foam). Considering which sleep type is yours, choose one of the four variants.

Couture Connect: pocket sprung mattress with topper connection
Detailed mattress and topper descriptions on pages 10-11



Couture TT with HS



Couture TS with HS



Couture TT with GL



Couture TS with GL



Upholstered bed with headboard Cadeo



Boxspring bed with headboard Cadeo



Detail headboard Cadeo



Detail 3-sided velcro cover for lower suspension



Boxspring bed with Headboard Orlando

Decorative legs upholstered bed



Decorative legs boxspring bed



Standard legs boxspring bed



A leg to stand on

Floating optics or design-highlight?
Choose from these or many more alternatives for bed legs!

Boxspring bed with headboard Toronto R





Traditional manufacture
Seit 1801
restful nights for



Quality is never an accident

For more than 200 years now, the company femira stands for for the crafting of high quality upholstery.

The focus on the field of bed-systems has established a great level of competence within the market today. With a healthy mix of manual labour and automated handling, femira set a goal at a lot-size 1 production in the 4.0 industry. A goal which ensures a steady expansion of the manufacturing site. Due to highest standards of quality and specially trained employees, their products are coming into being within the shortest amount of time, made in Germany.

The stylistically confident collection of fabrics appeals mostly thanks to the sophisticated quality of the JAB Anstoetz - one of the world's largest textile houses.

1801

FAMILY GUSSMANN

Founding of the saddlery and upholster's workshop in Pleidelsheim. The business is a family ownership of 6 generations.

1911

femira's story of success begins. Gottlob Gussman takes over his fathers workshop in the fourth generation. 1937 the ground stone for industrial manufacturing is being laid, in order to combat the rising demand for Gussmann's protective covers.

1990

The femira facilities become part of the Merkur Holding AG (today Valora)

2000

Continuation under new company name "Wellform"

2004

Part of „Hüls-Gruppe“ und moving of production to Herzebrock-Clarholz in East-Westphalia.

2018

FAMILY WIEMANN

Investment for made in Germany

Family Wiemann takes over the company „femira Bettensysteme GmbH & Co. KG. With Wiemann as head of the company, femira could welcome a bedroom-specialist with excellent connections to the national and international market.

The past is history



Traditional manufacture
since
1801
for restful
nights



boxspring bed with headboard Toronto R



Illustration on front page: upholstered bed with headboard Orlando

ORIGINAL DGM BOXSPRING

Boxspringbett / boxspringbed
Hersteller-Nr. / manufacturer-no.
B17-103
Kollektion / collection / Modell / model
Kollektion 2017/2018
Prüfnummer / control number
17-103-01



Geprüft und zertifiziert nach den Anforderungen der RAL-GZ 430 der Deutschen Gütegemeinschaft Möbel • Tested and certified according to the requirements of RAL-GZ 430 of DGM • www.dgm-boxspring.de



femira

femira Bettensysteme GmbH & Co. KG | Daimlerstraße 2 - 4 | DE - 33442 Herzebrock-Clarholz | info@femira.de | www.femira.de

In cooperation with bedroom furniture manufacturer **Loddenkemper**