

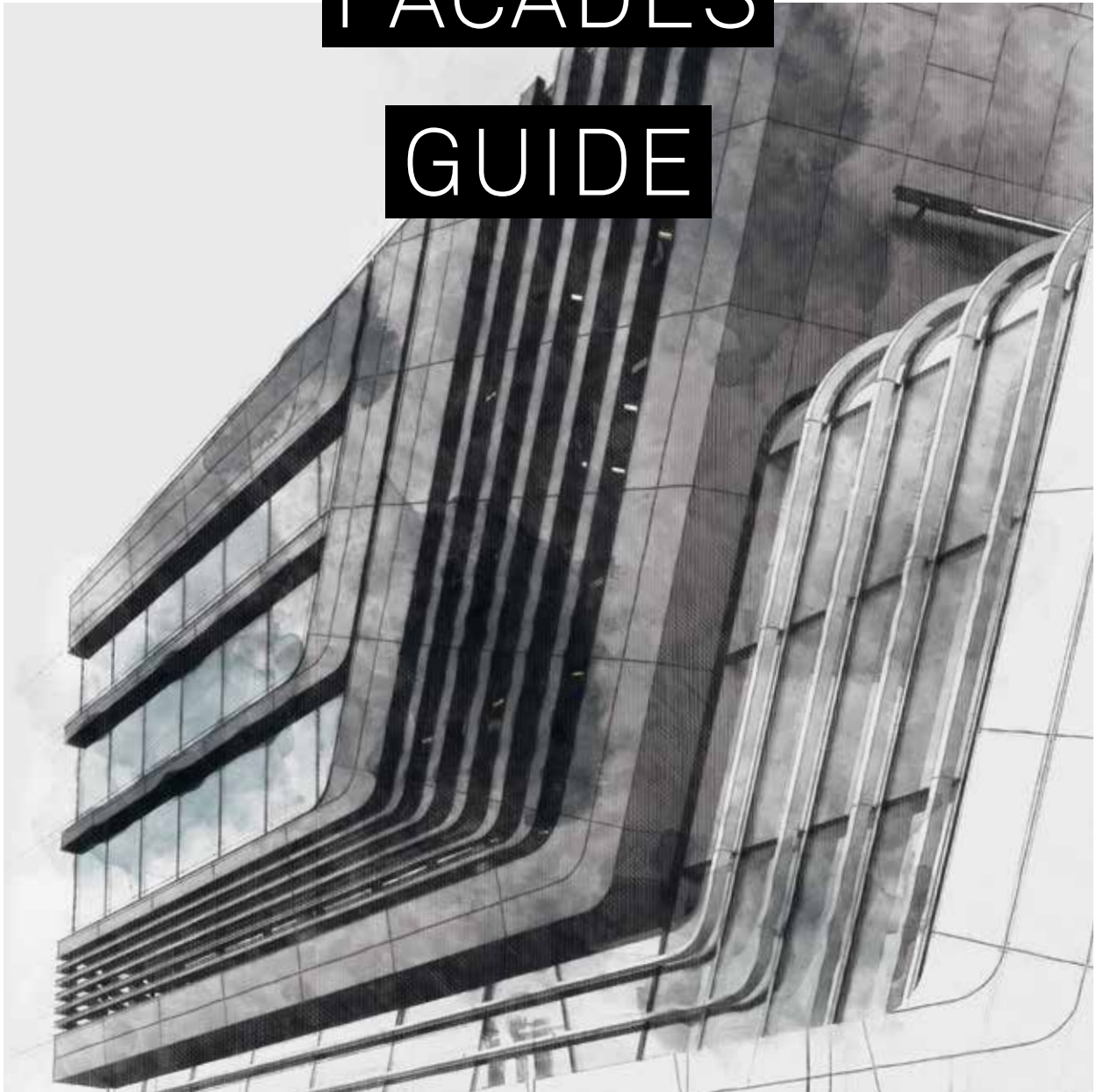

RIEDER

FACADES

GUIDE



Edition #20plus

Material | Design | Building

STAY AWAY FROM LONELY PLACES

Wolfgang Rieder founded his company with fibreC in 2004. His vision was to create a light yet stable facade panel with glassfibre reinforced concrete that can withstand weather and environmental influences, while being both sustainable and aesthetically pleasing.

Over the past 16 years, Rieder's product range has grown and so has the architectural design possibilities of the material. There is one topic that drives Wolfgang Rieder and which he engages with self-critically and with ambition: the decarbonisation of the company.

Innovation out of a sense of responsibility

An interview with Wolfgang Rieder

What do more than 50,000 trees have to do with Rieder?

A lot! We calculated the company's CO₂ footprint, which amounts to 7,100 tonnes a year. And then we tried to compensate for it with a variety of measures. One of the measures is to plant a new forest with half a million trees. The first 50,000 trees will be planted shortly. Since there is no CO₂ tax enshrined in law yet, that's how we pay it.

The EU is planning to be CO₂-neutral by 2050, and Austria by 2040. You want your company to be climate-neutral by 2025. Why so soon?

A good eight percent of global greenhouse gas emissions is attributable to the building material concrete. I believe this is far too much! We must act now and not wait until it is too late. I want an answer to the question of what the construction sector can contribute to a climate-neutral future. How can we - manufacturers and investors, architects and engineers - bring our energy consumption in line with what the planet can tolerate? I am hoping that the experiences we make during the Covid-19 pandemic will help accelerate things. Since the spring of 2020, we have had to quickly learn to adapt, be more attentive and do without things we are used to. This has fuelled the debate on consumption and the discussion on resilience. It is now important to take precise stock and to conduct a debate on recycling and the recycling economy taking into account actual energy consumption and grey energy, and to derive guiding principles from this.

What are the measures you want to implement to allow your company to reach this goal?

An important strategy is "Zero Waste", minimising the use of raw materials and waste in production and logistics, both in the pre- and post-consumer stage. We are switching to sustainable primary energy and by 2021 the cement content in our concrete matrix will have been reduced by 30 percent. That's a milestone!

This allows Rieder to become a role model for an entire industry, because after all, the company operates globally.

I see it as a privilege to break new ground with my company - with regard to reducing the CO₂ footprint. In the hope that some of this will bear fruit I would very much like this to encourage others to join in. Dialogue among the stakeholders in the construction industry is important: because if we have common goals, we can act faster and show others what's possible. This reminds me of a debate I had with Daniel Schrag, the director of the Institute of Environmental Science at Harvard. "What good are your 7,100 tonnes? We have to change the whole system!" he said. I think we need both: put our own house in order and try to make a difference globally.

You mentioned the relevance of concrete for the climate. How can it still be a sustainable product?

Our glassfibre reinforced concrete products are very slim, which means material consumption is low - that's a big advantage! Reducing material usage is an important issue generally. We invest between four and six percent of our budget in research and development, mostly with regard to the greening of our products and the entire production process. We took a look at our value chain and were shocked initially! At our worst, we used one square metre of fibreC for every 1.5 we produced. In other words: we produced 40 to 50 percent more material than ended up on the construction site. This is a disastrous figure - not just in terms of ecology. We optimised things, and now we are at 1 processed metre for each 1.2 square metres produced. But we are aiming for a one-to-0,8 ratio. This is an exciting business challenge, which will hopefully also be considered by architects, designers and investors. I believe innovation is not an end in itself, but rather an act of responsibility towards society.

”
*Our innovations
and sustainable ideas set
international trends.*

*We want our
operations and production to
be CO₂-neutral by 2025.*



What recent product developments are there in this context?

We developed a new product, the öko skin pixel, to reduce waste in the production of öko skin slats. Because of its granularity, it has a different aesthetic, it's not as perfect. We are planning a demonstration object that allows us to test it on the facade. We are developing a digital tool in cooperation with a partner. The software will take account of the amount of waste and generate project-specific design options for facades. We are also working on a closed loop system, which means taking our products back and feeding them into the production cycle. This of course raises logistical and technical questions, especially since our product is designed for durability without loss of quality.



öko skin pixel Mock-up

special | matt, ferro light, ferro

Not replacing facades as often definitely also contributes to sustainability.

Of course! That's why we also aim to produce facade elements that are as high quality as possible and also visually durable, meaning they don't go out of fashion too soon. It is important for us in this context to maintain a dialogue with architects and designers. One example is our product formparts, which can be used in a variety of ways to design facades with depth effect. One innovation involves the concrete skin panel. The 1.50-metre wide ones can now be produced in a length of 7 metres, which in turn opens up new possibilities.

You often cooperate with artists. Ron Terada, for example. One of his visual poetries – STAY AWAY FROM LONELY PLACES – keeps cropping up in connection with Rieder. What is it about?

Ron Terada uses it to draw attention to certain architectural spaces. We humans have a keen sense for places. None of us wants to visit places that have a bad atmosphere. It should therefore be our joint aim to create positive spaces - and this is what we want to achieve with our product and with our corporate goals.

Content

8

Material

fibrec

Qualities	10
Characteristics	12
Ecological indicators	14
Design	16
Colours	18
Surfaces	20
Textures	21
Finishes	22

24

Design

Products

concrete skin	26
öko skin	28
öko skin stripes	30
formparts	32
formparts.fab	34
formparts.mono	35
Inspiration	36

Services

Rendering to Realisation	40
Support of Design phase	41
Order process	44

Mounting

Ventilated curtain wall facade	46
Joint patterns and corner solutions	48
Special cuts	49
Undercut anchor	50
Rieder Power Anchor	50
Bonding	51
Rivets	51
Screws	52
öko skin hidden fix	52
Special solution formparts	53

54

Building

Services

Support of Building phase	56
---------------------------	----

Handling

Packaging	58
Transport	60
Receiving goods	61
Storage	62
Handling	63
Preparation assembly	64
Cutting	65
Drilling	66
Cleaning	67
Repair	68

70

Appendix

fibrec

Technical specifications	72
Norms and approvals	74
Perforation	76
Laying patterns for öko skin	77
Details formparts.fab	78
Details formparts.mono	79

Mounting

Details ventilated curtain wall facade	80
Details undercut anchor	84
Details Rieder Power Anchor	88
Details bonding	92
Details rivets	96
Details screws	99

General information

Notes	101
-------	-----

01 Chapter

Material



citizenM Tower of London, UK | Sheppard Robson

formparts.mono | liquid black | ferro | luce silver

fibrec

Qualities	10
Characteristics	12
Ecological indicators	14
Design	16
Colours	18
Surfaces	20
Textures	21
Finishes	22

Tip

The latest version of the "Facades Guide" is available for downloading at www.rieder.cc

Rieder has set itself ambitious goals: the company is to produce and operate in a CO₂-neutral manner in the coming years. And this claim is naturally also reflected in the products. The smaller the footprint, the more Rieder improves the architecture.

Ecological efficiency

Only very little fossil primary energy is consumed in the production of glassfibre reinforced concrete, which in turn results in low CO₂ pollution and a minimal greenhouse effect. Within the next 5 years Rieder will convert its entire production to 100 percent renewable primary energy.

Free of crystalline silicon dioxide

All Rieder products have always been free of crystalline silicon dioxide (< 1 M.-%) and are proven to be environmentally friendly.

Zero Waste

All offcuts from production can be used as by-products such as filling material for noise barriers or as substructure.

Passive solar contribution & shading

Rieder products also serve as sophisticated privacy and sun protection. The material contributes to the cooling and heating of drums as an efficient and innovative method. With building envelopes made of fibreC there is no "heat island effect".

Fire safety

Products made of fibreC guarantees absolute fire resistance: fire rating A1 - "non-combustible" approx. according to BBA Agrément Certificate 16/5362 for Great Britain and A2-s1,d0 - "non-combustible" approx. according to abZ Nr. Z-31.4.166 for Germany.

Individual design

fibreC sets no limits for designers and planners and meets the demands of modern architecture with unusual and complex design variations (colours, textures, surfaces, printing, perforation, blasting, embossments and shapes). Currently Rieder is offering a product range with 28,500 different combinations.

Ventilated curtain wall facade

Rieder facade cladding is designed as a mounted, ventilated facade in accordance with DIN 18516-1. This construction method, which distinguishes between thermal insulation and weather protection, is not only advantageous from the point of view of building physics, but also allows the creation of a variety of effects with different types of cladding.

Sustainable construction

In building certification systems such as DGNB, LEED and BREEAM, buildings with Rieder products achieve the highest standards.

High performance

fibreC withstands highest loads, is durable and yet individually applicable. The technical properties of fibreC are maintained over a service life of up to 50 years in all climate zones.



Rieder products are subjected to about 20 quality controls and only leave production in perfect technical and optical condition. The qualitative evaluation refers to all products of the fibreC family, and covers textures, surfaces and colours.

Visual impression

Concrete is a natural product and is regarded as such by Rieder. All facades made of fibreC have an individual character: vibrant surfaces with an interplay of colour shadings and cloud effects instead of artificial uniformity.

Natural raw materials

Rieder does not produce low-pore, homogeneously coloured and rigidly even surfaces because that does not correspond to the concept of sustainability. Rieder does not believe in chemical treatments or edge sealing of products.

Part of the surroundings

As adaptable and extraordinary as the concrete skin is, it is also authentic. Sustainable production methods as well as weather influences and temperature differences can cause characteristics such as blowholes, tension lines, cloud formation, dents and colour variations. These are natural and have no influence on the technical and static properties.

Play of light

Weather conditions, daylight, angle of light incidence - they all have an influence on the perception of the facade, especially with natural building materials such as concrete. To assess the facade, the material should be viewed in diffuse light. This corresponds to the lighting conditions that occur most frequently.

Viewpoint

In order to assess the optical properties of a facade, you need to be far away enough from the building to see all of it.

Library

Compare, view, touch, check, combine: the company has set up a library at the Kolbermoor location for architects, planners and building owners. The different characteristics of fibreC can be experienced and evaluated here. This provides the best possible basis for decisions.



By 2025, Rieder wants to reduce the primary energy requirements by 40 percent and the global warming potential by 50 percent. To this end the company is optimising production processes, supply chains and energy consumption.

LCA methodology was developed to provide an objective assessment. It is regulated in the DIN EN ISO 14040 standard. The following eco-indicators have been determined on the basis of this standard. This enables the ecological choice of building materials to be based on scientific findings. All material and energetic contributions of the individual processes involved in the production of a facade panel were considered. These include the extraction of resources, the provision of energy and the manufacturing processes of the required products. Emissions to air, water and soil were determined as part of the impact assessment. Listed below are three equivalence factors (environmental indicators):

Primary energy (PENRT)

The “total non-renewable primary energy content” (PENRT) is calculated from the upper calorific value of all those non-renewable energy resources that have been used in the production chain of the product.

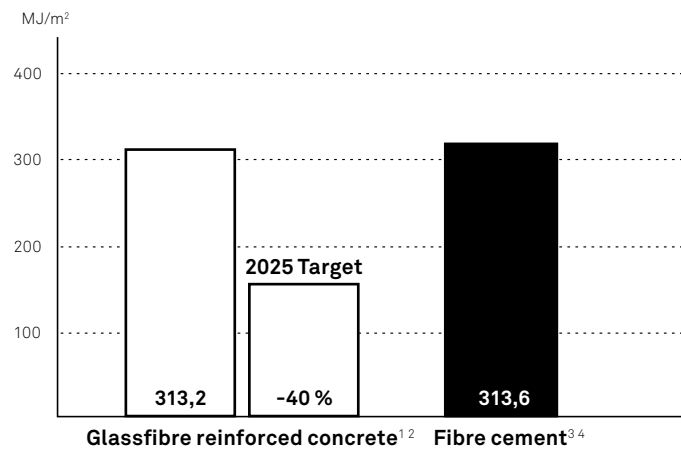

Global warming potential (GWP)

The global warming potential (GWP) describes the contribution of a substance to the greenhouse effect relative to the contribution of an equal amount of carbon dioxide.

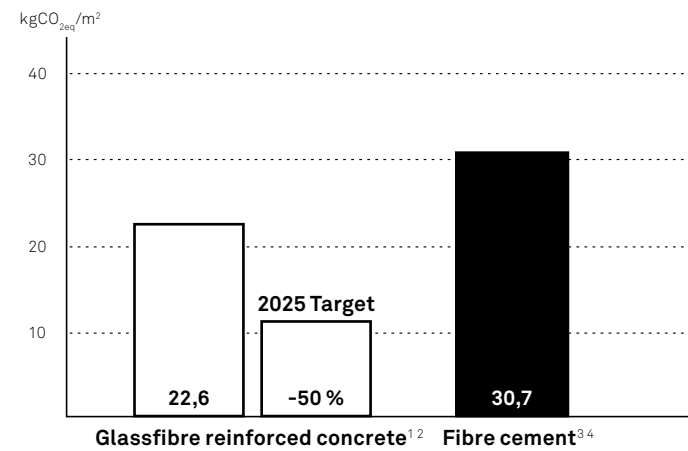

Acidification potential (AP)

Acidification is mainly caused by the interaction of nitrogen oxide (NO_x) and sulphur dioxide (SO₂) gases with other atmospheric constituents. The measure for the tendency of a component to become acidic is the acidification potential (AP).

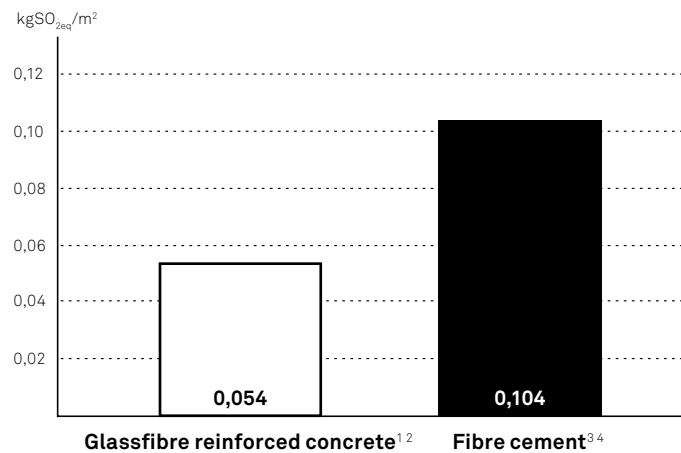

Ecological product

The comparison shows that, unlike other facade materials, the production of glassfibre reinforced concrete is very environmentally friendly. Experience has shown that the production of fibreC has about 15 % less greenhouse potential than aluminium facade panels. A number of publications show that fibreC consumes about 70 % less primary energy than HPL (High Pressure Laminate) panels. The values shown above are verified by IBO tests.

Sources

- 1) IBO (2020a): Austrian Institute for Building Biology and Ecology. IBO test report no. 47-3926, fibreC and öko skin glassfibre reinforced concrete panels, Vienna.
- 2) Characteristics corresponding to “(1)” for “terra” for a 13 mm thick panel and 29 kg/m² base weight
- 3) IBO (2020b): Austrian Institute for Building Biology and Ecology. Guideline values for ecological production use of fibre cement boards according to the IBO building material table, status 02/2020.
- 4) Characteristics corresponding to “(3)” for a 13 mm thick panel and 2000 kg/m³ gross density



Solstice on the Park, Chicago, USA | Studio Gang

concrete skin | anthracite, liquid black, sahara, sandstone | ferro



Tip
Product range
and sample order at
www.rieder.cc/product-range

Many textures

By adding different textures, Rieder offers a large number of individual possibilities to create unique facade claddings.

Custom made

From a project-related minimum quantity, special colours and textures can also be developed and produced at the customer's request.

Colours

fibreC has a decisive advantage over other colour treated materials - namely the solid colouring of the entire panel. The colour is part of the product because it is added when the raw materials are mixed.

Surfaces

The matt, ferro light and ferro surfaces open up a wide range of optical impressions and haptic experiences. The combination of different surfaces in the same colour creates a vibrant appearance.

Rieder's curated colour schemes offer a selection of coordinated shades to create the most authentic facades possible in harmony with nature and their surroundings.

greyscale

The love for the Alps and their peaks and valleys with their different rock forms led to the development of the greyscale colour collection. The seven shades of grey symbolise the transition from dark to light stone and express the natural character of concrete.

pietra

The light colours of pietra radiate warmth and lightness. They refer to the fine structure of sandstone and its calm colour nuances, which are as elegant as they are down-to-earth.

Tip
Colour overview at www.rieder.cc

bricky

bricky was inspired by the traditional brick building method. The collection is both colourful and vibrant. It is based on red tones reminiscent of powerful brick architecture.

timber

In the development of this collection Rieder used colour shades that reflect the restrained but diverse colour world of native forests. timber is reminiscent of woods and bark as well as pine needles on forest floors.



The material is given an individual optical and haptic character depending on the treatment of the surface of the concrete. With the appropriate surface treatment, facades are given an elegant to rustic aesthetic. With a matt surface, colours appear more saturated, while blasting makes them appear less intense.

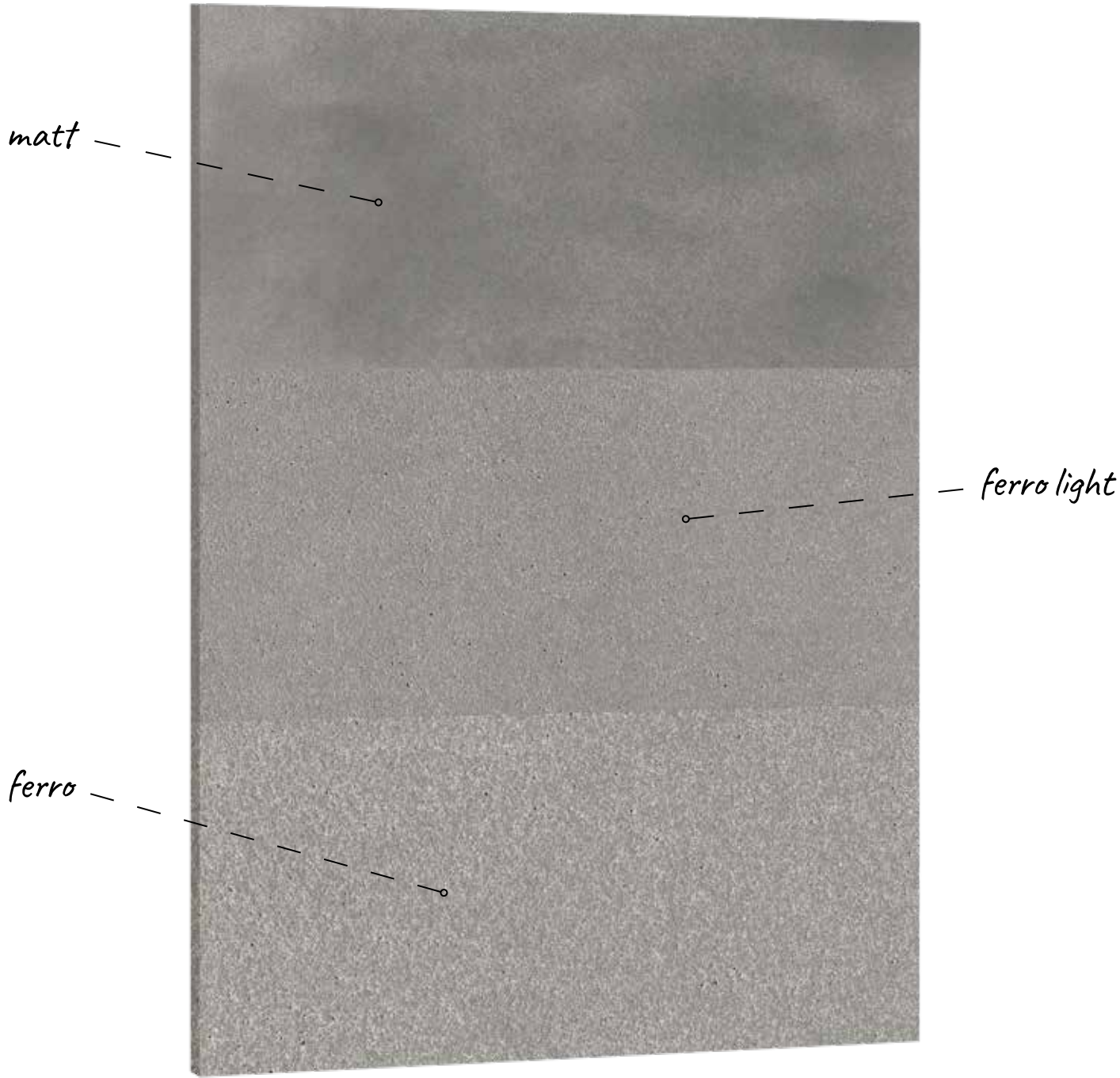

Textures and aggregates lend the building envelope more depth and vibrancy. The different structures create an exciting interplay of light and shadow, which changes depending on the viewpoint. These give architects more scope for individual ideas. The different characteristics highlight the naturalness of concrete and emphasise its authentic appearance.

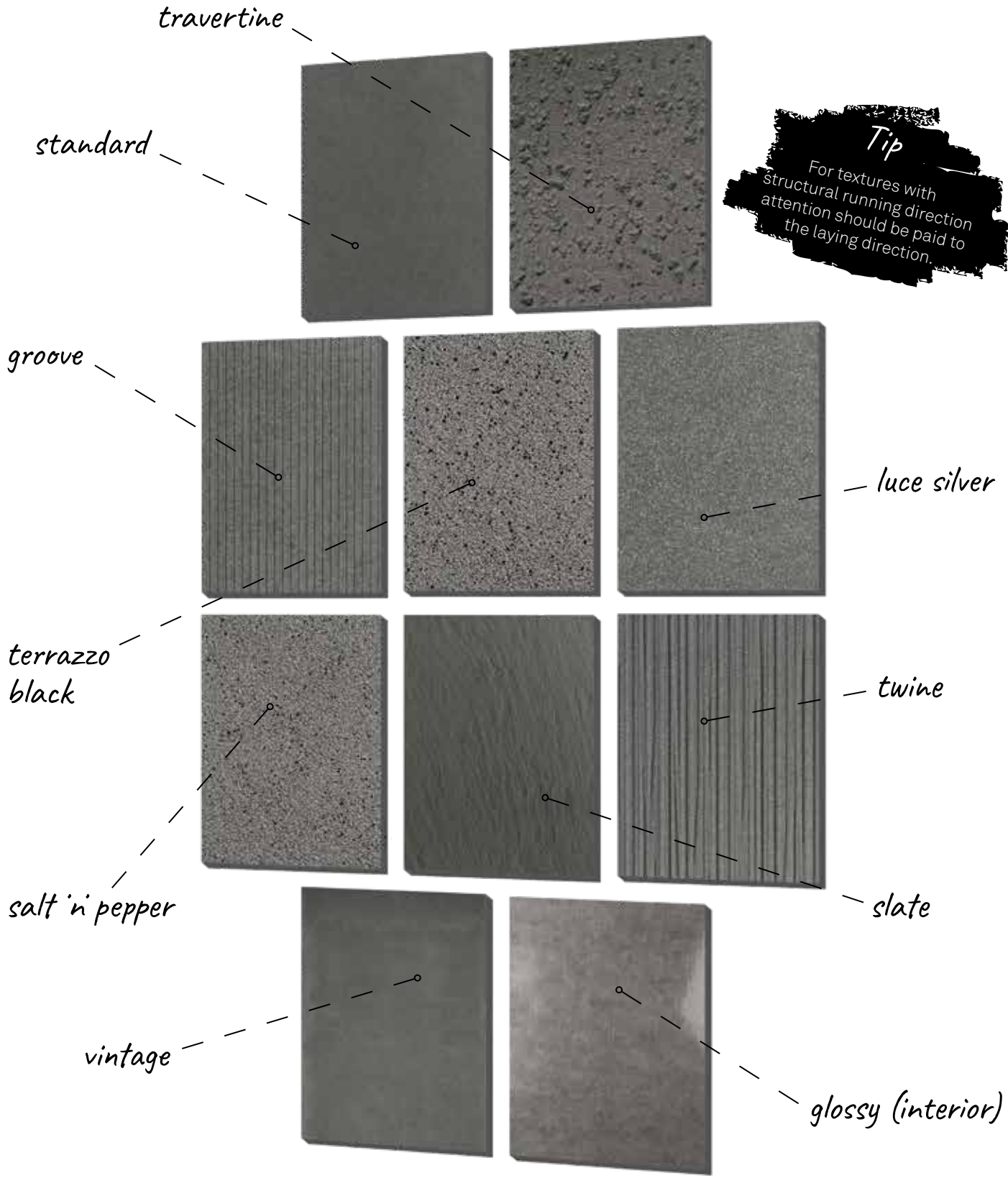

Small air inclusions and pore formation are possible: Leaflet on exposed concrete 02/2004 (publisher: BDZ/DBV).

fibreC offers numerous possibilities to create patterns, to profile decorations or lettering, to print pictures or to incorporate a relief-like surface.

Perforation

A water jet can be used to cut individual shapes or letters out of the panel.

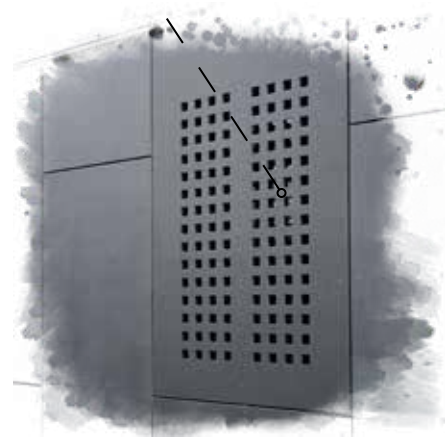

Tip

Planning details for perforation on page 76 in the appendix

Blasting

By using specially manufactured blasting foils, patterns, characters or logos can be blasted permanently onto the panel surface.

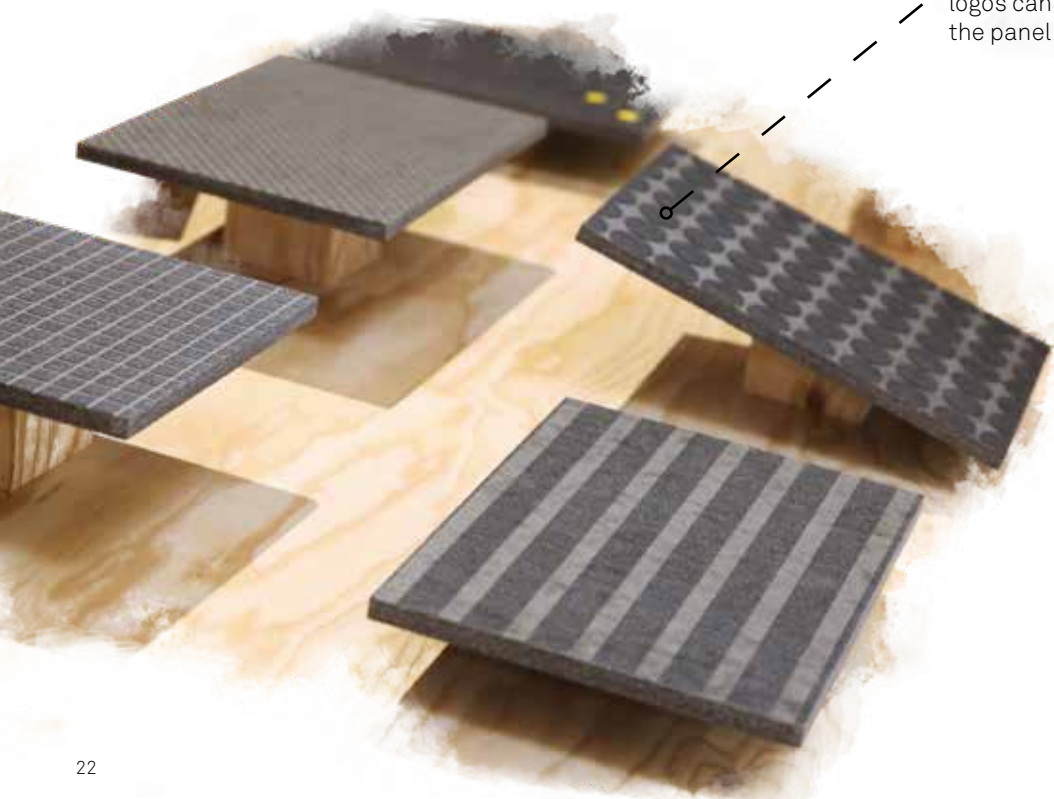

Digital & screen printing

fibreC panels can be printed on using digital and screen printing techniques. The printing of images, photos, patterns and text is suitable for both outdoor and indoor use.



Relief

Special reliefs with embossed surface and plastic appearance are possible. Individual structural wishes can be implemented.

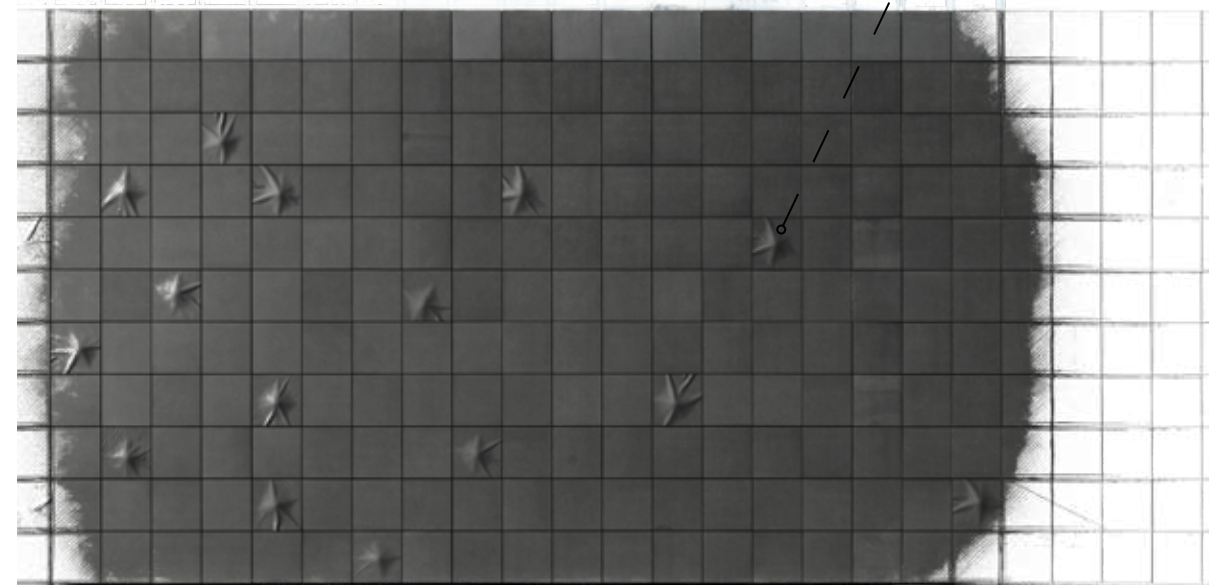

02 Chapter

Products

concrete skin	26
öko skin	28
öko skin stripes	30
formparts	32
formparts.fab	34
formparts.mono	35
Inspiration	36

Services

Rendering to Realisation	40
Support of Design phase	41
Order process	44

Mounting

Ventilated curtain wall facade	46
Joint patterns and corner solutions	48
Special cuts	49
Undercut anchor	50
Rieder Power Anchor	50
Bonding	51
Rivets	51
Screws	52
öko skin hidden fix	52
Special solution formparts	53

Design



The stable panels, only 13 mm thick, open up a wide scope for the realisation of ideas. Literally like a skin, concrete skin stretches smoothly over buildings and, in combination with formparts, over corners and edges. This creates a unique flow of material.

Performance

concrete skin withstands the highest loads. Due to their robust properties, the panels are weatherproof and have a long service life.

Size

Since the enormous panel sizes mean that there is no need to interrupt the material, there is a wide range of possible applications and shapes. concrete skin is unique in that it can be used to give the impression that a building was constructed in one piece and allows the material to appear in its purity.

Individuality

The format is freely configurable within the maximum sizes. Individual shapes, colours, textures, surfaces and perforations offer numerous possibilities.

Mounting

Visible: rivets, screws
Concealed: bonding, undercut anchor, Rieder Power Anchor

World's first
Length: 7000 mm
on request



Formats

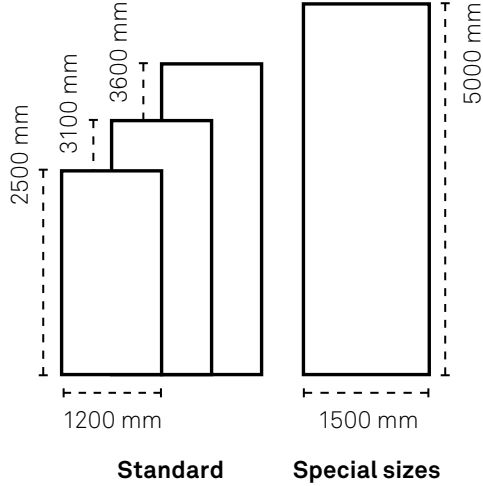

With öko skin, Rieder offers slatted concrete facades. The various surface design options create a vibrant play of colours. The slats can be installed with little effort and, unlike wood, never need to be painted or sanded.

Durability

öko skin creates facades that require minimal maintenance. Due to their robust properties, the slats are weatherproof and have a long service life.

Flexibility

öko skin is excellently suited for cladding large building facades. But also, for small projects, such as porches, conservatories, summer houses, garages or fences, öko skin with its versatile textures and the matt, ferro and ferro light surfaces, is a proven product.

Mounting

Visible: rivets, screws
 Concealed: öko skin hidden fix, bonding, undercut anchor, Rieder Power Anchor

Formats

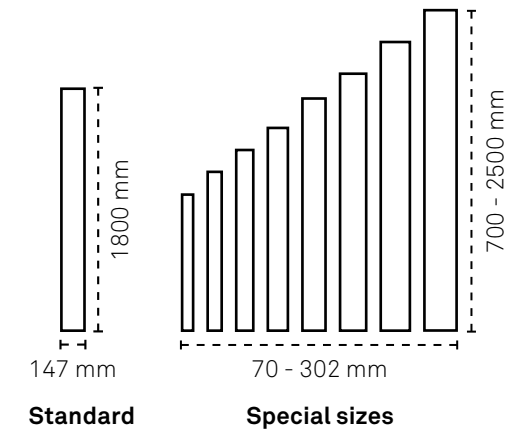

öko skin stripes in three different widths offer architects numerous new design possibilities for facades. The product is available in various colours and can be delivered in a predefined sequence.

Predefined

The mix of colours and surfaces and the sequence of the three slat widths can be predefined. They can be pre-assembled in a modular way.

Palletising system

There are 18 layers on a pallet. Each layer consists of 8 slats (4 x 70 mm, 2 x 147 mm, 2 x 302 mm). In total, a pallet thus offers approx. 54 m² with a slat length of 2500 mm and approx. 66 m² with a slat length of 3100 mm.

Mounting

Visible: rivets, screws
 Concealed: bonding, Rieder Power Anchor



Formats

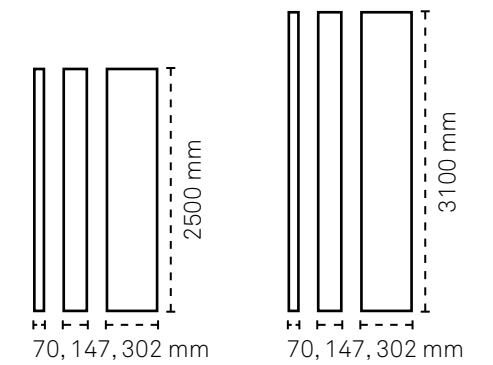

formparts are monolithic concrete elements which offer a high degree of flexibility and various design options for architectural concrete. The shaped concrete elements with their perfect mounting system enhance glass facades, protect your privacy and serve as clever sun protection.

Advantages

formparts are custom-made and can be pre-assembled in the factory, which means weather conditions are irrelevant. This guarantees a high-quality standard and rapid assembly on site. The elements are simply hooked in and tweaked into place.

Colours, surfaces & textures

formparts are available in various colours, surfaces and textures. Details of the constraints resulting from the production process are provided on pages 78 and 79 of the appendix.

Mounting

Visible: rivet, screw
 Concealed: undercut anchor, Rieder Power Anchor, bonding



Sharp-edged corner solution

Round corner solution

Shapes

formparts enable complex 3D shapes with round and sharp-edged corner solutions. Positive and negative angles can be combined.

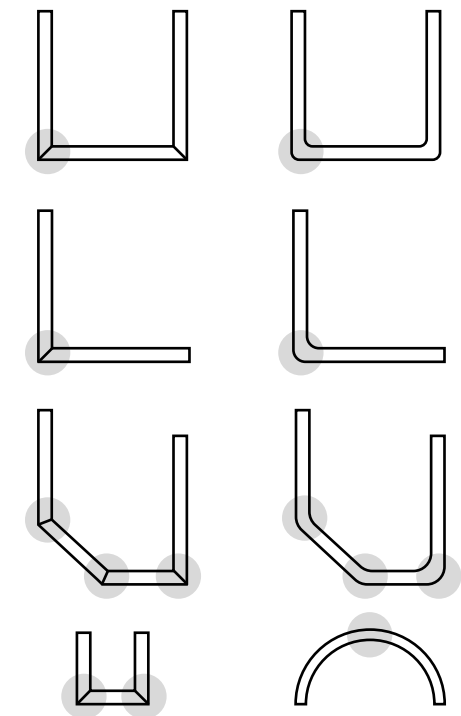

R2R Library

formparts are manufactured individually for each project. This results in many different possible designs and mounting methods. Over the years Rieder has created a comprehensive library of solutions for formparts. Excerpts from this R2R Library are available on request.

The large unwinding width means that several different formed parts can be combined with each other. Various surfaces and textures are available, which can be individually combined with each other.

Economical

As no shuttering is necessary, formparts.fab are very attractive especially for small runs.

Manufacturing

formparts.fab are cut from panels and later joined together at different angles. With this method, the sharp edges can be formed with a chamfer of $2\text{ mm} \pm 1\text{ mm}$.

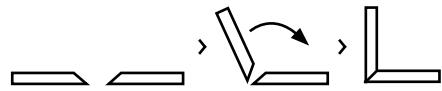

Formats

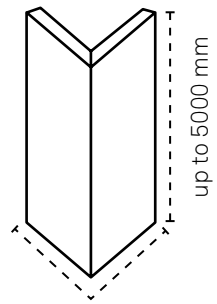

up to 2000 mm
(unrolling width)

The curved elements are custom-made and are available with L- or U-cross section, as round arches and special shapes.

Advantages

Because of the low weight of the formed parts and their high inherent stability, less substructure is required than with formparts.fab.

Manufacturing

formparts.mono are manufactured from one panel using folding moulds. This results in the characteristic edge radius. Standard: 3-15 mm and optionally: 3-9 mm (small), 10-15 mm (medium), > 15 mm (large).



Formats

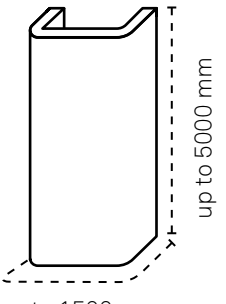

up to 1500 mm
(unrolling width)



Lichtfabrik, Berlin, Germany | Bollinger + Fehlig Architects, Stoeckert Architects

formparts.fab | ivory | ferro



Marine Base Amsterdam, Netherlands | bureau SLA

concrete skin, formparts.mono | liquid black | ferro



01

öko skin pixel coming 2021!



02

Tip
More inspiration from www.rieder.cc/projects as well as at Pinterest, Instagram and Facebook



Element construction



03

01_öko skin pixel Mock-up in Maishofen, Austria. Clad with öko skin pixel in special with matt, ferro and ferro light. 02_ZAC Moulon & Polytechnique in Palaiseau, France, by Hélène Fricout-Cassignol Architects. Clad with concrete skin and formparts.fab in polar white with matt. 03_Variowohnungen in Bochum, Germany, by ACMS Architects. Clad with öko skin in anthracite with matt, ferro light and ferro.

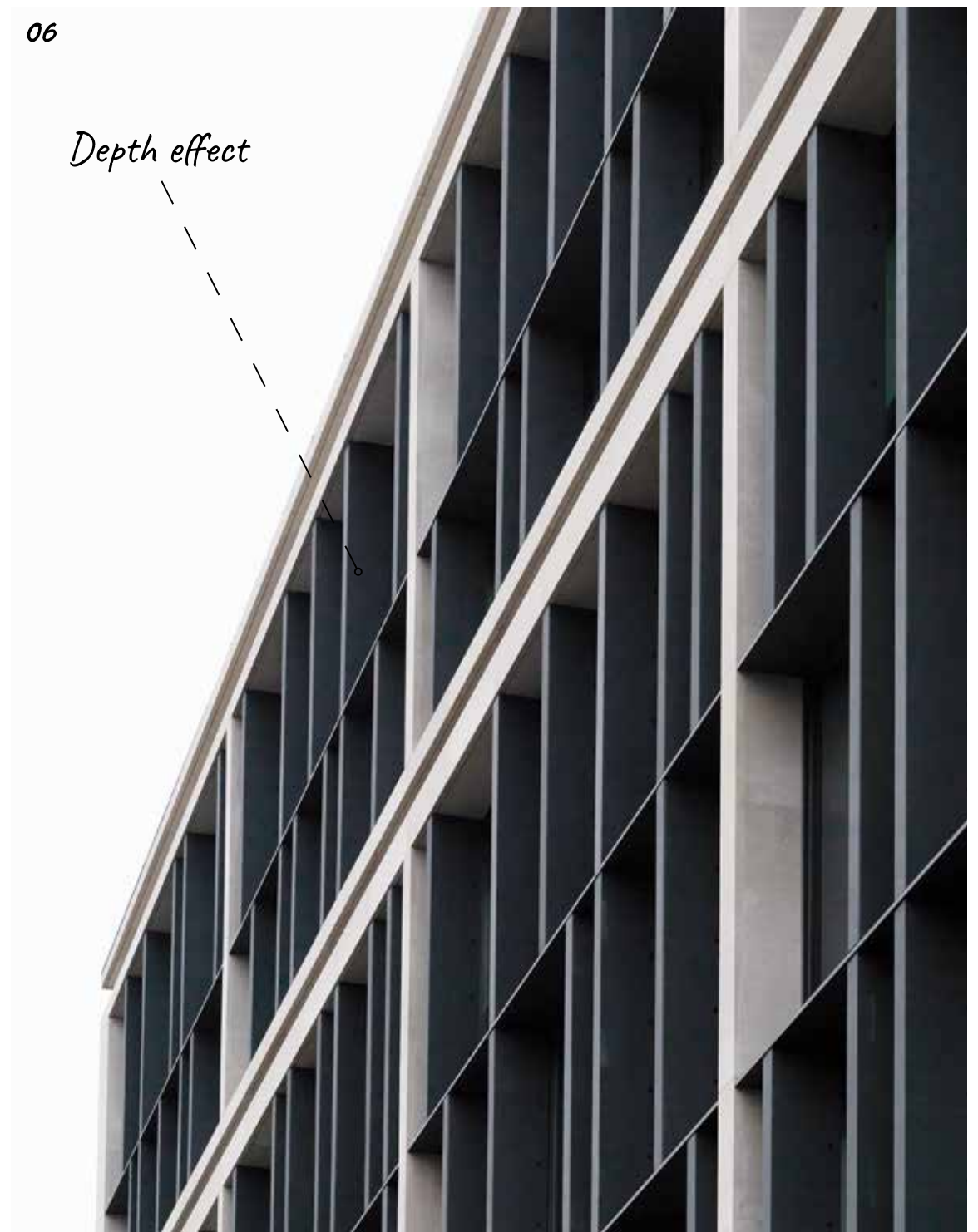
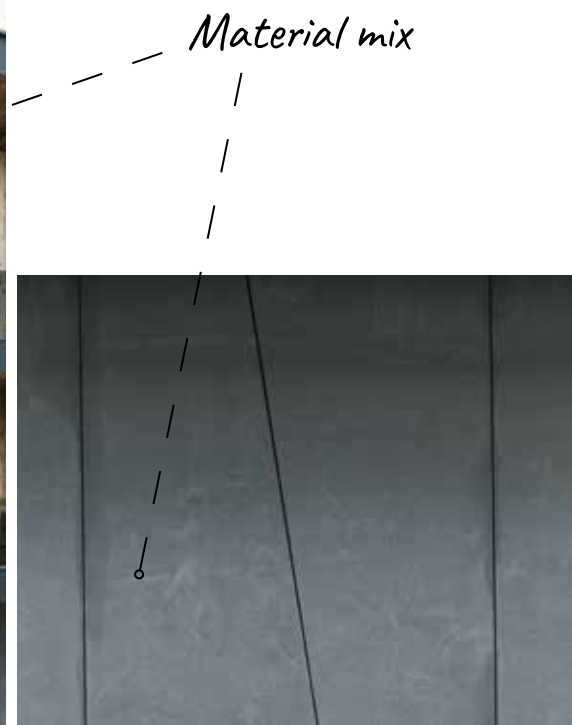

04_Reithergasse residences in Kirchberg, Austria, by architecture firm Ing. Franz Obermoser. Clad with concrete skin in anthracite with vintage matt. **05_ZAC Paul Bourget 7** in Paris, France, by Martin Duplantier Architects. Clad with concrete skin and formparts.mono in liquid black with ferro. **06_citizenM Tower of London**, UK, by Sheppard Robson. Clad with formparts.mono in liquid black with luce silver ferro.

Rieder's facade specialists and their well-established network are available to support architects and planners in all project steps, from the early planning phase to implementation. R2R "Rendering to Realisation" describes Rieder's integrative approach to developing a holistic solution for building envelopes.

#1 Drafting idea

After the initial planning phase, the customer approaches the facade specialists at Rieder with a concrete idea of a building shell.

#2 Know-how from Rieder

In consultation with the client, the project is discussed in detail, individual solutions are worked out and different options are presented.

#4 Development of the substructure

Depending on your ideas, project-specific substructures are designed to meet the requirements of a sustainable and economical building shell.

#3 Planning & construction

Based on the results of the consultation, a tailor-made facade concept is created and all necessary details for the planning itself are worked out.

#5 Detail planning

Rieder compiles all essential details for the project.

#6 Logistics concept

Precise concepts are created, from the delivery to the specific assembly.

#8 Presentation

The final comprehensive solution proposal for the building envelope is presented and discussed together.

#7 Calculation

On the basis of the data obtained, an offer is drawn up to give the client an idea of the costs involved.

Concept planning, design development & solution finding

- > Transferring the idea into a feasible facade
- > Comparison of design with production technology
- > Advice on technical possibilities
- > Making libraries available
- > Approval and workshop planning



BIM - Building Information Modeling

- > Rieder offers planning details and all technical drawings in BIM-standard
- > High-resolution photos of colours, surfaces and textures available for downloading

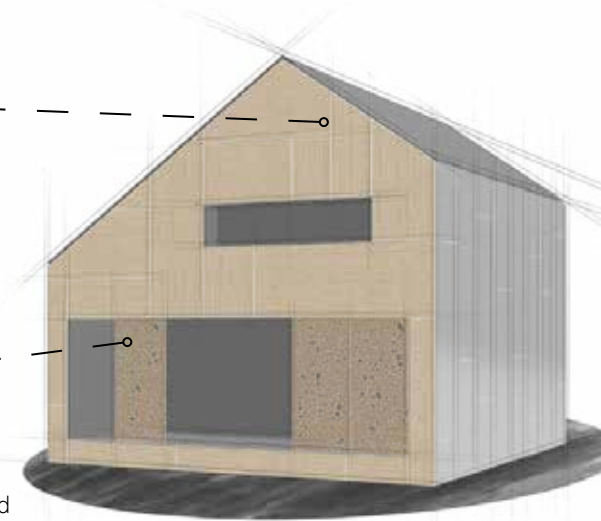

Digital product design

- > Digital development of textures and colours according to clients' wishes
- > Digital sample available within 7 days
- > Overview of product combination possibilities on www.rieder.cc/product-range

Texture development & sampling

- > Development of tailor-made textures
- > Sampling of colours, surfaces and textures using viewing samples
- > Rieder offers comprehensive advice on products, applications and solutions.



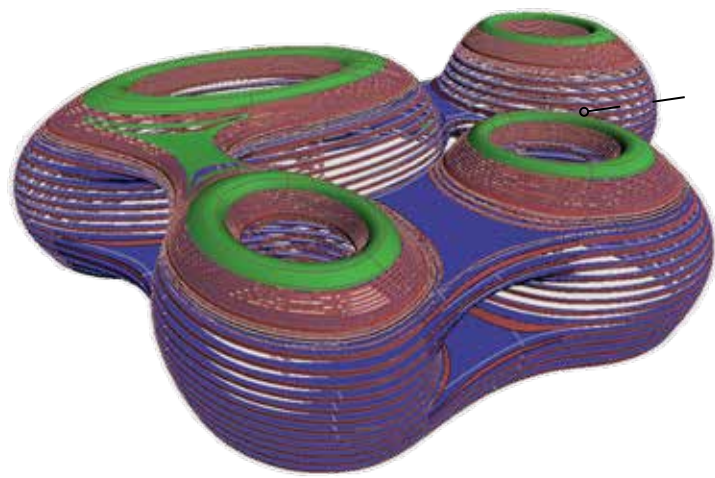

Rationalisation

- > Transfer of design and smoothing with 3D model
- > Dissection of the building envelope into flat and shaped elements
- > Optimisation of the facade layout
- > Comparison with production parameters
- > Calculation basis for economic feasibility

Development of the type of mounting

- > Development of the element substructure from statics
- > Working out the connections to the substructure of the building
- > Simulation of assembly steps
- > Development of individual mounting solutions

Static calculation & building physics

- > 3D calculation of element statics by Finite Element Method (FEM)
- > Static calculation of the element at every position
- > Determination of the actual need for fixing points, spacing of the substructure etc.
- > Requirements for primary element substructure

Mock-ups & prototyping

- > Transfer of the concepts into practice
- > Preparation of a Mock-up for evaluation of the optical expectations of the architectural performance
- > Technical testing, simulation of weathering, wind loads etc.
- > Optimisation and approval

Approval in individual cases

- > Should approval be required in individual cases for a specific project, Rieder offers this as an optional service.
- > All applicable national regulations are taken into account.
- > Clarification of technical tenders



The satisfaction of Rieder's customers is the primary goal. To assure that all products are ready for pick-up at the desired date, it is crucial for the entire ordering process to run smoothly. The following timelines illustrate the most important milestones¹. The amount for the 1st call-off depends on sizes, geometries and container load.

Tip
Ordering templates ("Rieder Order List" incl. instruction, dxf templates) available for download at www.rieder.cc

Process (example)¹

CS

- concrete skin** (incl. cuttings & drillings)
- > Concerns standard sizes (1200 x 2500, 3100, 3600 mm)
 - > 1st call-off max. 650 m²
 - > Completion date 8 - 9 weeks from approval of production plans by the client

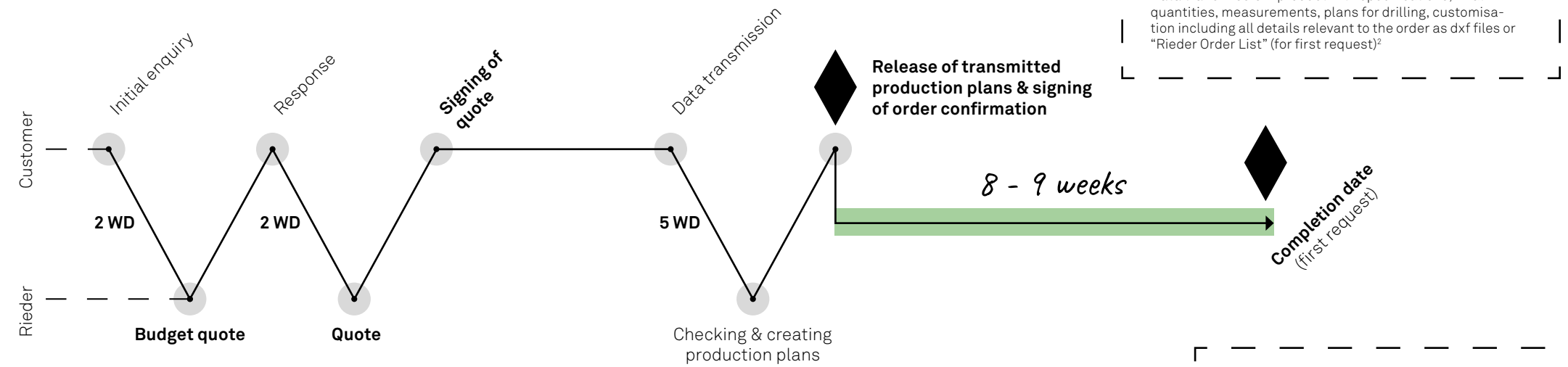

concrete skin

Initial enquiry: product with specifications, net area in m²

Response: product with specifications, net area in m², services, desired deadline per request

Data transmission: product with specifications, final quantities, measurements, plans for drilling, customisation including all details relevant to the order as dxf files or "Rieder Order List" (for first request)²

ös

- öko skin**
- > 1st call-off max. 650 m²
 - > Completion date 5- 6 weeks from the signature date of the quote/order confirmation

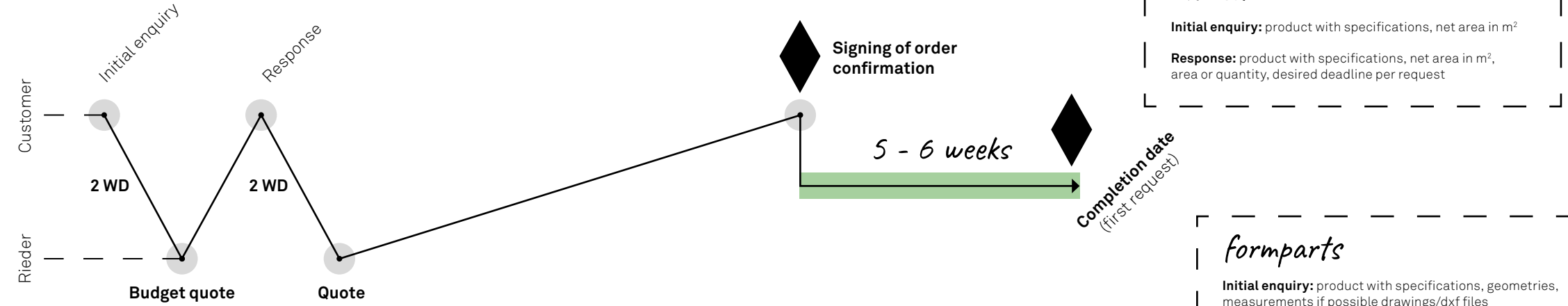

öko skin

Initial enquiry: product with specifications, net area in m²

Response: product with specifications, net area in m², area or quantity, desired deadline per request

fp

- formparts**
- > 1st call-off max. 150 rm (depending on geometry and sizes)
- formparts.fab** (sharp-edged corner solution)
- > Completion date 9 - 10 weeks from the approval of production plans and signed order confirmation
- formparts.mono** (round corner solution)
- > Completion date 12 - 14 weeks from the approval of production plans and signed order confirmation

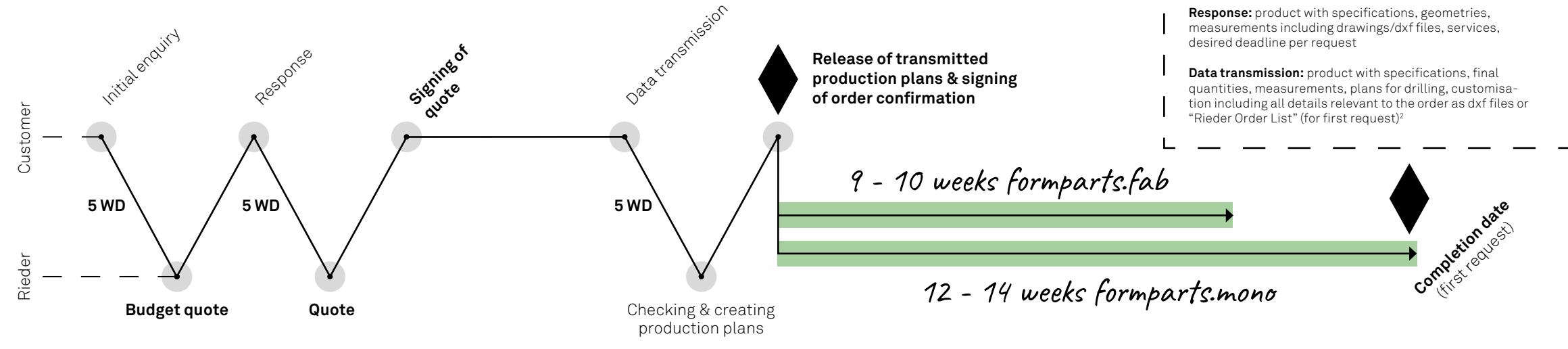

formparts

Initial enquiry: product with specifications, geometries, measurements if possible drawings/dxf files

Response: product with specifications, geometries, measurements including drawings/dxf files, services, desired deadline per request

Data transmission: product with specifications, final quantities, measurements, plans for drilling, customisation including all details relevant to the order as dxf files or "Rieder Order List" (for first request)²

WD = working days

¹ Excluding special colours, surfaces and textures, lengths over 3600 mm, widths over 1310 mm; all specifications are approximate values.
² If the transmitted data does not correspond to Rieder's specifications, it is the customer's responsibility to change the data and resend it.

Sample and Mock-up processes are regulated in a supplementary sheet (online at www.rieder.cc/downloads).

Ventilated curtain wall facade | Mounting

The system of the ventilated curtain wall facade (VCWF) is characterised by a constructive separation of the two components, insulation and cladding.

Since the space created in between regulates the heat management of the building, the characteristic structure of the VCWF leads to a number of advantages in terms of building physics and economics. Besides individual freedom of shape and colour of the fibreC products, visible or concealed fixings can achieve additional aesthetic effects.



Durable & economical



Protection against driving rain & condensation



Fire safety



Freedom of design

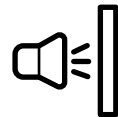

Impact noise insulation

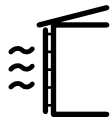

Heat, cold & hail protection

Tip
Ensure correct background ventilation as required in the approval!

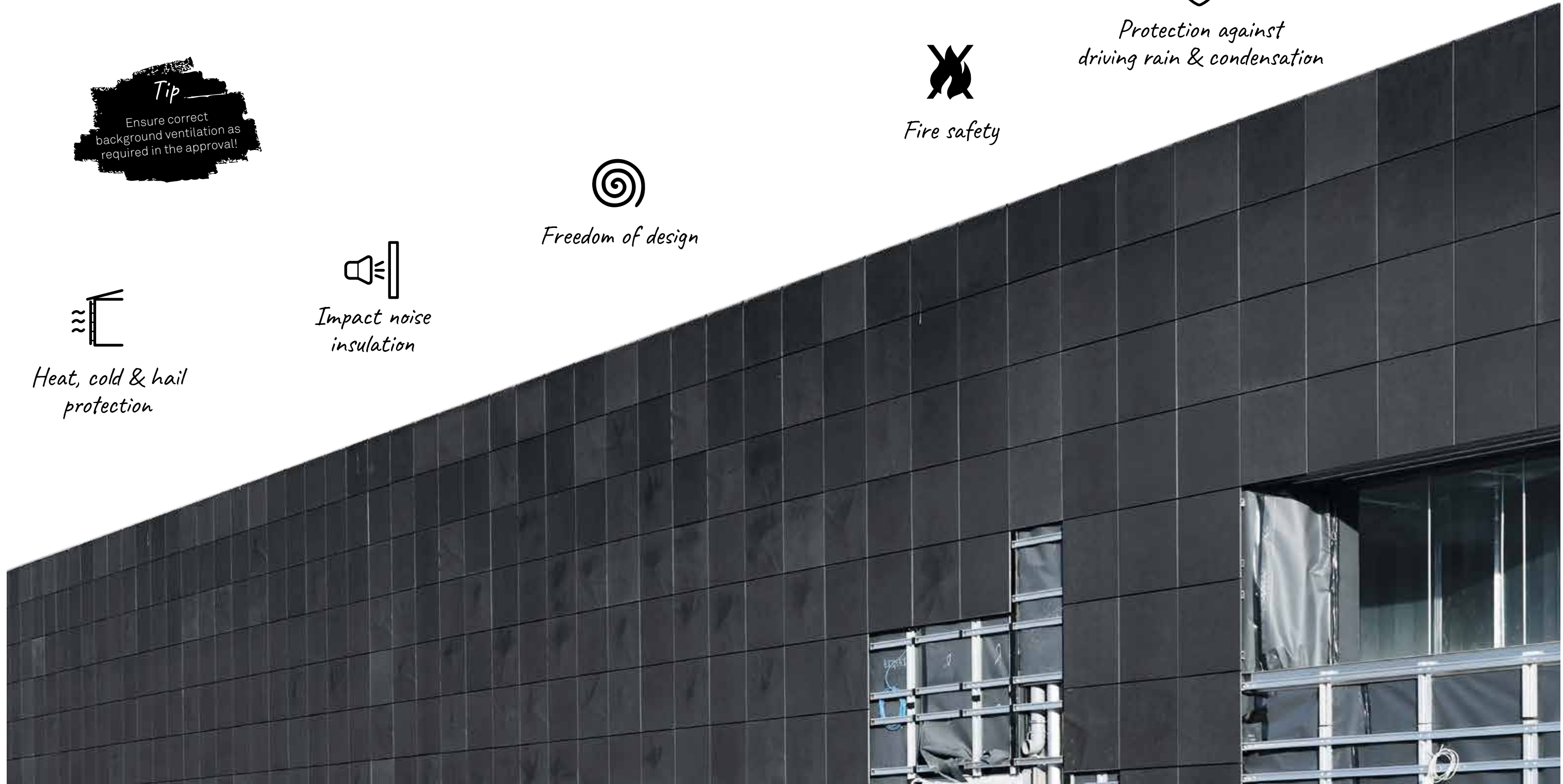

Open joints

Panel connections with an open joint do not impair the continuous homogeneous appearance of the facade.

Closed joints

The joints are closed by means of joint profiles, which can be made in different colours and dimensions.

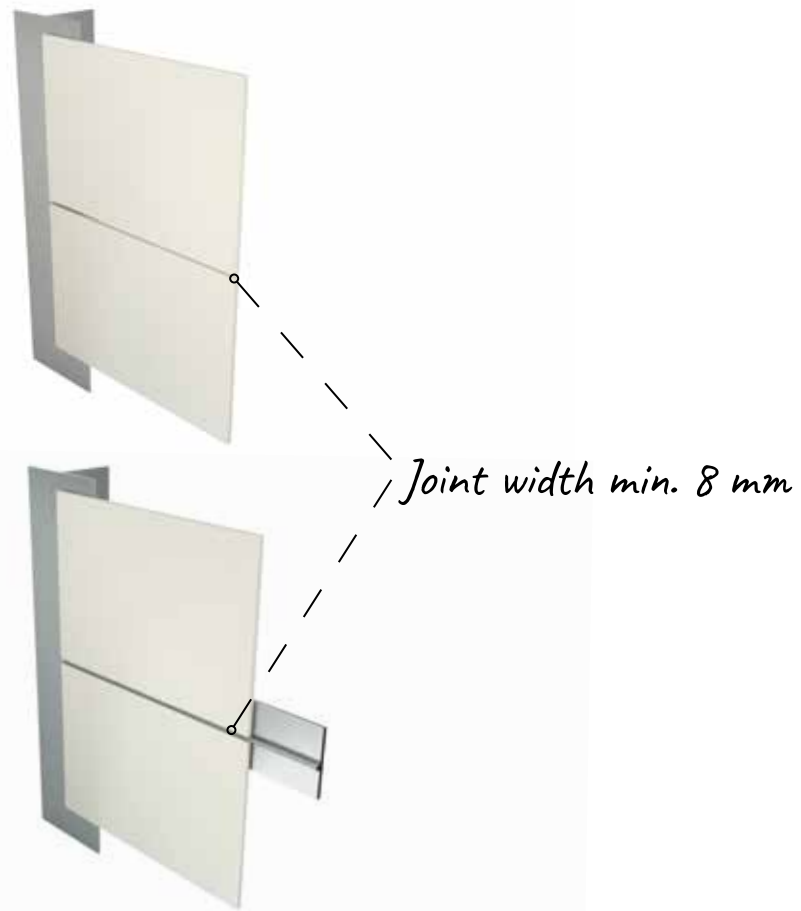

Corner solutions - open joint

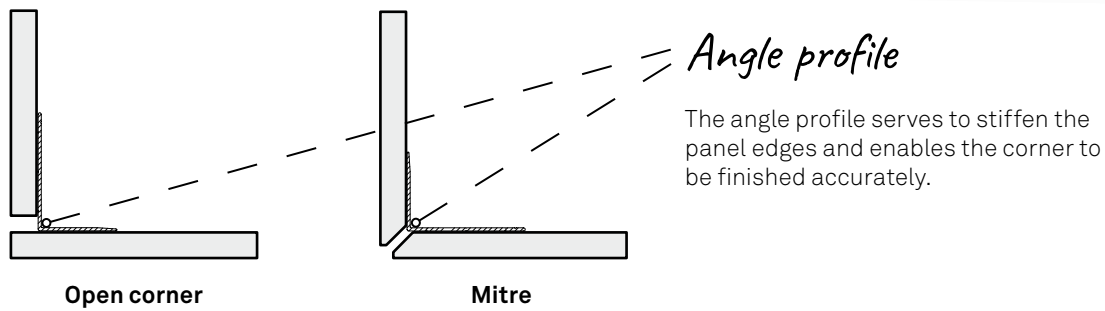

Corner solutions - closed joint

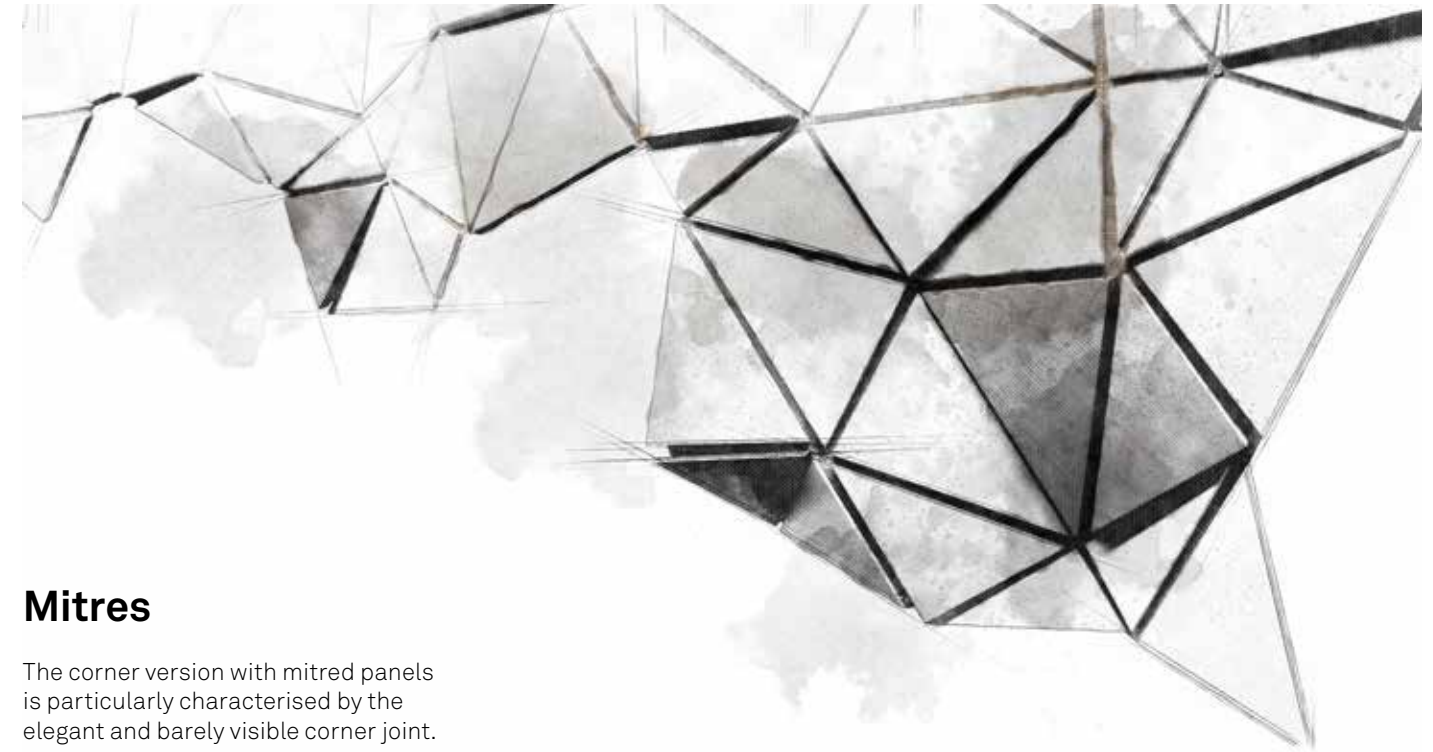
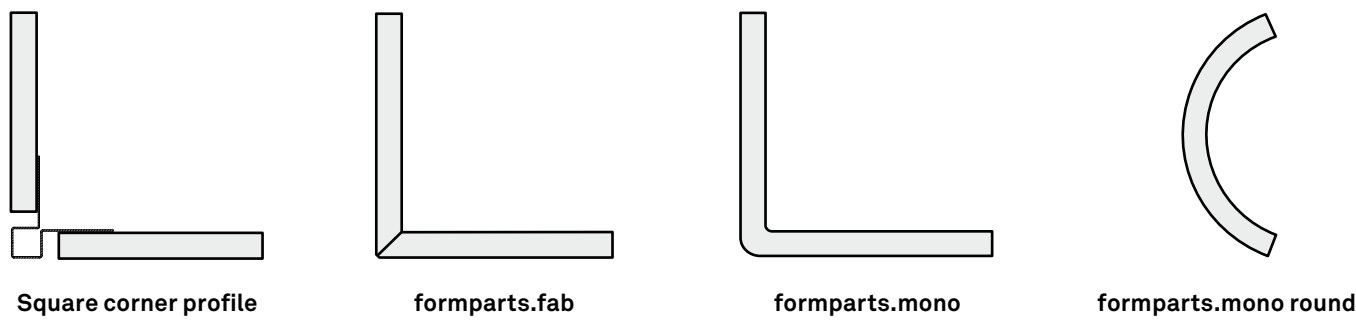

Mitres

The corner version with mitred panels is particularly characterised by the elegant and barely visible corner joint.

- > Residual edge tolerance: ± 1 mm
- > Tolerance degree of the cut edge: $\pm 2^\circ$

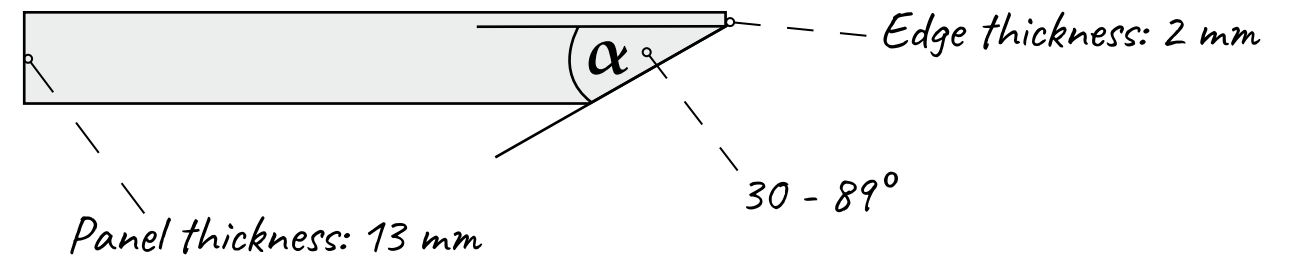

Angled cut

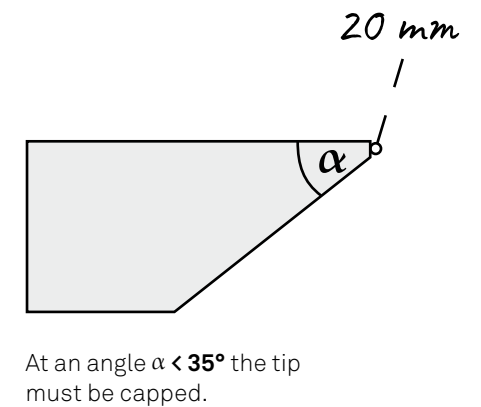
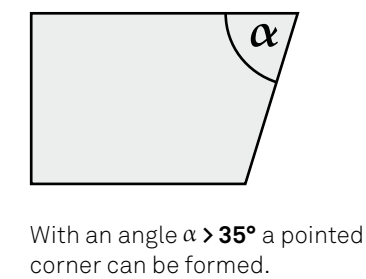
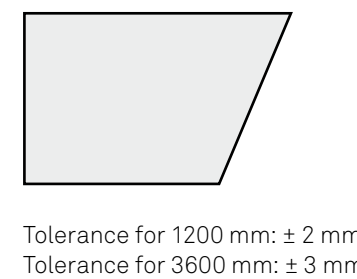

Undercut anchor | Mounting

Panels can be fastened with metal clasps or alternative project-specific substructures and special undercut anchors, which are not visible on the rear side. The position of the substructure or type of agraffes (single or double agraffes) depends on the respective load application.

Tip

Details to the types of mounting on page 84 of the appendix

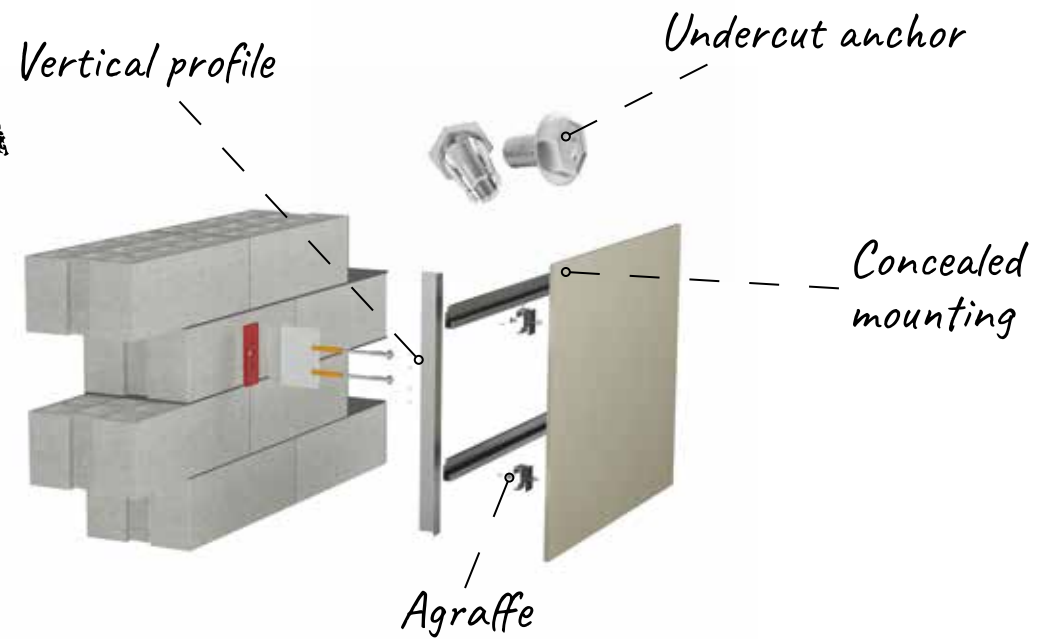

Bonding

Panels can be mounted invisibly on an aluminium substructure by means of force-locking bonding.

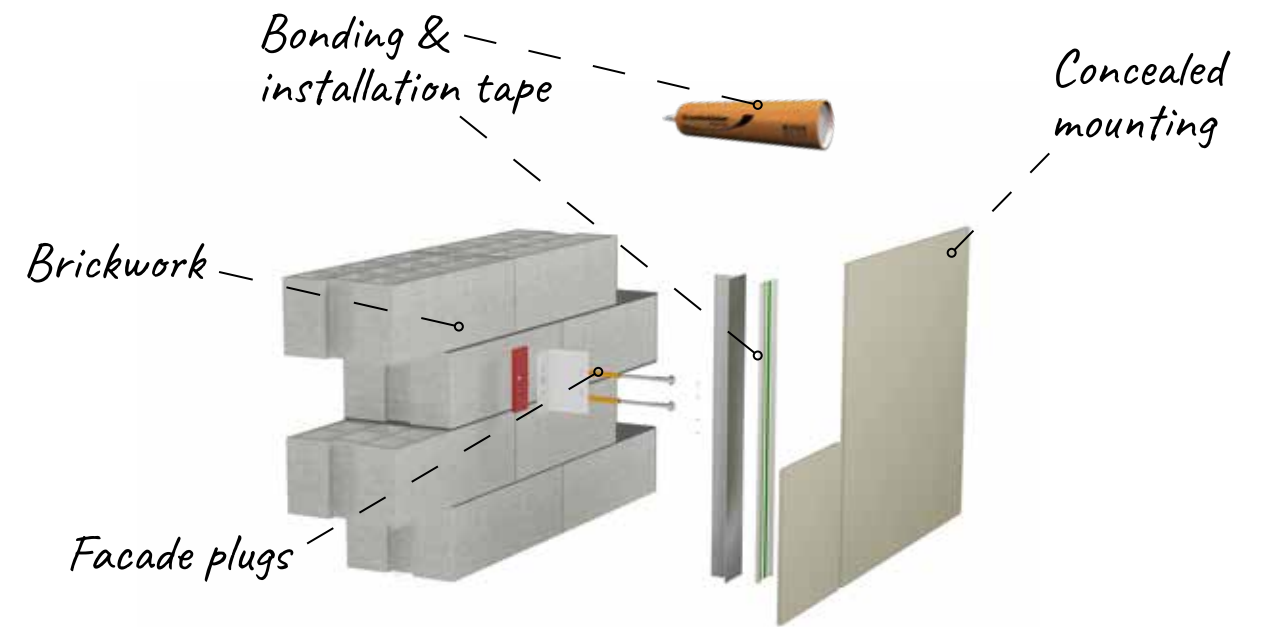

Rieder Power Anchor

Panels can be fastened with metal clasps or alternative project-specific substructures and special Rieder Power Anchor non-visible on the rear side. The position of the substructure or type of agraffes (single or double agraffes) depends on the respective load application and has to be evaluated by the processor in terms of design.

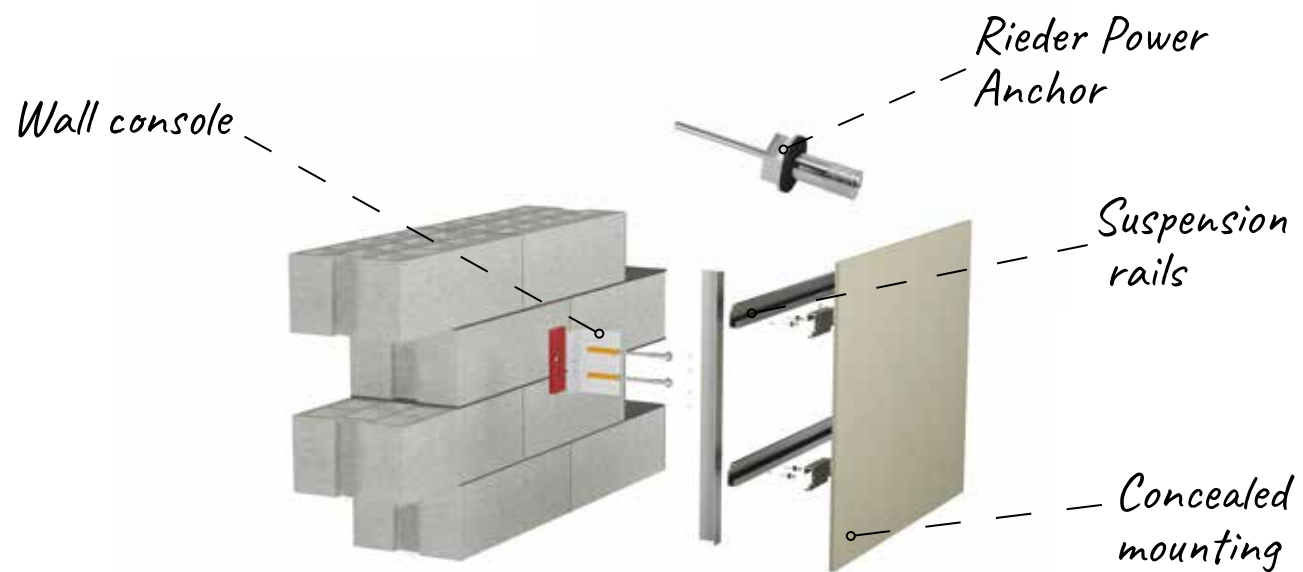

Rivets

The panels can be fastened with rivets to a metal substructure with a positive fit. Preferably, the substructure consists of vertical profiles, which are mounted to the wall using wall bracket holders.

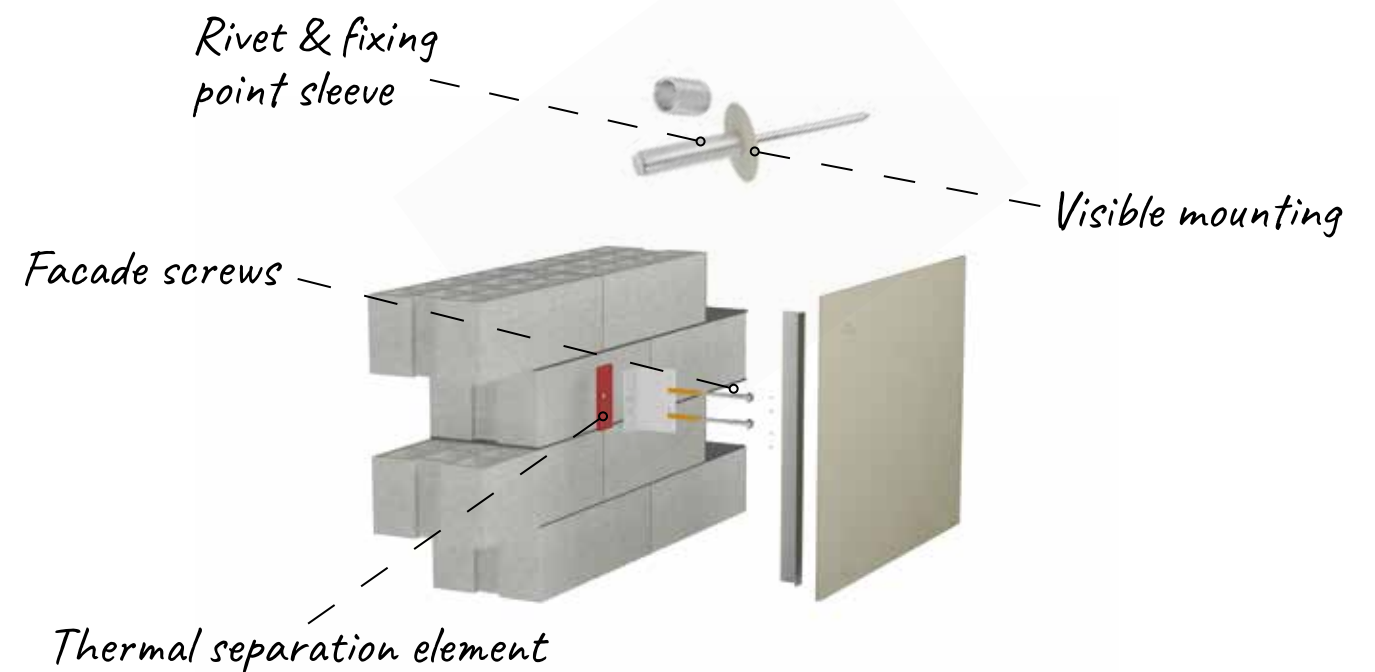

According to the approval, the permissible building height for the use of the panels depends on the applicable fire protection regulations of the respective countries. Combinations of attachment options are not foreseen and must be tested as needed from design technology, structural and construction physics aspects. Assembly must be tension-free regardless of the attachment system that is used.

Screws

The panels can be fastened to a metal or wooden substructure with suitable screws. The substructure consists of vertical profiles, if possible, which are mounted to the wall using wall bracket holders.

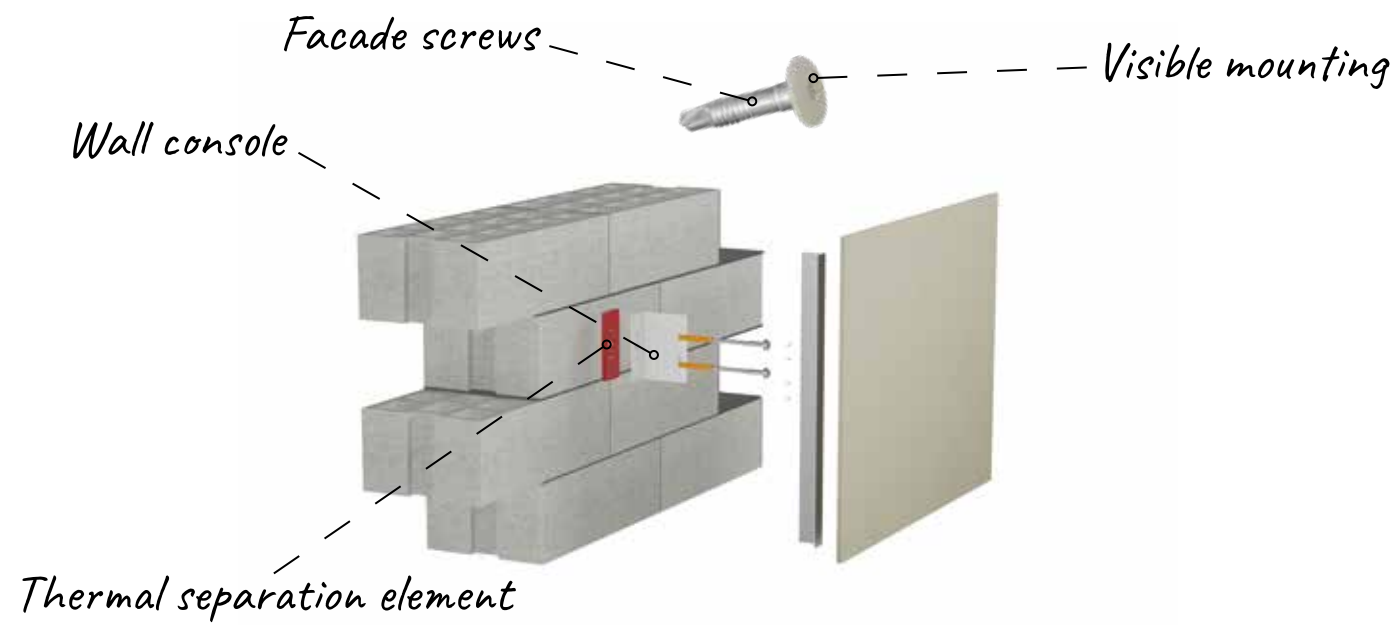

öko skin hidden fix

The concealed mounting system hidden fix for öko skin facade slats in the standard format 1800 x 147 mm allows a simple and quick installation.

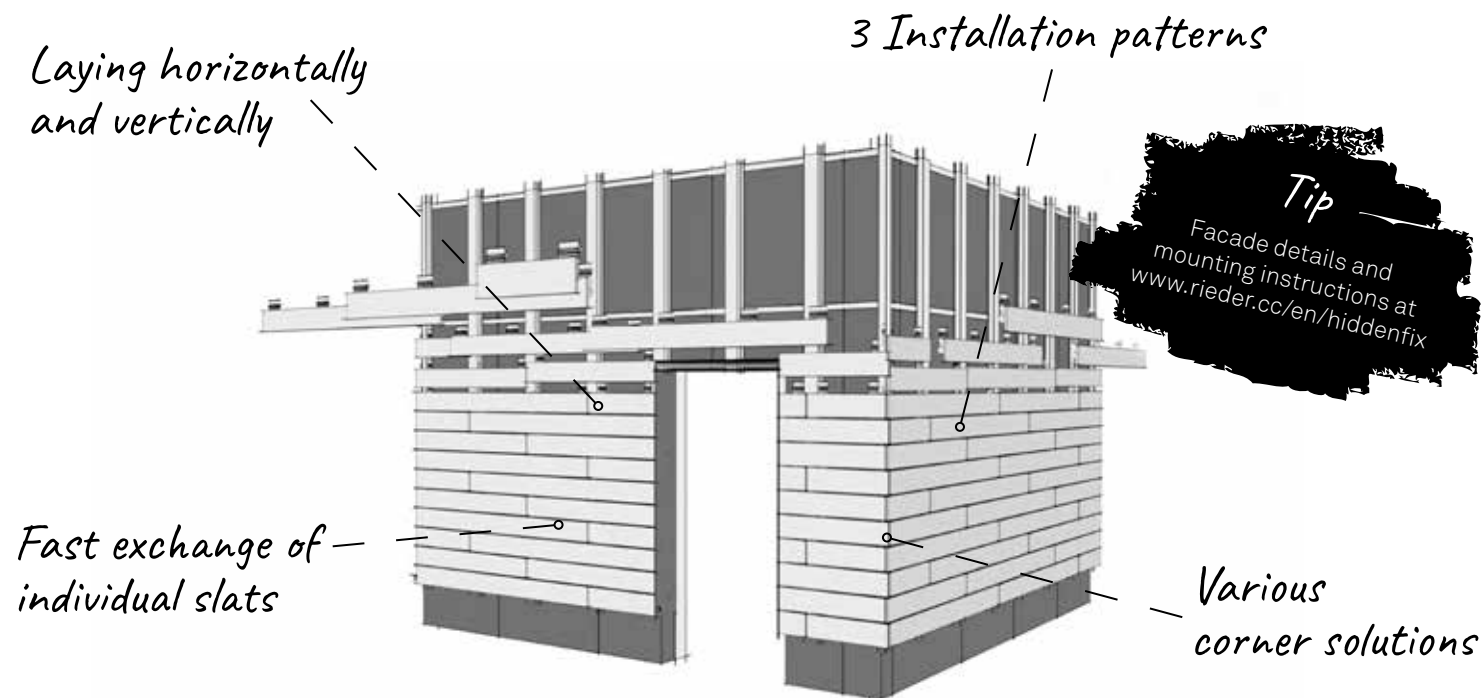

Special solution formparts

Rieder offers a library of standard details especially for the attachment of formparts. The R2R Library was created based on many years of project experience and offers a comprehensive collection of developed and implemented mounting solutions for a wide range of types of buildings and facades. The mounting and the substructure vary depending on the product characteristics.



Substructure parts for formparts must always be designed and calculated individually and project-related. Various solutions can result depending on the intended use, on the influences (loads) and taking into account the possible introduction into the shaped part.

03 Chapter

Services

Support of Building phase 56

Handling

Packaging 58
Transport 60
Receiving goods 61
Storage 62
Handling 63
Preparation assembly 64
Cutting 65
Drilling 66
Cleaning 67
Repair 68

Building



BayWa Tower, Munich, Germany | Hild and K Architects

concrete skin | sahara, sandstone | ferro

Project management & data preparation

- > Preparation of the plan for production including all cuts and drillings

Industrial manufacture

- > Generation of production data from 3D models
- > Digital data integration through computer-controlled processes
- > Shell construction and production of the facade elements

Drilling

- > On request, all necessary holes can be pre-drilled at the Rieder factory.

Production of element substructures

- > Production of the primary substructure as an optional service

Tip
Weather-independent and fast installation possible on site due to preparation in the Rieder factory

Cutting

- > Angled cuts
- > Mitre cuts
- > Cut-outs
- > Perforations
- > Pre-cuts
- > Machining the bevel

Preassembly

- > Preparation of installation drawings and instructions for each element type
- > Optional pre-assembly of the element substructure into the facade element in the factory or on site in the field, independent of weather conditions
- > Implementation of modular construction methods

Logistics concept & transport

- > Elaboration of the optimal assembly sequence taking into account the respective packaging unit
- > Track & trace: Bar and QR codes for clear identification of each component within the production process, the supply chain and at the construction site
- > The logistics or sorting sequence must be available to Rieder before the start of production.

Supervision & training

- > Worldwide consulting, training and construction site support
- > Hands-on training & factory visits
- > Construction site instructions from Rieder specialists

Sorting for the construction site

- > Pre-sorting of products according to facade side

Individual packaging for formparts

- > Safe storage and delivery in polystyrene forms (recyclable)
- > Individual packaging can be designed for special on-site assembly requirements.

Installation supervision

- > On-site instruction

Robust packaging is necessary to ensure the safe transport of the often complex elements in different shapes and sizes. The shapes vary depending on the project, so standardised packaging is not possible. Thanks to many years of experience and know-how, Rieder designs and manufactures packaging individually for each project.



Edge protector

Maximum safety during transport with factory-mounted edge protection.

Documents

The most important documents for delivery and further processing by the client are enclosed with each pallet.

Weather protection

Each pallet is protected from the weather during the loading process using a cover and foil. This protection is not sufficient for outdoor storage. Additional roofing is recommended.

Economical

Rieder attaches great importance to sustainable and economic solutions. The space-saving packaging is adapted to the length of the lorries. This means that fewer lorries can transport a larger quantity - thus conserving resources.

Individual

Each formparts project requires individual packaging for the shaped parts. These are designed in-house with a 3D program and then cut to size using a styrocutter.

Simple handling

The pallets are loaded in such a way that a onsite handling is kept to minimum and is as simple as possible.

Zero Waste considerations

If a project requires several deliveries, the Rieder products are packed and shipped on iron frames. The frames can be reused several times, the consumption of wooden pallets is minimised. In the case of large orders, the polystyrene packaging can also be returned so that it can be used for a new delivery.

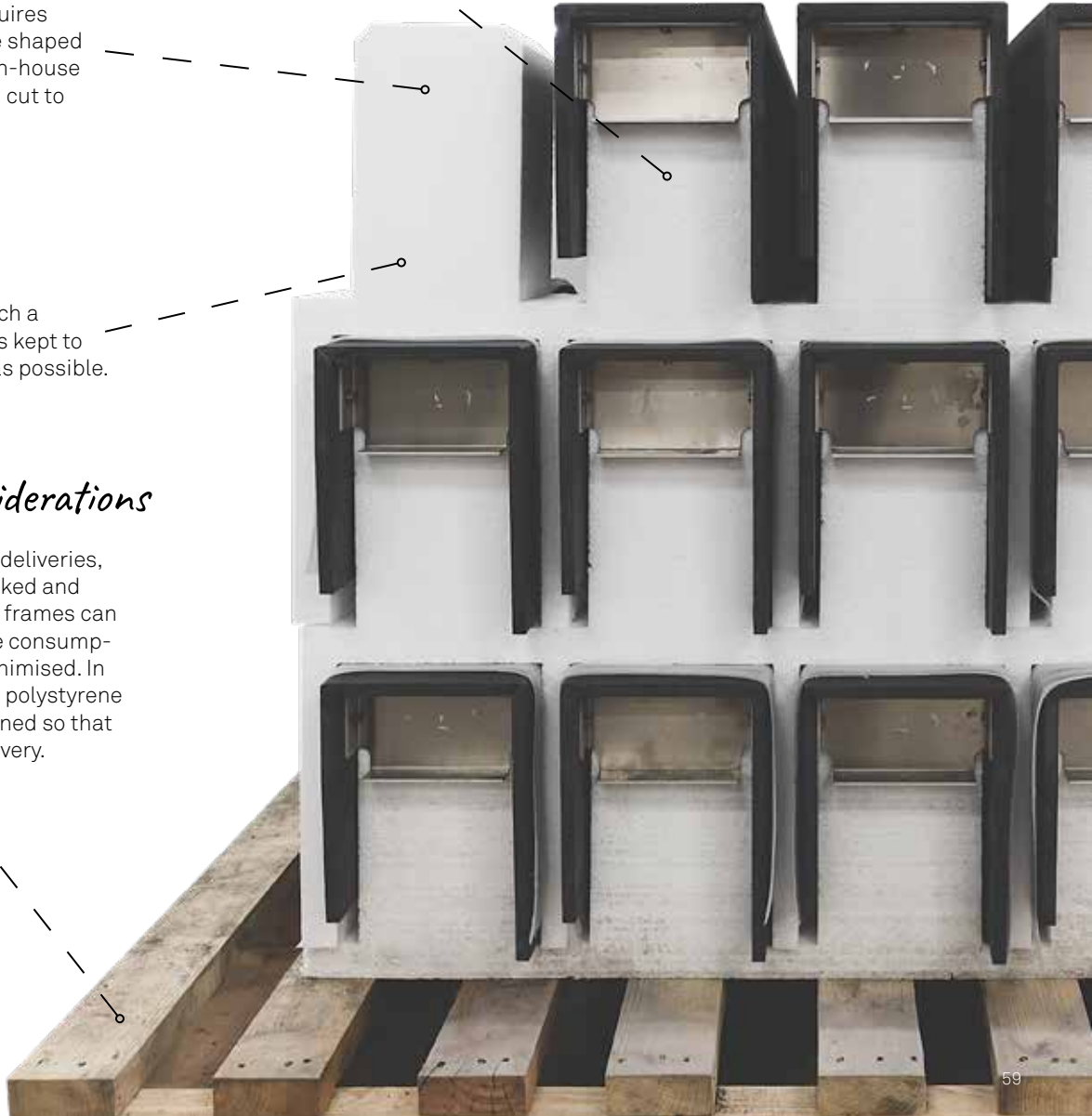

Loading

Positive, secure loading. Do not place larger pallets on smaller ones. Do not place other products on the pallets. Do not walk on the pallets. Transport safety is only guaranteed with sturdy edge protection. Number of securing straps according to the legal requirements of the respective country. The load must be secured. For container loading, please refer to the Container information sheet.

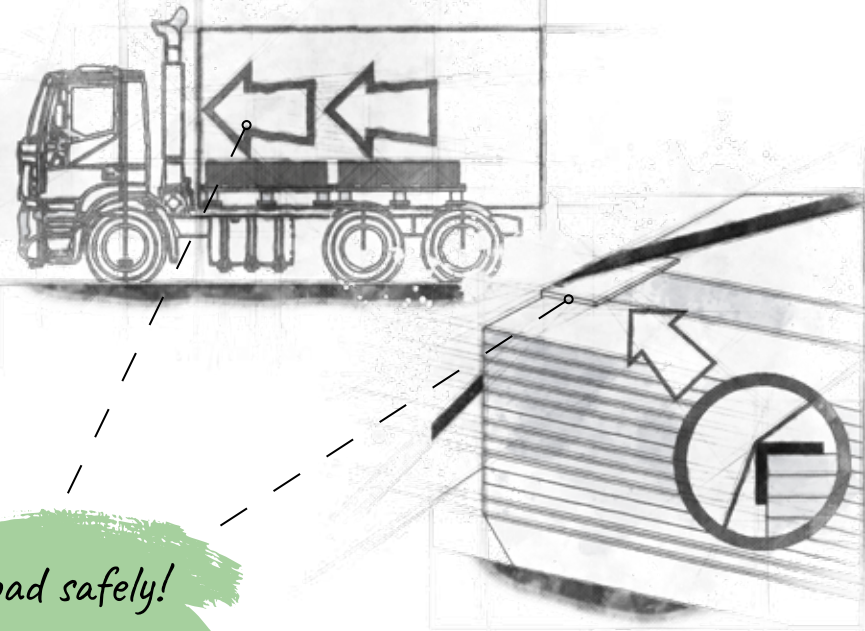

Load safely!

Unloading

Unloading exclusively with forklift and/or crane. Min. 2000 kg load capacity at maximum required outreach, 4 tines required, fork spacing min. 2300 mm, unloading traverse for crane unloading. If a forklift with 4 tines is not available, the pallet with the panels must be placed on a steel frame and only then can it be transported on site. Pallet sagging causes surface cracks and even strong panel damage. The correct distances of load support must be observed. Pallet vibration during manipulation must be avoided. Remove pallets individually - do not stack them on top of each other or place them on the edge of the lower pallet. The weight per pallet is usually between 1.5 and max. 2 tons. Drive slowly!

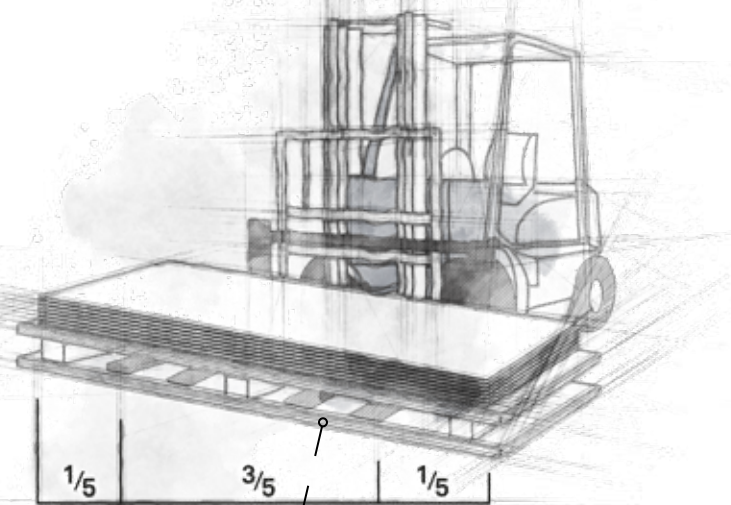

Ensure proper load distribution & avoid panel deflection!

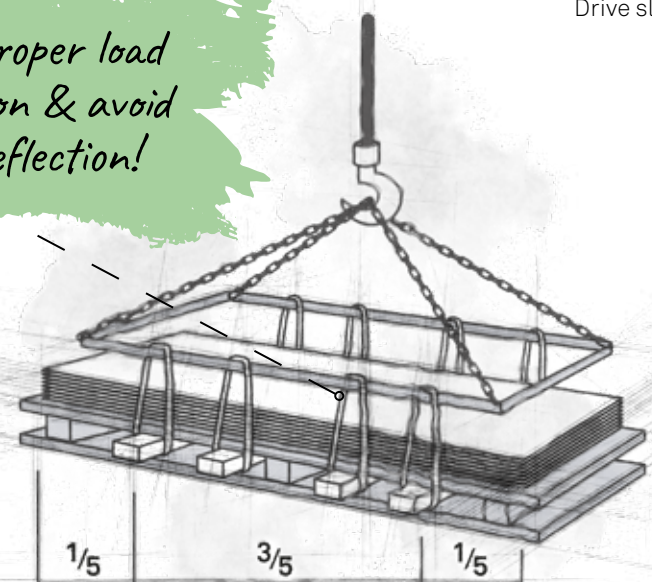

Briefing

All processors must be briefed before processing begins. The processing guidelines of the manufacturers of substructures and/or fasteners must be observed!

Documentation

Inspection on receipt of goods. Transport damage must be listed in the transport documents and countersigned by the driver.

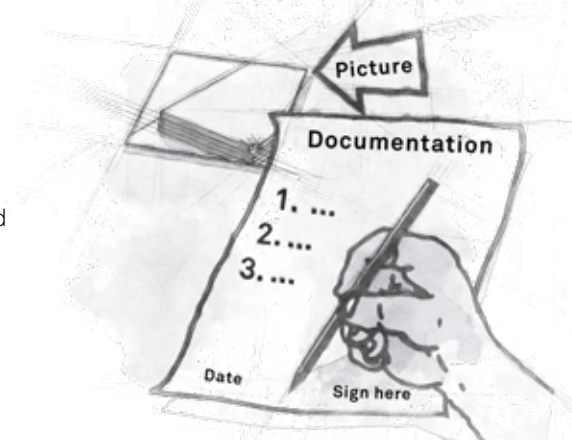

Keep documents

Handling guidelines, packing list and pallet labelling should not be disposed of.

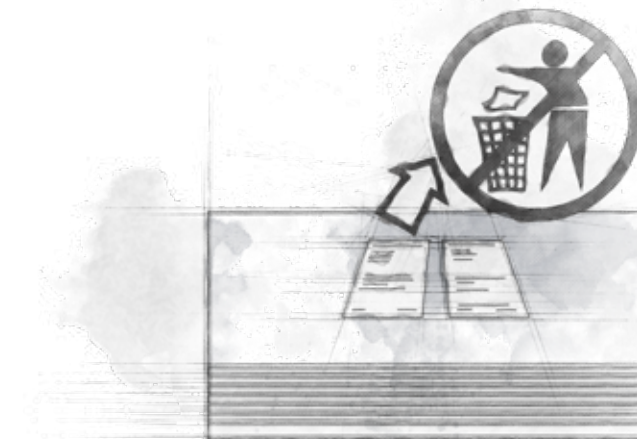

Document defects

Any defects on the panels must be documented with a photo (place a metre rule next to it for size comparison purposes), panel ID number and report, and must be reported immediately in writing (complaint). Safeguard defective goods. Do not mount!

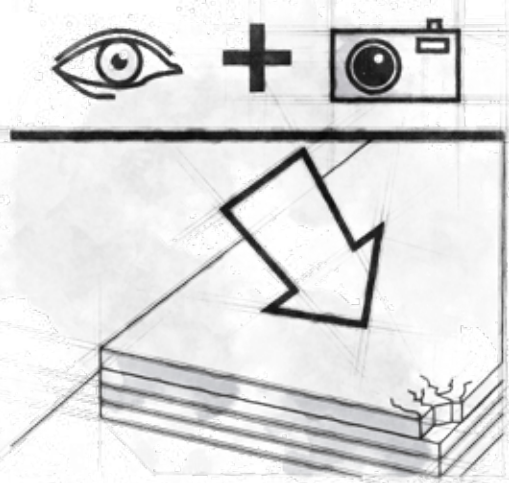

Storage location

Dry and level storage location. Rieder recommends that a suitable storage place for the products is found during the construction planning stage - especially for large projects - e.g. underground car park, hall etc. Ensure a level surface when putting down! Pallets may not be stacked at the construction site.

Store horizontally

Do not place larger pallets on smaller ones. Avoidance of sagging and vibration. Do not place the panels vertically or lean them against something.

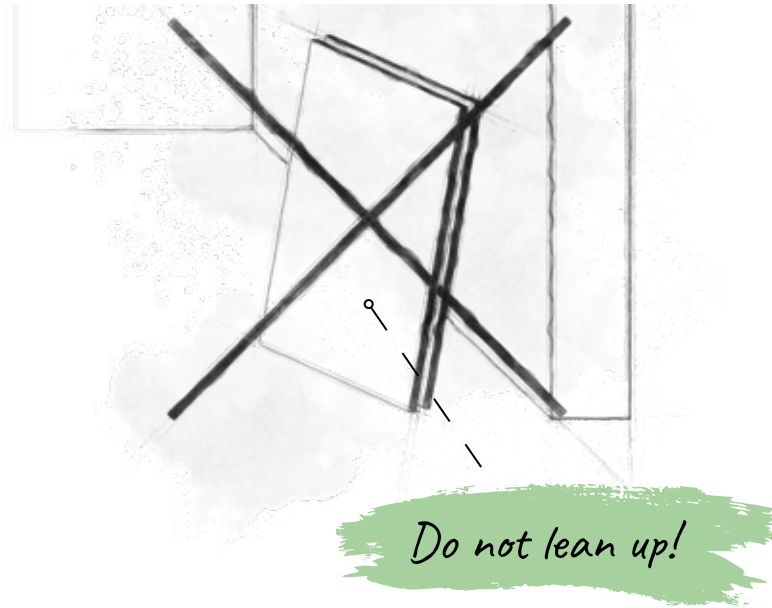

Stacking

Only use full-surface layer pads. No stacking on top of each other without sufficient protection between the individual panels. No glassfibre reinforced concrete elements, pieces of wood or other materials may be inserted between the panels. To protect against damage caused by the panels rubbing against each other, a poly-foam sheet must be placed as an intermediate layer on each panel.

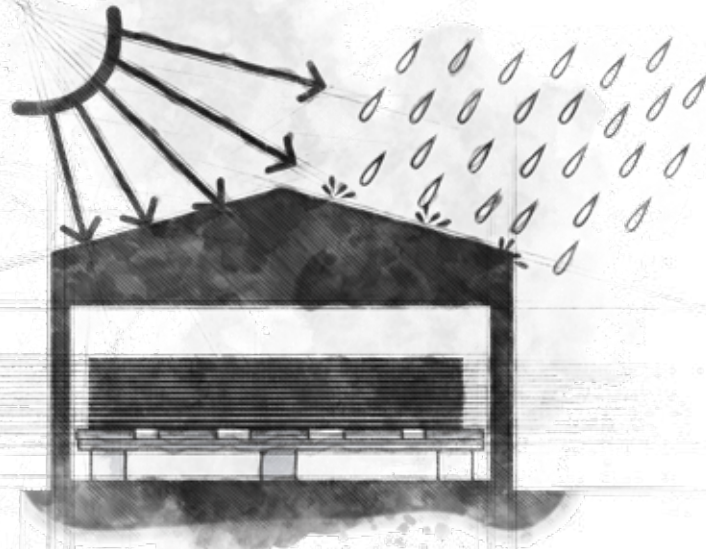

Protect from inclement weather

fibreC panels must be stored safely and well protected inside or under a roof until just before mounting on the facade. Suitable protection against moisture and direct sunlight must be ensured. The panels may only be removed from their packaging immediately before installation. For short-term outdoor storage, the pallet packaging must be opened to avoid condensation of moisture. The top panel must always remain protected until just before installation. In addition, the panels must be fully covered using suitable construction sheeting. fibreC packaging film does not provide sufficient weather protection.

Turning and flipping

Rotate the panels carefully

Do not push or pull panels from the stack. Always lift. Panels must not rub against each other.

Rotating the panel

Rotate the panel manually on the construction site using corner rotation protection. Place the corner protection over one corner of the panel and turn the panel vertically over the corner protection. Never rotate the panel while lying flat - danger of cracking!

Flipping the panel

Gently lift the panel from the pallet, place it vertically with its edge on the work surface and carefully turn and lay it down. Do not place boards on edges or corners without appropriate protection (e.g. polystyrene or carpet).

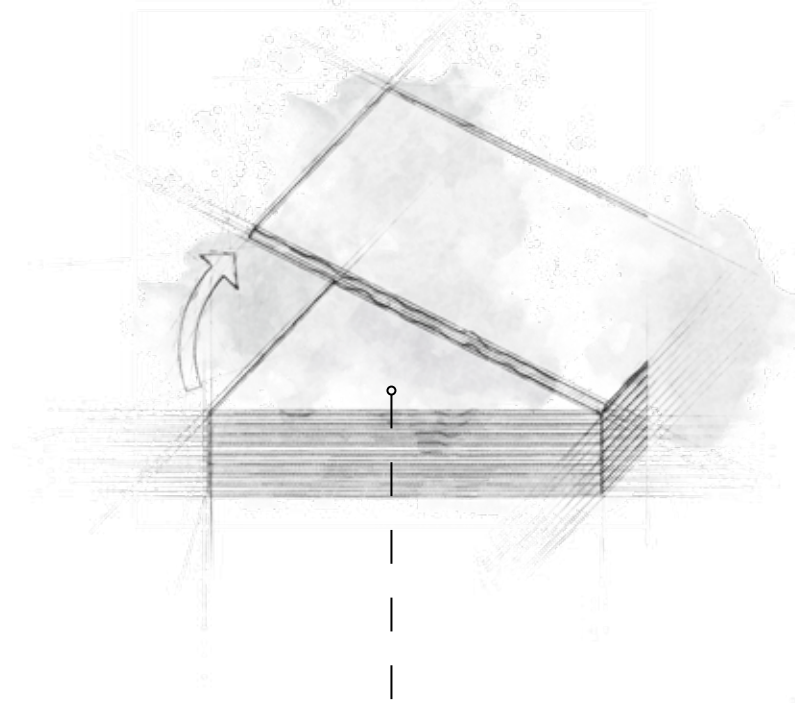

Pay attention to the correct handling during transport on site!

Carrying

Manually transport panel in upright position! Wear clean protective gloves and work protection gear. Caution: heavy. Danger of injury! Avoidance of sagging and vibration. Panel sagging causes surface cracks and even panel breakage. Treat narrow, long panels with special care! Do not stand panels on their edges or corners without appropriate protection (e.g. styrofoam or styrodur).

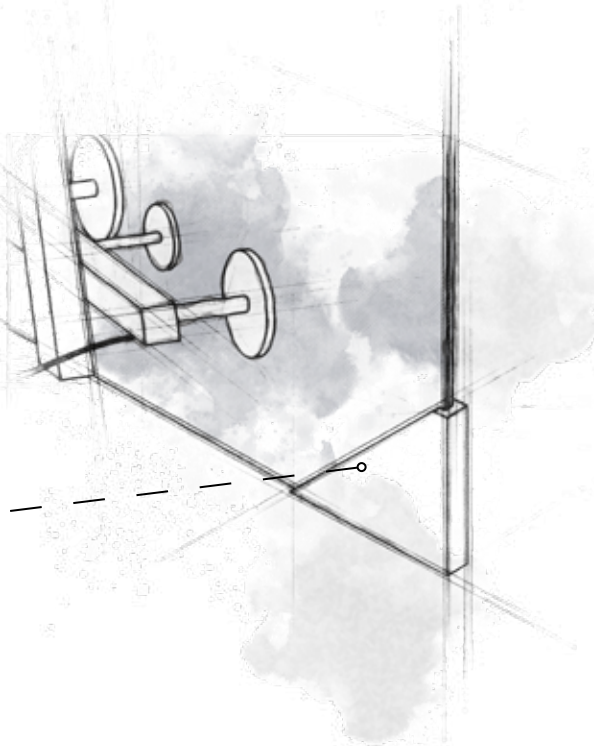
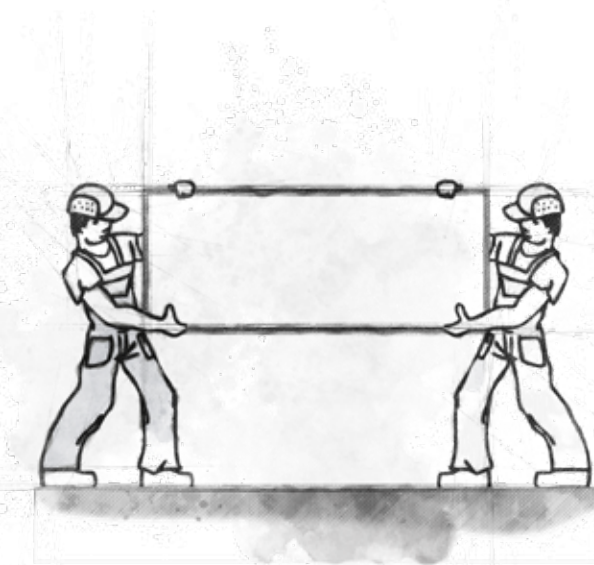

Generally, the panels are cut and pre-drilled at the Rieder factory. However, if treatment is to be carried out at the construction site, the following guidelines must be observed.

Equipment

Suitable technology is required for unloading, reloading, transport and assembly. Vacuum suction cups with permanent suction for lifting and mounting the panels as well as special swivelling suction cups for mounting behind the scaffolding must be used. Use silicone suction cups, as black rubber cups will leave marks on the panel. Depending on the application, use individually manufactured mounting frames as well as cable hoist or assembly crane with panel handles or claws.



Work surfaces

Create a suitable work surface (trestles with full-surface area support or work table). If it rains, make sure the working environment is dry.

Protection

Protective goggles and a fine dust mask must be worn for all drilling and cutting work. Clean white working gloves are recommended to avoid soiling.

Vacuum cleaner & compressor

Use a suction traverse on the worktable and a vacuum cleaner to suck up the sawdust and a compressor to blow off the remaining sawdust. Drilling and cutting dust must be completely removed immediately before it damages or contaminates the surface of the panels!

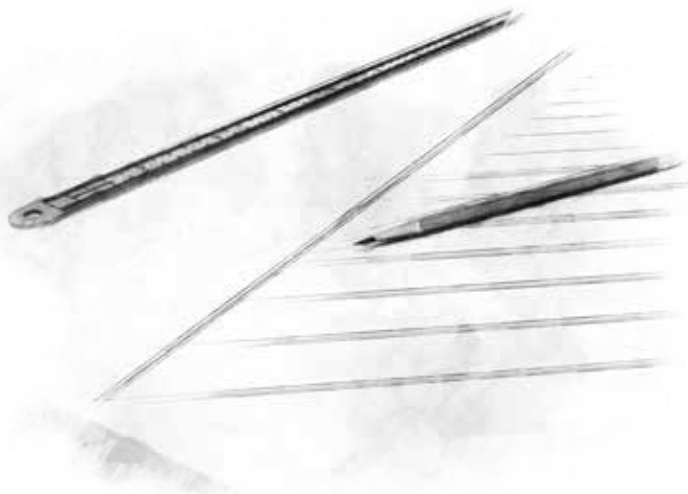

Markings

It may not be possible to remove markings. Therefore, only make cutting marks on parts of the panel to be cut off.



Wet cutting

fibreC panels can be cut to size using a water jet. This is particularly suitable for complex cuts such as curves and bevel cuts. After the wet cutting process, it is very important that the panels are cleaned with clean water and then dried. Under no circumstances may the panels be processed or stacked in a damp state. Incorrect handling of the panels in a wet condition can lead to a deterioration in quality.

Dry cutting

Precise matching cuts for cut-outs, bevel and mitre cuts with circular hand saw, guide rail and splinter protection. To avoid splintering or unclean cuts, the cut must always be made on the visible side of the panel. Diamond saw blade for circular hand saw. Cut data: speed approx. 6500 rpm at Ø 150 mm, feed approx. 2-3 m/min, cutting speed approx. 50-60 m/s. Use commercially available jigsaw with diamond tipped jigsaw blade for cut-outs. Rieder recommends a test cut on a waste piece to check the suitability of the tools used.

Cutting on site

On-site cutting can be done with a hand-held circular saw using a guide rail. The visible side of the panel faces upwards. fibreC products can also be cut with a circular table saw and a diamond saw blade.

Saw blade

For standard cuts Rieder recommends a lightly toothed diamond circular saw blade, Ø 150 mm, hole diameter 22.5 mm, compensation ring to 20 mm. For very fine cuts, e.g. mitres, a diamond circular saw blade with closed diamond facing is suitable or a diamond jigsaw blade. The cutting capacity with closed diamond facing is reduced by about 25%. On request, Rieder recommends selected manufacturers of saw blades.



Drilling

It is recommended to have the drilling work done by Rieder, as this is done in a suitable and protected environment, with the right tools and by trained personnel. In this case Rieder carries out the quality control checks and guarantees the correctness of the drill holes. The position of the drill holes in the panels must be specified by the processor by means of drilling coordinates in the "Rieder Order List" or by drawings in dxf format. If the drilling is done by a third party, no liability is assumed.

Through-hole

If drilling is necessary on site, masonry drills or special drills with Ø 8 mm must be used. Never use a hammer drill! Ensure that the drilling is carried out at 90° to the panel. To avoid splintering or unclean drilling, the through-hole must always be drilled on the visible side of the panel. Use a wooden or wood-based material underlay to prevent the back of the board from being ripped out. The through-holes will always be oversized (nominal Ø 8 mm) to allow for different thermal expansions between panels and substructure. The fixing point is established by means of a fixed point or sliding point sleeve at suitable points.

Drill markings

When cutting or drilling on the visible side, apply adhesive tape at the drilling point before marking and mark the mark on adhesive tape, as markings on the panel may not be removable.

Contamination

Drilling and cutting dust must be completely removed immediately to prevent damage to or contamination of the surface of the panels. Use the compressor to suck in the undercutting drill on the panel and to remove (blow off) the remaining cutting and drilling dust. Even drillings carried out by the customer must be subject to quality control checks, which must be carried out and recorded with the respective measuring calibrations or limit gauges in accordance with the approval or manufacturer's specifications.

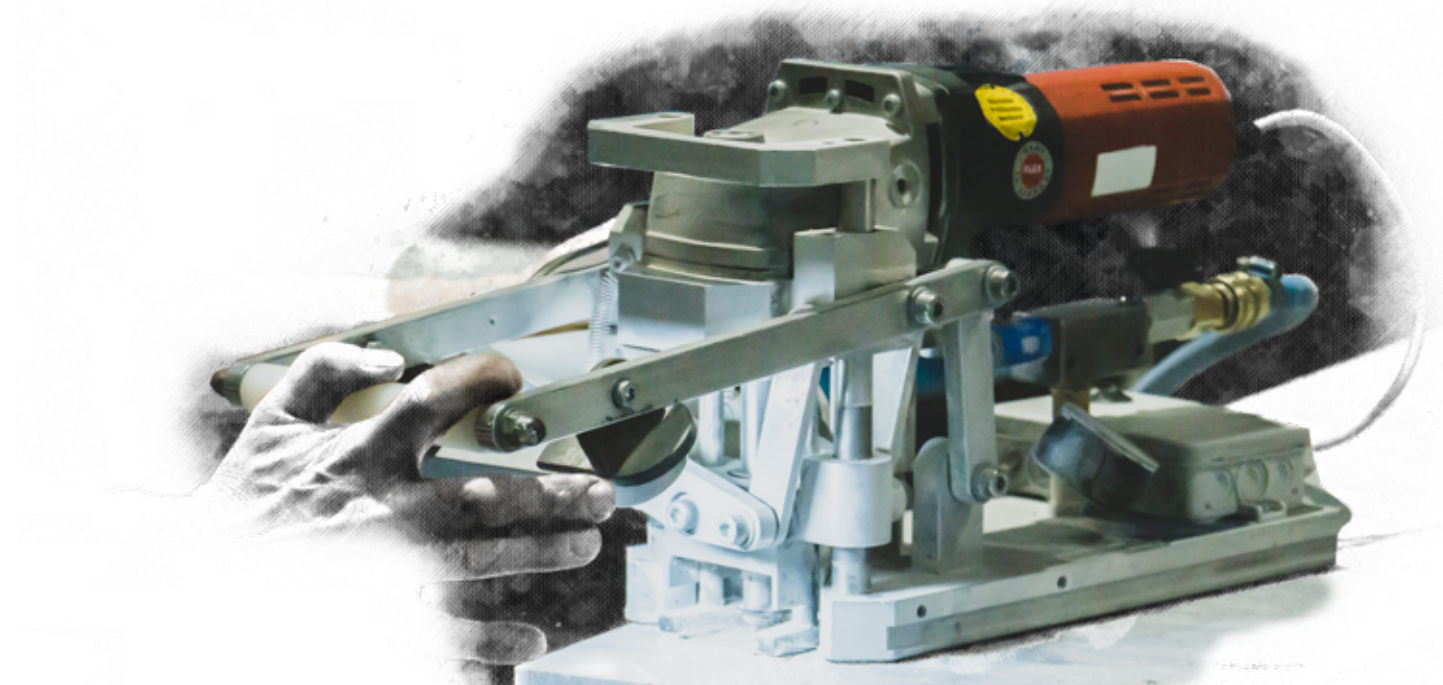

Cleaning the panels

Place the panel at an angle while cleaning. Clean under running water using non-scratch brush or microfibre cloth. Observe storage guidelines after drying. No water should remain on the panel.

Cleaning intervals after installation

Depending on the location of the building project and exposure of the facade to dirt, it is recommended that the facade be cleaned at intervals of 2 - 5 years by a specialist company. These cleaning intervals are recommended guidelines. Every facade should be inspected before cleaning to weigh up the necessity of cleaning.

Cleaning systems

For normal soiling Rieder recommends on request selected cleaning systems.

No chemicals

Do not use chemicals (except fibreC cleaner).

No high-pressure cleaners

Do not use steam jets or high-pressure cleaners. High-pressure water jets can leave streaks on the facade.

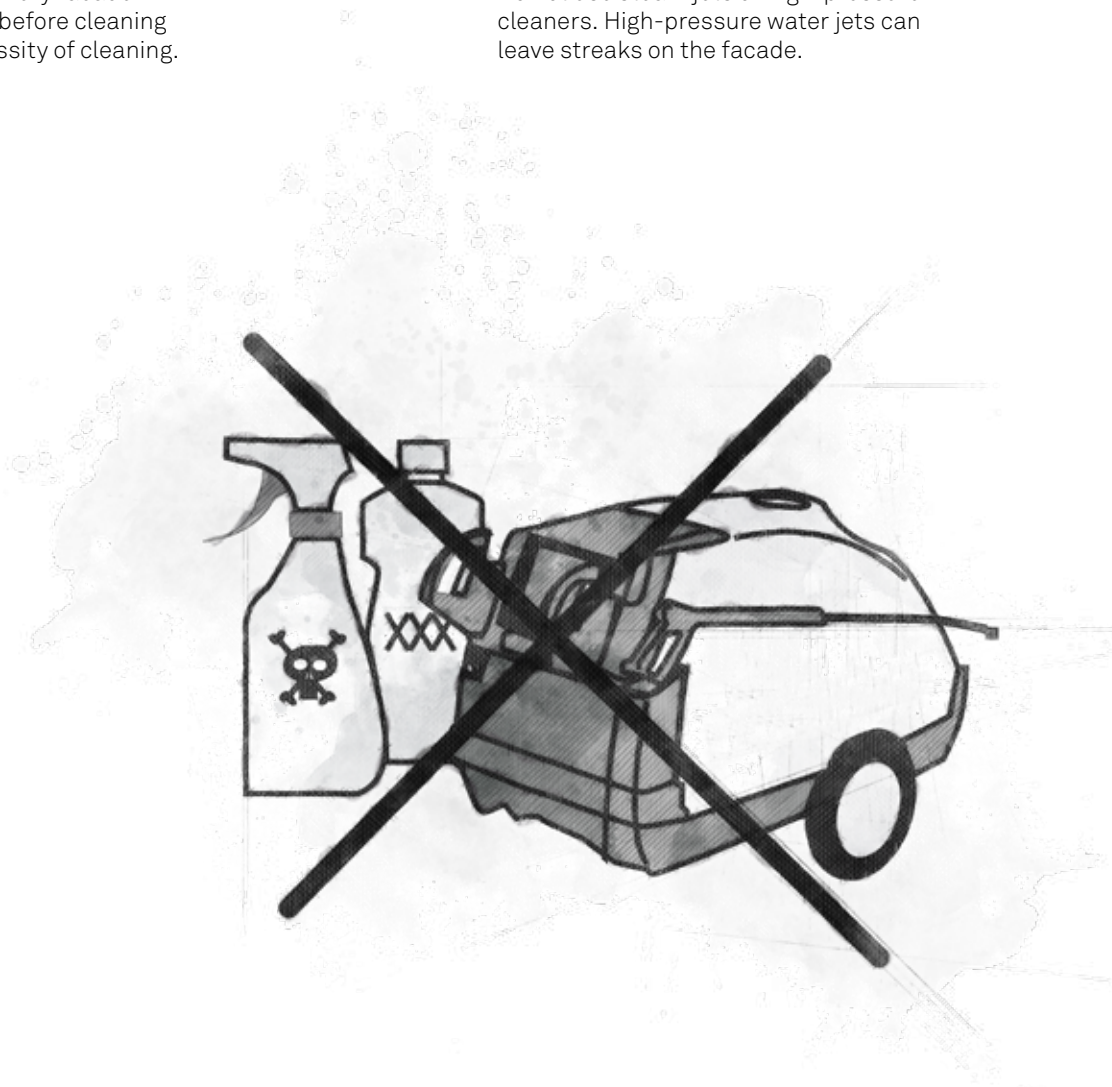

Incorrect usage can damage the coating due to its strong dissolving activity. In principle, the processing instructions of the cleaning systems must be observed. After completion of the installation work, Rieder recommends a general cleaning of the facade. Drilling and cutting dust must be completely removed when dry immediately (before installation) before it damages or contaminates the surface of the panels! Rieder assumes no liability for improper cleaning and maintenance.

For minor damage to fibreC products, such as edge chipping, flaking or other defects up to a size of 1 cm², the following work steps are recommended for the best possible repair.

Step 1 Filler compound

The first step is to fill up or fill in the damaged area. On request Rieder recommends selected filler compounds. The manufacturer's application guidelines must be observed. Rieder does not assume any guarantee in case of incorrect use.

Step 2 Coloured protective layer

Once the imperfection has been repaired with the filler and the appropriate drying time has been observed, the coloured protective layer must be applied with a suitable brush to conceal the colour of the filler. For each standard colour Rieder offers a suitably coloured protective layer.

The different surfaces of matt, ferro light and ferro can be produced by various means. The smooth matt panel surface is produced by simply applying the protective layer with a brush or foam rubber roller. To create the structure of the ferro light and ferro surfaces, the coloured protective layer should be lightly dabbed with a sponge after application.

Please note:

- > The surface to be treated must be clean, dry and dust-free.
- > Release agents, oils or other fluids can lead to adhesion problems.
- > The protective layer must be repeatedly stirred before and during application to prevent the components from settling.
- > The panel and ambient temperature must be at least 10 °C.
- > The protective layer should not be applied in direct sunlight.
- > Repeated application can lead to a shiny effect of the protective layer.
- > The requirement for protective coating mass per m² is approx. 130 g, density approx. 1.1 kg/l.
- > Immediately after use, clean the tools with warm water.
- > The bottled protective layer can be stored for 6 months in unopened containers under dry conditions.
- > Store the bottled protective layer in a cool and dry place, protected from frost.
- > Rieder does not assume any guarantee in case of incorrect use.
- > Treated areas may differ visually and in colour from the rest of the facade.

Filler compound suppliers

Rieder Sales GmbH
Mühlenweg 22, 5751 Maishofen, Austria
office@rieder.cc
www.rieder.cc

Protective layer suppliers

Rieder Sales GmbH
Mühlenweg 22, 5751 Maishofen, Austria
office@rieder.cc
www.rieder.cc



04 Chapter

Appendix

fibrec

Technical specifications	72
Norms and approvals	74
Perforation	76
Laying patterns for öko skin	77
Details formparts.fab	78
Details formparts.mono	79

Mounting

Details ventilated curtain wall facade	80
Details undercut anchor	84
Details Rieder Power Anchor	88
Details bonding	92
Details rivets	96
Details screws	99

General information

Notes	101
-------	-----

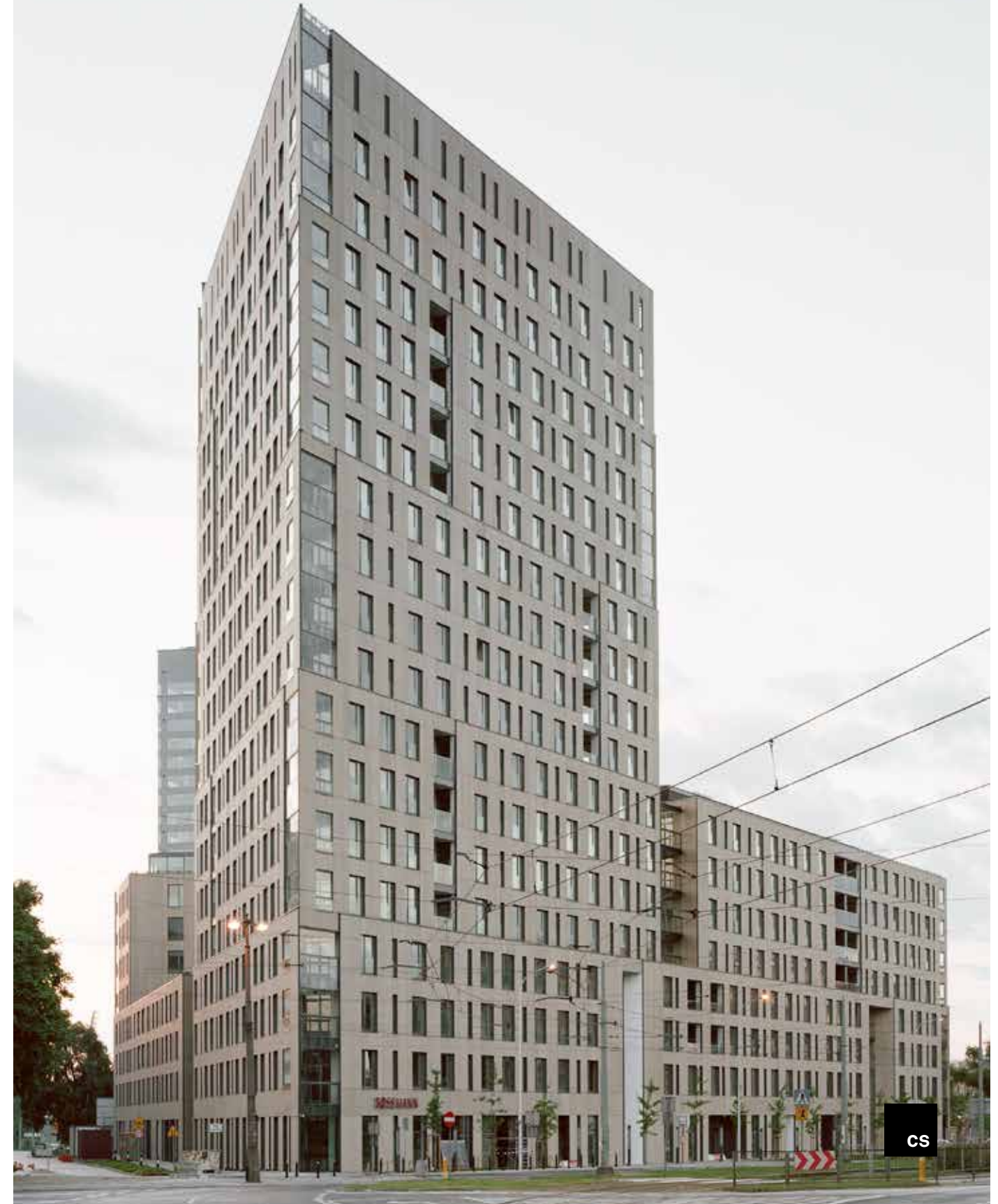

Trio Apartments, Warsaw, Poland | JEMS Architects

concrete skin | sandstone | ferro

Areas of application¹

- > Facade cladding with rear ventilation
- > Inclined facades
- > Weatherboarding
- > Outer planking of prefabricated composite elements
- > Cornice coverings
- > Cladding of window reveals
- > Cladding of window and door lintels
- > Fascia
- > Balcony cladding (with restrictions)
- > Base, pillar and column cladding (half-shells)
- > Solar protection elements
- > Roof coverings
- > Wall cladding
- > Interior wall cladding/room divider
- > Floor covering
- > Kitchens, furniture fronts
- > Work surfaces/bar toppings
- > Furniture
- > Verge and eaves ends
- > Portal construction

Formats

Characteristics	
Special formats	upon request
Dimensional deviation Length	± 1 mm/m
Dimensional deviation Width (1.2 m)	± 2 mm
Diagonal difference up to 1.5 m over 1.5 m	± 3.5 mm ± 4 mm
Diagonal difference up to 2.5 m over 3.6 m	± 5 mm ± 6 mm

Thickness

13 mm		
Thickness tolerance	± 10 %	EN 12467
Edge straightness (level 1)	± 0.1 %	EN 12467
Perpendicularity (level 1)	± 2 mm/m	EN 12467

Physical characteristics

Characteristics		
Flatness tolerances up to 0.6 1.2 2.4 3.6 m	± 2 mm ± 4 mm ± 6 mm ± 8 mm	
Raw density (13 mm)	2.0 - 2.42 kg/dm ³	EN 12467
Flexural strength ²	> 18 N/mm ²	EN 12467, class 4
Young's modulus for deformation calculation	approx. 10.000 N/mm ²	
Young's modulus for constraint calculation	approx. 30.000 N/mm ²	
Dead load/weight per unit area (13 mm)	26 - 31.5 kg/m ²	
Coefficient of thermal expansion	approx. 10 x 10 ⁻⁶ 1/K	DIN 51045
Classification of fire behaviour	A1 - non-combustible A2-s1,d0 - non-combustible	EN 13501-1
Temperature stability	depending on core moisture up to 350 °C	
Specific thermal capacity	approx. 1,000 joules/(kg*K)	
Thermal conductivity	lambda: approx. 2.0 W/(m*K)	
Humidity expansion	0.05 %	EN 12467

Weather resistance

Characteristics		
Impermeable to	water	EN 12467
Heat/rain cycle test	given	EN 12467
Frost resistance	given	EN 12467
Freeze-thaw cycle test	given	EN 12467
UV light resistance	UV-resistant colour pigments	DIN 12878
Wet-storage resistance	given; efflorescence may occur	EN 12467
Hot water resistance	given	EN 12467

Mounting

Characteristics	
Visible mounting	rivets, screws
Concealed mounting	bonding, undercut anchor, Rieder Power Anchor
Substructure	aluminium, steel
Joint width	at least 8 mm recommended; The maximum joint width depends on the respective applicable national regulation.

Further specifications

Characteristics	
Reinforcement	through glassfibre textile fabric approved by the building authorities
Edge formation	cutting edges are unfinished and sharp-edged with a roughness of approx. 1 mm on the visible side. Glassfibres may protrude at the edges. The rear side may have recesses
Colours ³	solid colouring of the entire panel; 23 standard colours; special colours on request
Surfaces ³	matt: matt or brushed surface ferro light: lightly blasted surface ferro: blasted surface
Surface protection	protection against environmental and weather influences

1) If fibreC products are installed as an alternative, specific regulations must be observed for the respective application. More detailed information on the respective area of application is available on request. It should be noted that certain applications, such as roofing or bar topping, may result in greater discoloration and soiling, as the protective layer is subject to greater wear on sloping or horizontal surfaces.

2) MOR (Modulus of rupture): Design values deviate from MOR according to national regulations. The national certifications and regulations for calculating the rated resistance apply.

3) Due to the natural product concrete, every glassfibre reinforced concrete panel is regarded as a unique piece. Differences in colour, structure and texture are characteristic. Efflorescence or small visible pores are not defects. Light resistance varies depending on the colour. Differences in the surface appearance, which do not affect the serviceability of the panels, are permissible. 02/2004 Leaflet on exposed concrete EN 12467 [publisher: BDZ/DBV].

Subject to the respective offer documents. The description of the product characteristics must not be interpreted as a contractual obligation on the part of the manufacturer. No liability is assumed for the correctness, completeness and topicality despite careful scrutiny. This also applies in particular to printing errors and subsequent changes to technical specifications. Values are valid for purpose-specific installation of the facade.

Rieder is certified according to ISO 9001 and ISO 14001. All products are subjected to multi-stage testing according to international standards in order to ensure consistently high quality. Relevant certificates or confirmations regarding approval conformity can be provided on request.

Product and system approval

Area	Standard/approval
EU	General Technical approval I DIBT Z-31.1-212 I fibreC bionics
EU	European Technical Approval I DIBT ETA-06/0220 I fibreC glassfibre reinforced concrete panel with KEIL undercut anchor
US	ICC-ES Evaluation Report ESR-2810
UK	BBA Technical Approvals for Construction Certificate 16/5362
FR	Avis Technique I CSTB 682-100-99 I fibreC glassfibre reinforced concrete panels with rivet and bolt
FR	Avis Technique I CSTB 683-100-107 I fibreC glassfibre reinforced concrete panels with rivet and bolt
DE	General Building approval I DIBT Z-10.8-408 I fibreC glassfibre reinforced concrete panel with Sika Tack-Panel bonding system
DE	General Building approval I DIBT Z-10.8-483 I (restriction to grey cement) fibreC glassfibre reinforced concrete panel with Innotec Project System
DE	General Technical approval I DIBT Z-31.4-166 I fibreC glassfibre reinforced concrete panels with Rieder Power Anchor and rivets

Technical testing

Area	Standard/approval
EU	Earthquake proof in combination with the Sika Tack-Panel bonding system
EU	Freeze-thaw resistance based on CDF process
US	ASTM E136 & ASTM E84
US	Wind load test ASTM E330
US	Weather resistance test ASTM 1186
CA	CAN/ULC-S114
RUS	GOST Report number: KT-03-2010
AUS	Fire behaviour classification according to AS 1530.1:1994 ISO 1182:2010
DE	Fire behaviour classification according to DIN 4102
DE	Fire behaviour classification according to EN 13501-1
DE	Ball throwing test according to DIN 18032-3:1997-04
AT	Fire behaviour test according to ÖNORM B 3800-5
AT	Durability test in the wake of ETA 06-0220
AT	Heat/rain cycle test according to EN 12467
AT	Hail test (Hard Body Impact Test) according to DIN 18516-1 DIN EN 13583 ASTM E822 EOTA TR 001

Environment and quality

Area	Standard/approval
INT	DIN EN ISO 14001:2015
INT	DIN EN ISO 9001:2015
EU	IBO Certificate Institute for Building Biology and Ecology
US/CA	EPD Environmental Product Declaration I IBU Building and Environment
US/CA	LEED v4 Product information (Leadership in Energy and Environmental Design)
DE	Member of DGNB German Sustainable Building Council
DE	Member of IBU Institute Building and Environment

Relevant standards

Area	Standard/approval
EU	DIN EN 12467 DIN 18516-1 DIN EN 1186 DIN EN 13130 CEN/TS 14234

CE conformity

Area	Standard/approval
EU	Declaration of performance according to DIN EN 12467

Material	
Panel size	up to 5000 x 1500 mm (length: 7000 mm on request)
Panel thickness	13 mm
Surface	matt, ferro light, ferro, solo (only interior)
Reverse side (not visible side)	untreated or ferro
Colour collection	greyscale, timber, bricky, pietra, green
Textures	upon request

Perforation	
Perforation form	any shape or form
Percentage of holes	max. 30 % (clarification of the overall statics)
Hole diameter	at least 6 mm
Perforation angle	45° to 90°
Cut width	at least 1.5 mm
Distance between perforations	to be checked individually (depending on perforation size, shape and proportion of holes)

Handling	
Panel mounting	manual or with vacuum suction cups (depending on perforation), handling of the panel with special care depending on the percentage of holes, transport protection necessary

Mounting	
Visible (rivets, screws)	distance to panel edge min. 30 mm, corner: 30/100
Concealed (undercut anchor)	distance to panel edge min. 60 mm, horizontal min. 60 mm, additional substructure or bracing required depending on statics
Concealed (Rieder Power Anchor)	distance to panel edge horizontal min. 100 mm, vertical min. 30 mm, additional substructure or bracing required depending on statics
A project-specific check is always necessary. These include areas of system statics, technical feasibility, hole proportion or hole distribution, climbing protection, fall protection, burglary protection, mounting options and handling.	

öko skin slats can be installed on the facade, either as a single type or combined with different formats. The type of lathing depends on the desired installation pattern for the öko skin facade. They can be mounted horizontally or vertically. The choice of mounting pattern (straight, 1/2 or 1/3 staggered) influences the complexity of installation and substructure. For öko skin with a width of 302 mm, it is also possible to fix it as weatherboarding, where the slats overlap and are fixed to the supporting slats. Country-specific regulations regarding mounting and installation must be observed.

Laying horizontally

The dimensions given are valid for the standard format 1800 x 147 mm. For other formats of öko skin slats, the spacing of the supporting slats must be adjusted according to the project-specific specifications.

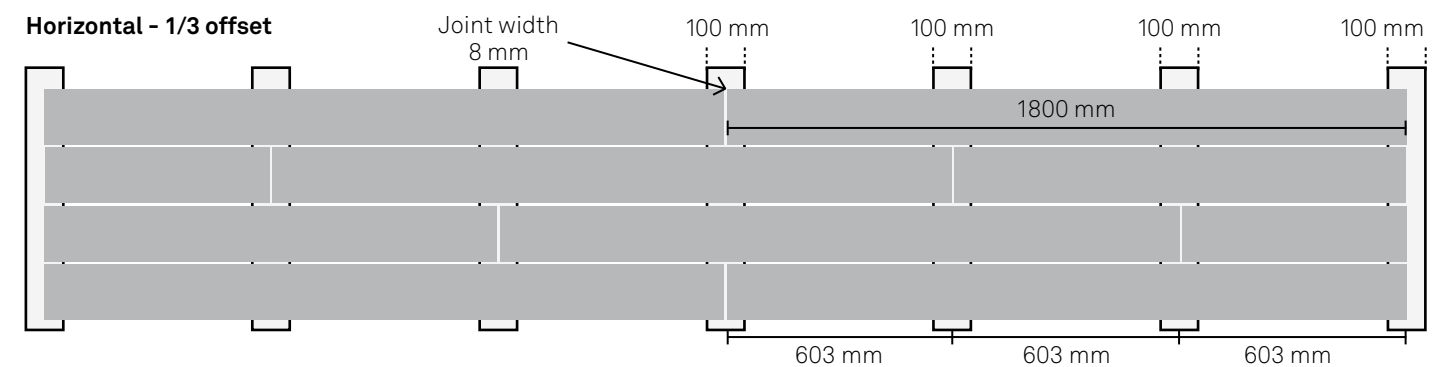
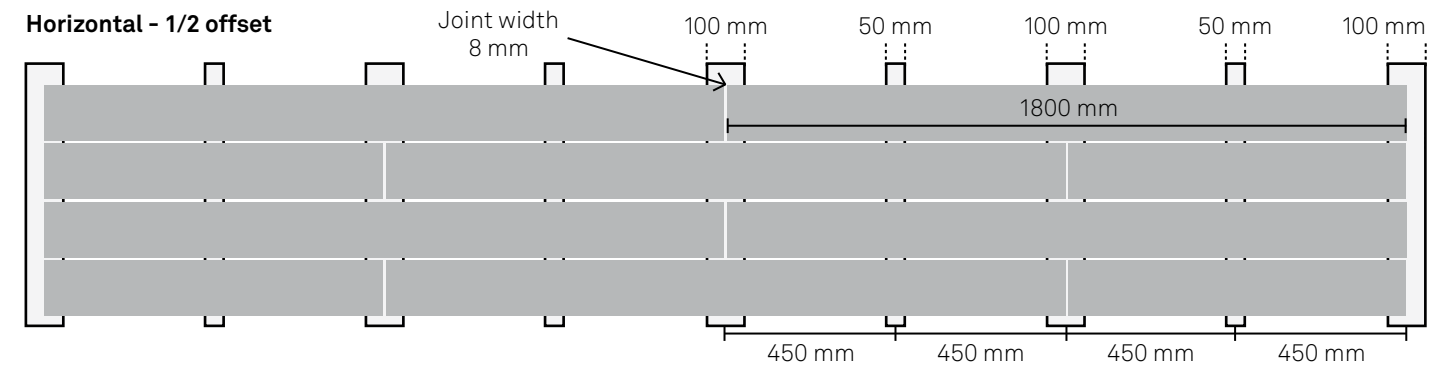
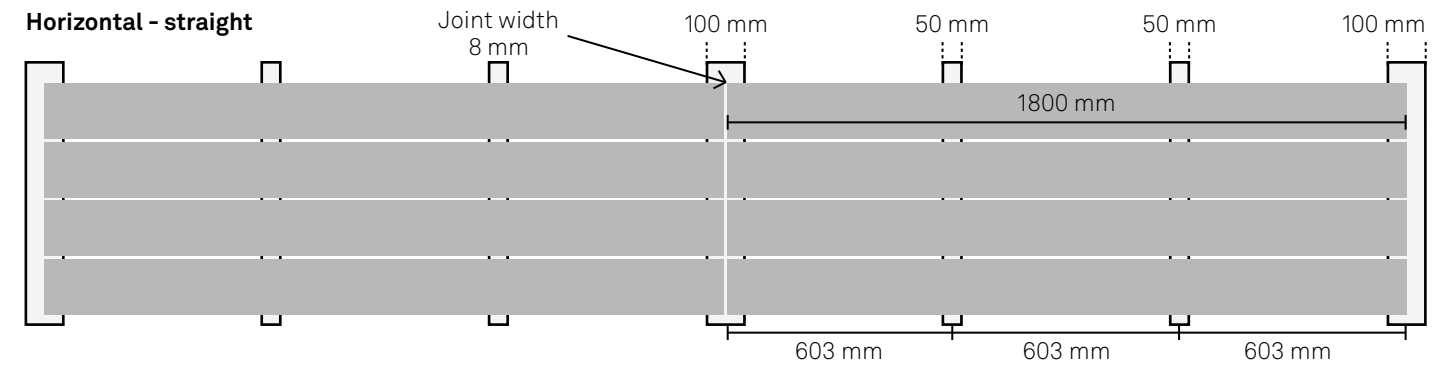

Laying vertically

For vertical installation, the substructure is rotated by 90°. The cap profile is thus fastened horizontally.

Technical specifications

- > For formparts.fab, approval may be required on a case-by-case basis.
- > With formparts.fab with a thickness of ± 13 mm, irregular edges may occur due to the surface.
- > The individual panels of formparts.fab must always be connected with corbels or brackets, and must be equipped with connecting elements to the substructure (already during production for handling, depending on size).
- > Examples of connecting elements to the substructure from the R2R Library can be sent on request.
- > The load transfer on the building by means of substructure or consoles must be guaranteed and coordinated depending on the project.
- > The position of the fixing points must always be clarified on a project-specific basis.
- > When designing the shapes and sizes, careful attention must always be paid to proper handling due to the fragility of the product.
- > Tolerances according to EN 12467

Area	Possibility
Surfaces	matt, ferro light, ferro
Textures	standard, travertine, groove, terrazzo black, twine, salt'n'pepper, vintage, luce silver, slate
Chamfer	2 mm \pm 1 mm
Visible mounting	rivets, screws
Concealed mounting	undercut anchor, Rieder Power Anchor, bonding

U-shape

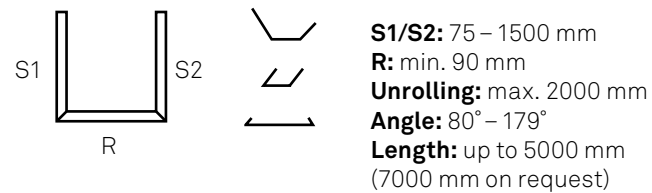

L-shape

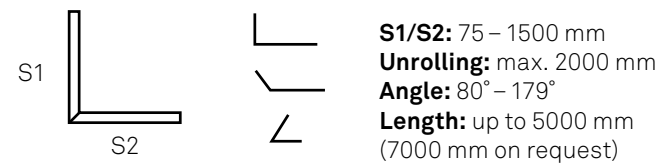

Special shape



fins

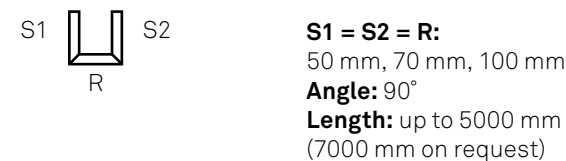

Technical specifications

- > For formparts.mono, approval may be required on a case-by-case basis.
- > The appearance of blasted surfaces (ferro, ferro light) can differ from other products at formparts.mono because all parts are blasted manually.
- > formparts.mono must be provided with connecting elements to the substructure (for handling, depending on the size, already at the factory).
- > Examples of connecting elements to the substructure from the R2R Library can be sent on request.
- > The load transfer on the building by means of substructure or consoles must be guaranteed and coordinated depending on the project.
- > The position of the fixing points must always be clarified on a project-specific basis.
- > When designing the shapes and sizes, careful attention must always be paid to proper handling due to the fragility of the product.
- > Tolerances according to EN 12467

Area	Possibility
Surfaces	ferro light, ferro
Textures	standard
Edge radius	standard: 3-15 mm optional: small (3-9 mm), medium (10-15 mm), large (> 15 mm)
Visible mounting	rivets, screws
Concealed mounting	undercut anchor, Rieder Power Anchor, bonding

U-shape

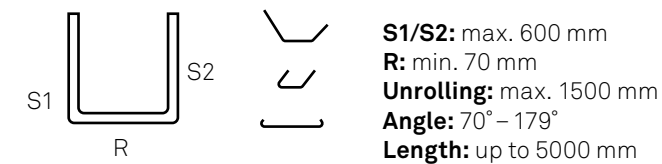

L-shape

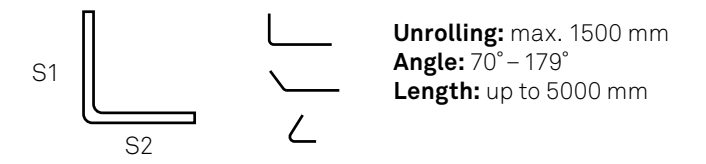

C-shape

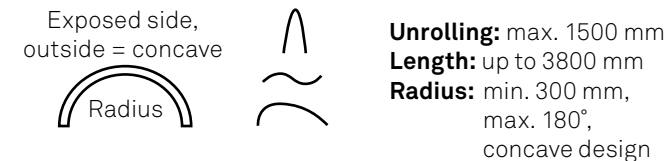

Special shape

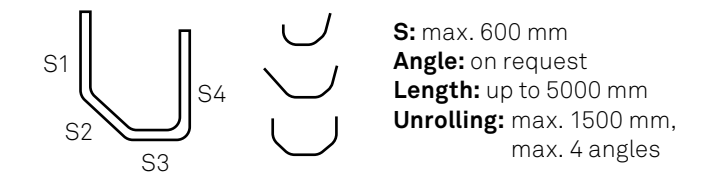

fins

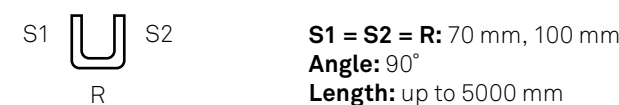

General Information

Rieder facade cladding is conceptualised as a mounted, ventilated facade in accordance with DIN 18516-1. To ensure sufficient rear ventilation of the complete system, adequate air circulation behind the cladding must be provided. The rear-ventilation distance depends on the permissible standard. Deviating standards outside the scope of the DIN must be applied accordingly. The panels must be mounted on a flexurally rigid, stable and level substructure that has been statically dimensioned. No forces or strains may be transferred from the substructure to the panels. All instructions of the substructure manufacturer must be observed. The number and distribution of fixing points for the facade panels depend on the respective building project. All dimensions given in this

brochure are recommendations by Rieder and may deviate from the standard.

Any liability for the substructure is excluded. The specifications of the substructure manufacturer must be taken into account for the detailed planning of the substructure. The possible mounting methods depend on the respective construction project. Responsibility for the mounting systems lies with the respective manufacturers. All illustrations shown in the brochure are schematic representations of the system. Building physics regulations and project-related details are not taken into account in the data.

Installation

Fixed and sliding points

The panels are to be fixed using one fixed and several sliding points. The fixed points must be provided on site during installation using a fixed- point sleeve. See approval

Z-31.4-166/item 2.2.4, 2.2.5 and ETA-06/0220. It makes sense that the fixed point on each panel is always selected at the same corner (e.g. top left).

Mounting and edge distances

Type of mounting	Drill hole spacing		Corner	Mounting distance (eH, eV)
	horizontal (a _{rx})	vertical (a _{ry})		
Undercut anchor	≥ 60 mm	≥ 60 mm	-	≤ 600 mm
Rieder Power Anchor	≥ 100 mm	≥ 30 mm	-	≤ 600 mm
Rivets	≥ 30 mm	≥ 30 mm	≥ 30/100 mm	≤ 600 mm
Screws	≥ 30 mm	≥ 30 mm	≥ 30/100 mm	≤ 600 mm

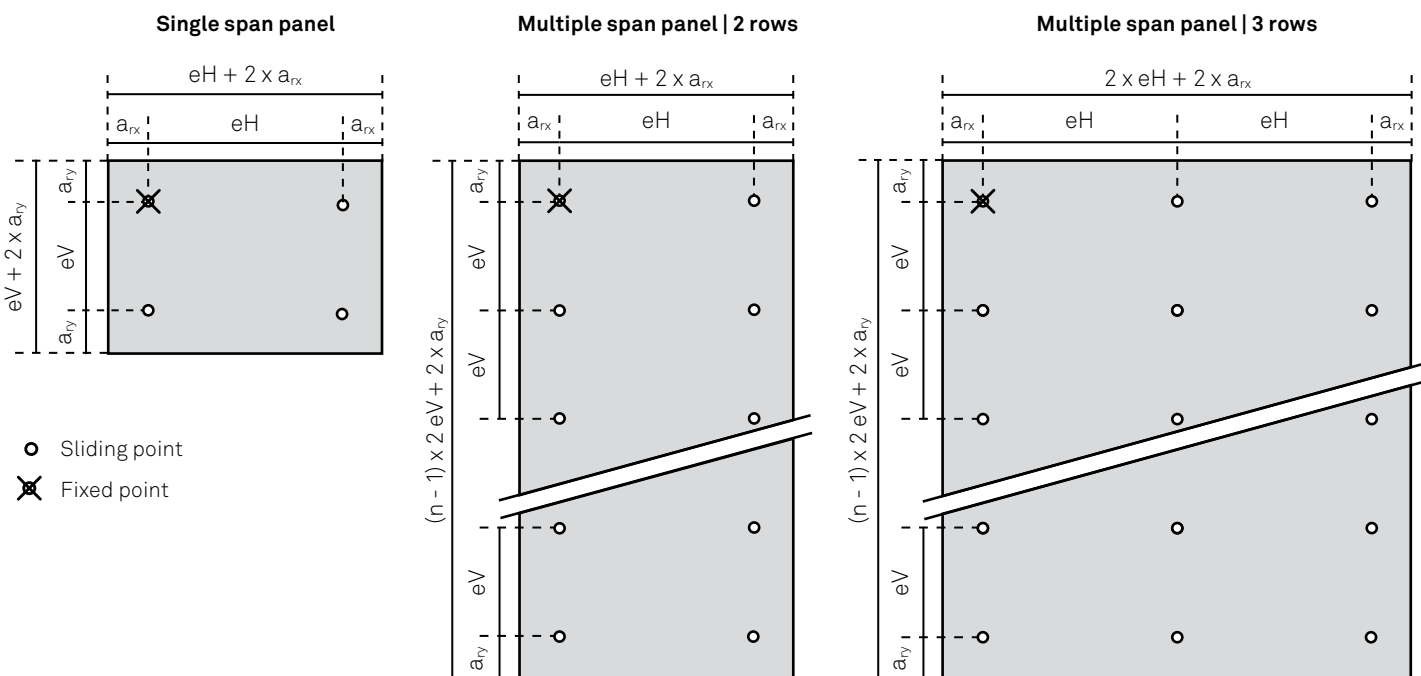

The positional accuracy tolerance of drill holes is ± 1 mm. These are always measured from the fixed point of the panel corner.

Load-bearing brickwork

The stability of the structure must be verified by a static calculation.

Substructure

The substructure must be made of metal (console). The aluminium or steel substructure is a flexible system that meets the requirements of the building regulations for a non-combustible facade construction. Any desired thickness of thermal insulation can be used with this substructure. It also easily compensates for construction tolerances. Basically, the installation of fibreC facade panels (for small area facades) and öko skin is also possible on a wooden substructure. This application must be checked and statically calculated in each individual case. Depending on the fixing method, the substructure can be aligned horizontally (e.g. agraffe-mounting) or vertically (e.g. riveting or bonding).

Decoupling

The substructure must be decoupled in accordance with DIN 18516-1 or with manufacturer specifications.

Thermal insulation

Dimensionally stable, hydrophobic mineral fibre facade insulation boards of flammability class A must be used. The panel joints must be designed as a tight press joint. The insulation must be fastened according to the manufacturer's instructions, but must be so stable that it is not possible for the panels to become detached and thus block the rear-ventilation cross section. It is recommended to use fleece-laminated insulation or a separate facade fleece in black.

Rear ventilation

The vertical rear-ventilation cross-section between the facade and the insulation must be at least $200 \text{ cm}^2/\text{m}$ and at least $50 \text{ cm}^2/\text{m}$ on the upper and lower sides of the facade. This, in combination with a distance of 20 mm between the insulation and the facade, ensures sufficient rear ventilation in accordance with DIN 18516-1.

Wind loading

Wind loads must be taken into account when determining the fixing and the spacing of the substructure. In the case of wind pressure/wind suction, a distinction must be made between the normal and edge areas of the facades. The relevant standards must be observed.

Fire safety

The fire protection requirements for the rear-ventilated facade depend on local regulations and must be adapted and taken into account accordingly. As a rule, horizontal fire barriers are used for ventilated facades, starting at defined building heights. Vertical fire barriers are also required under certain circumstances. The local regulations regarding fire protection must be taken into account accordingly by the installer.

Installing direction

Rieder products can be installed according to the design of the architect/designer. In the case of different installation directions, in order to simplify the installation or replacement of individual panels, it is important to ensure that the fixed and sliding points are always in the same position. The position of these points should be documented. If products are installed with a structurally predetermined direction of installation, the design template of the installation direction must be observed in order to ensure the desired appearance.

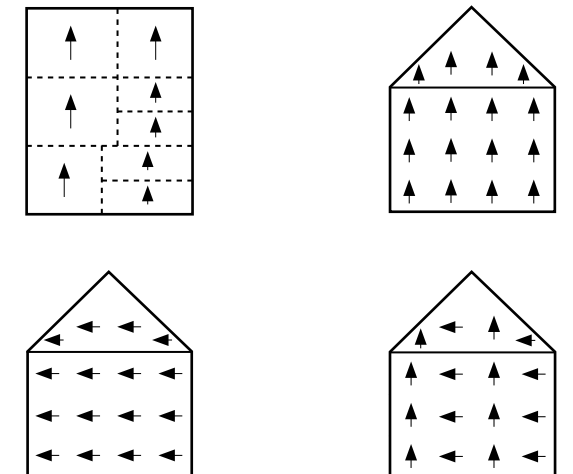

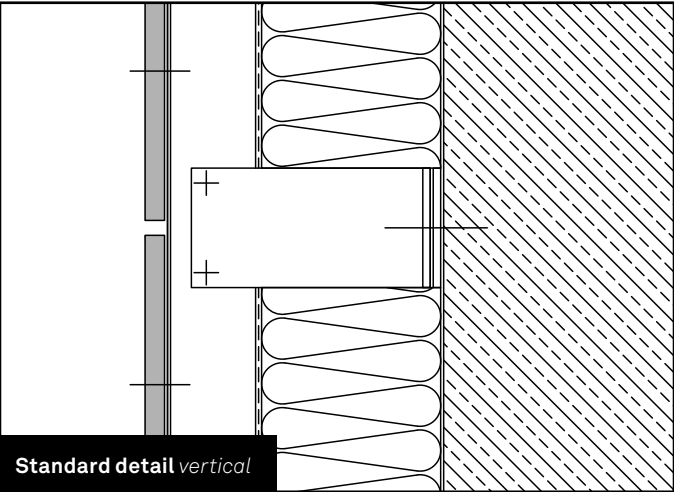

Standard detail *vertical*

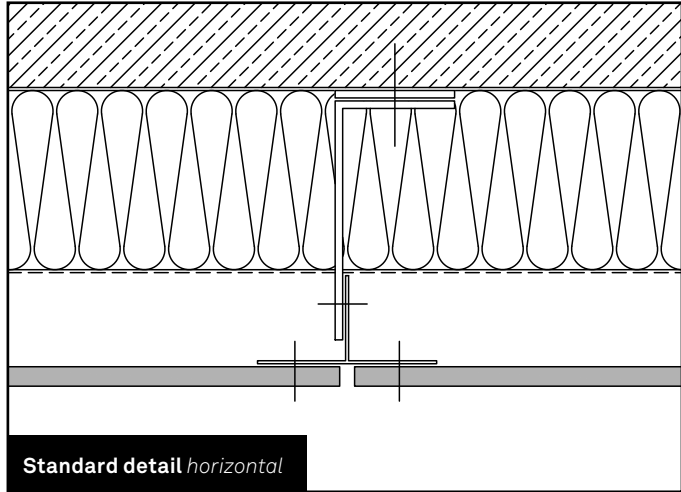

Standard detail *horizontal*

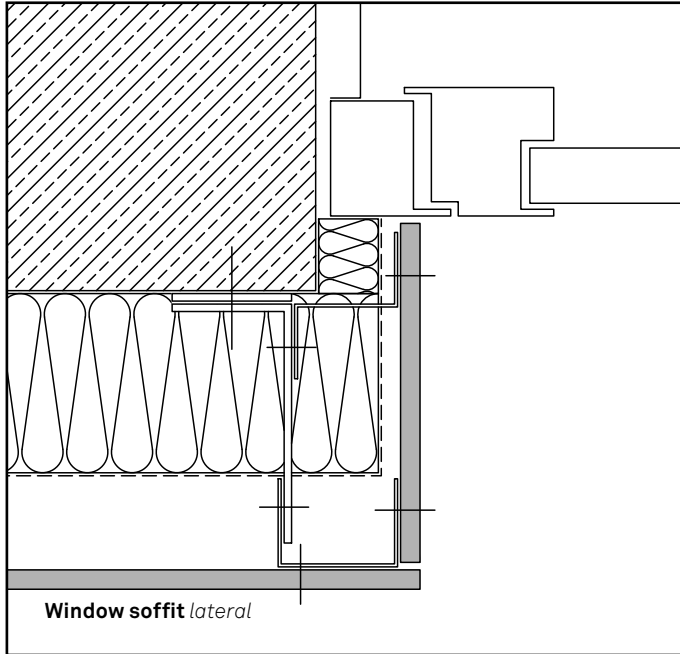

Window soffit *lateral*

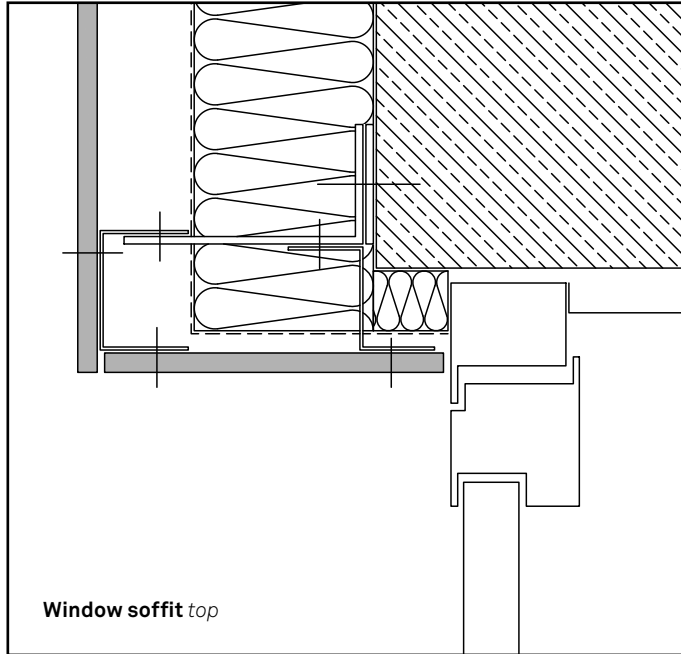

Window soffit *top*

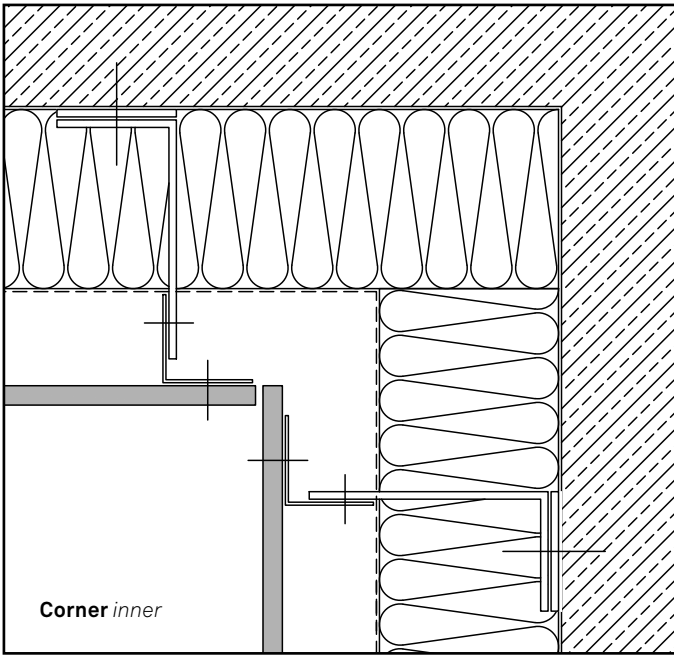

Corner *inner*

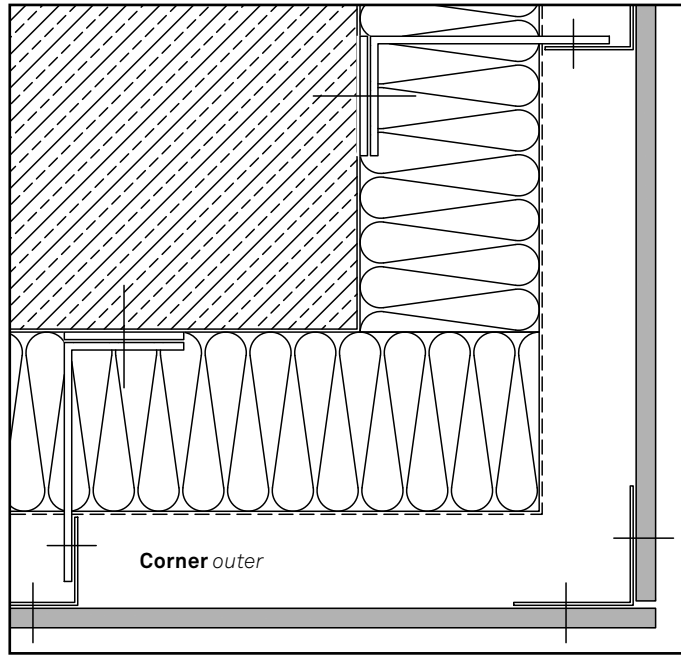

Corner *outer*

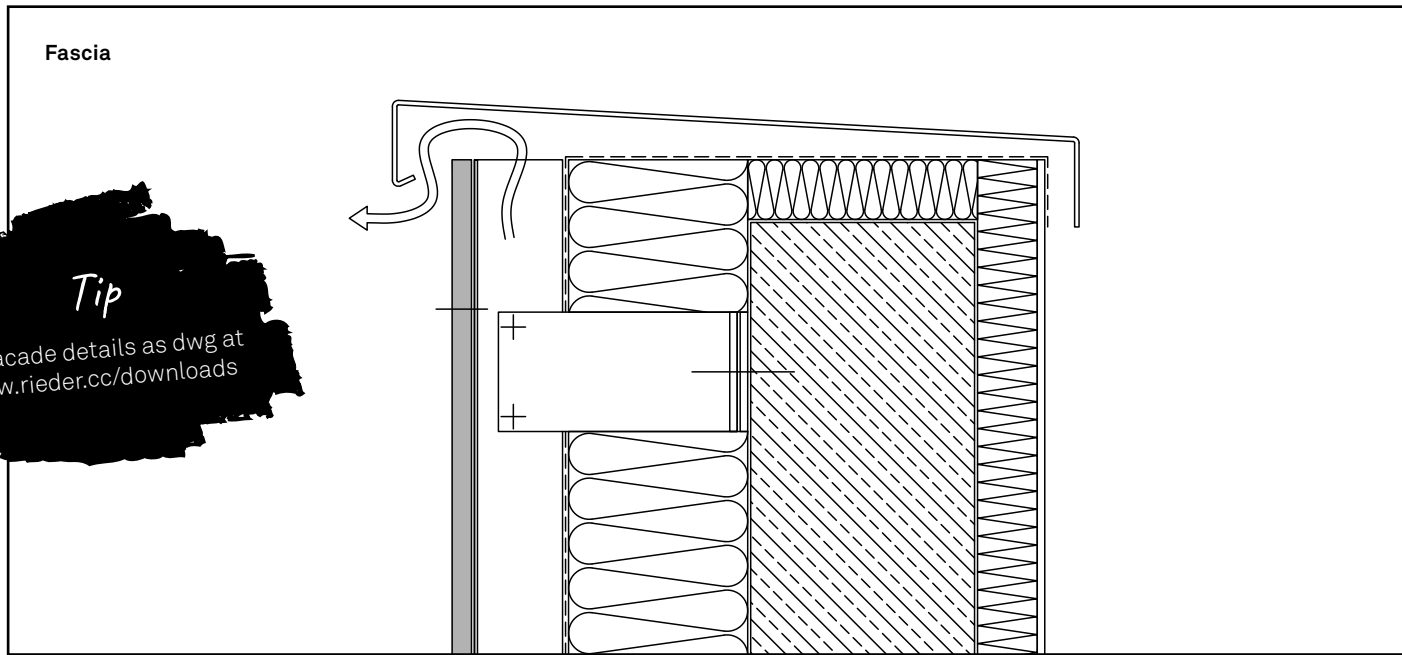

Fascia

Tip
All facade details as dwg at www.rieder.cc/downloads

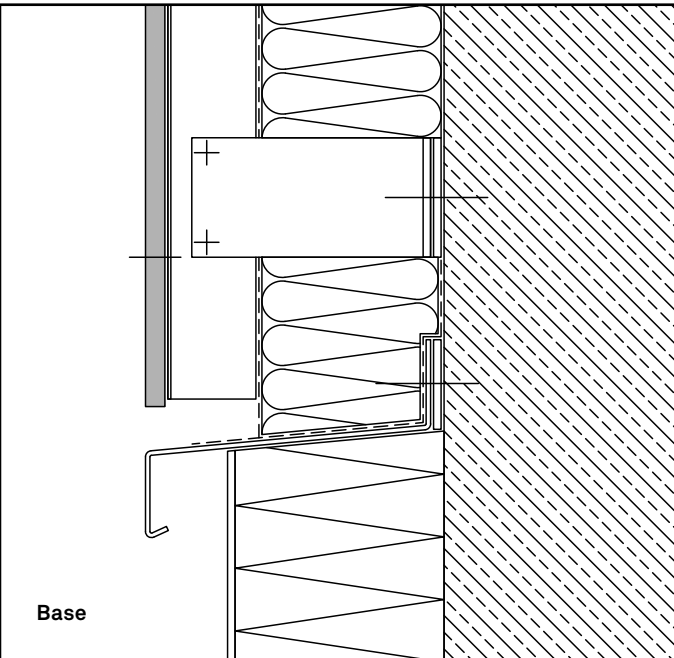

Base

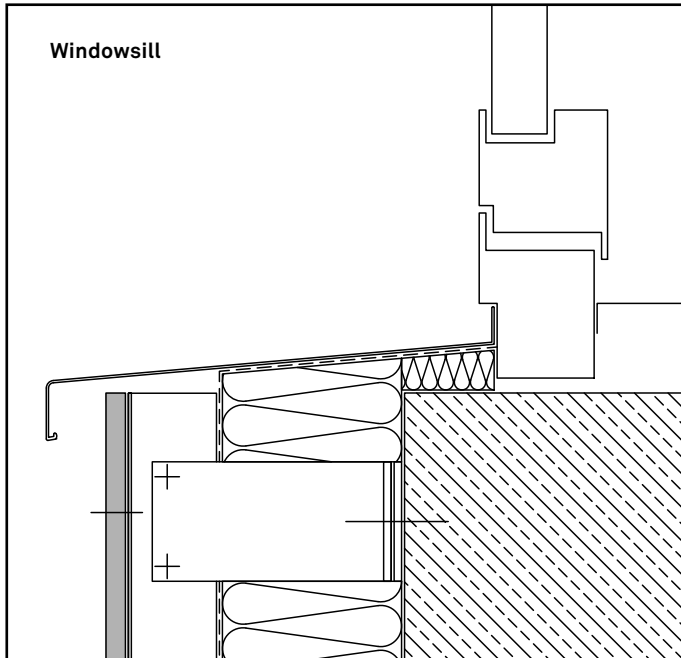

Windowsill

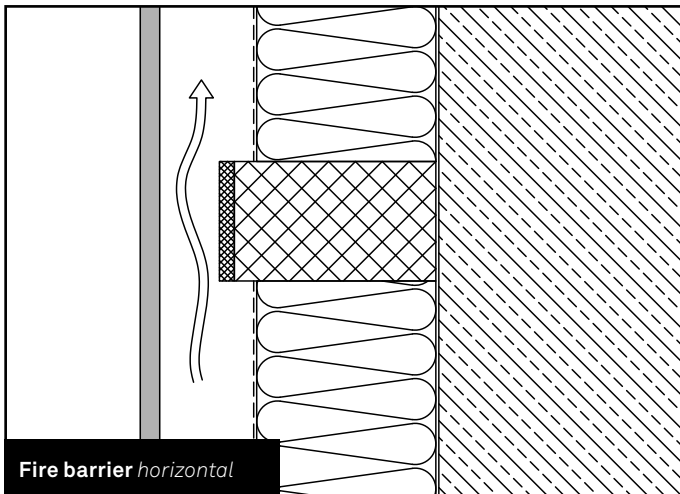

Fire barrier *horizontal*

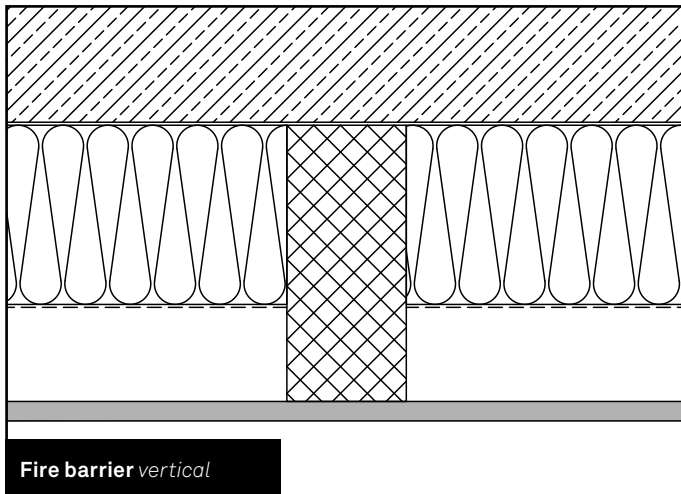

Fire barrier *vertical*

Processing details

Equipment

- > Special undercut anchor drilling machine for re-drilling on the construction site
- > Fastener recommended in the approval ETA-06/0220: Keil anchor type KH AA or KH BH (www.keil.eu) with the setting depth of $h_s = 8.5$ mm and measuring gauge to check the bore
- > Compressor or vacuum cleaner
- > Torque wrench and Allen key (for threaded screws)
- > All mounting components and system-relevant tools must be from the same system and must be coordinated with each other (Keil company, www.keil.eu).
- > The manufacturer's handling guidelines must be observed.

Holes for undercut anchors

- > It is recommended to have holes drilled at the factory. In case of re-drilling at the construction site: according to approval with system components and devices from Keil
- > Undercut anchor setting depth $h_s = 8.5$ mm
- > Implementation by the Keil company is recommended. The manufacturer's drilling guidelines must be observed.
- > The drill hole must be cleansed of drilling dust before the anchor is inserted.
- > Edge distances according to the approval ETA-06/0220 60 mm from the edge or 60 x 60 mm from the panel corner.
- > Rieder recommends that a soft and easy-to-clean intermediate layer such as carpet, hard foam insulation board or similar is placed between the panel and the worktable as protection.

Substructure

- > Exclusively metal substructure

Mounting

- > The panels can be mounted vertically or horizontally on the facade.
- > The panels are connected by means of undercut anchors with single or double clamps and then hooked onto the substructure. Rieder recommends lubricating the thread with a suitable lubricant to allow the thread to be loosened again and to avoid rubbing the thread. Caution: screws or bolts that are too long can break through or damage the drill hole through to the front of the panel.
- > The substructure or agraffes are suspended at the construction site in horizontal or vertical aluminium support profiles or equivalent substructures.
- > Each facade panel is to be fixed technically without constraint with at least four anchors in a rectangular arrangement using single or double agraffes.

- > The top row of agraffes is used to transfer the dead load of the panels. Two of the upper, external agraffes are vertically adjustable for easy height adjustment of the panels. One of these two agraffes is designed as a fixed point to prevent the panel from slipping. All other agraffes must be checked visually for correct fit - hooked in far enough but sliding vertically and horizontally. An equivalent procedure must also be used for alternative project-specific substructures.
- > The undercut anchor must be tightened with a torque of 2.50 - 4.00 Nm.
- > Suitable screws with ratchet teeth (KH AA) or bolts with nuts with ratchet teeth (KH BH) are available in various lengths to match the substructure used.
- > Attention must be paid to the fact that the agraffes and the agraffe-supporting profile belong to one system and are coordinated with each other and that the screws or bolts with the correct clamping thickness are used.
- > Some system manufacturers of substructures recommend a thin EPDM insert between the agraffe and the panel to ensure a softer/more flexible support - observe the maximum values determined by the system. This recommendation must be followed and taken into account in the approval.
- > With other substructures, care must be taken to ensure that these are connected to the panel without constraint, so that the substructure can slide relative to the panels, under thermal or other physical influences.

Jointing

Rieder recommends a joint width of at least 8 mm. The maximum joint width depends on the respective applicable national regulation.

Optional services

In the Rieder factory the panels are cut to the shapes and sizes provided and the special undercut holes for the undercut anchors are prepared on request. Although Rieder ensures that drill holes are dust-free, they must be checked again by the installer before fixing. Undercut anchors including the corresponding screws or bolts and nuts can be obtained from Rieder. Agraffes provided can be screwed on by Rieder as a service.

Characteristic values and statics according to ETA-06/0220

Panel parameters fibreC	
Panel thickness	13 mm ± 10 %
Reaction to fire	A1 - non-combustible A2-s1,d0 - non-combustible
Characteristic flexural stress	$\sigma_{Rk} = 16.2$ N/mm ²
Partial safety coefficient ¹	$\gamma_M = 2.0$
Young's modulus ²	$E = 20,000$ (10,000) N/mm ²
Poisson's ratio	$\nu = 0.2$
Coefficient of thermal expansion	$\alpha_T = 10 \times 10^{-6}$ 1/K
Dead load	$g = 0.27$ N/mm ² (panel thickness $d = 13$ mm)

Anchor parameters	
Reaction to fire	A1
Type of mounting	flush mounting or distance mounting - see ETA-06/0220
Type of anchor	KH AA 8.5 with M6 hexagonal locking screw, KH PH 8.5 with M6 threaded bolt and M6 hexagon locking nut, KH BH with stepped M6/M8 threaded bolts and M8 hexagon locking nut
Screw length	$h_s = 11.5$ mm + d_{fix} (thickness of the substructure to be fixed)
Bolt length	$h_s = 11.5$ mm + d_{fix} + d_{nut} + 1.5 mm
Tightening torque screw/nut	2.5 to 4.0 Nm
Characteristic load capacity for centric tension ³	$N_{Rk} = 1.2$ kN
Characteristic load capacity for transverse tension ³	$V_{Rk} = 3.2$ kN
Partial safety coefficient ¹	$\gamma_M = 2.0$
Setting depth	$h_s \geq 8.5$ mm
Distance from edge	a_x or $a_y \geq 60$ mm or $0.1 \times a$
Centre distance	$a \leq 800$ mm; Rieder recommends a distance of max. 600 mm.
Max. permissible angular deviation ⁴	2° between panel and agraffe

1) In the absence of other national regulations

2) Verification of serviceability with $E = 10,000$ N/mm²

3) If the anchor is simultaneously stressed by centric tension and transverse tension, the following interaction equation must be observed: $\frac{N_{Sd}}{N_{Rd}} + \frac{V_{Sd}}{V_{Rd}} \leq 1,1$

4) In the case of spaced installation, it must be demonstrated when using horizontal support profiles that:

> the agraffes do not rest on the facade panel due to torsion of the horizontal profile and twisting of the facade panel

> the sum of the angle α from the torsion of the horizontal profile and the rotation of the facade panel at the anchor point does not exceed the value $\alpha = 2^\circ$.

According to the certification, the panels may be used up to a construction height of 100 m. Other heights must be checked by the installer with a separate approval. Panels which are used in overhead areas must be secured with a suitable substructure system. Rieder recommends securing these panels additionally with a short rope loop. Combinations of attachment options are not foreseen and must be tested as needed from design technology, structural and construction physics aspects. Assembly must be tension-free regardless of the attachment system that is used.

Drill and drill hole values	
Type of drill	special drill HM 12/0.8
Quality control drilling	regularly using Keil measuring gauge according to manufacturer's specifications. If the HSA drillings are made by Rieder, the quality control is done by Rieder and the drillings do not have to be checked by the installer.
Hole diameter	$D_0 = 7 \text{ mm}$
Undercut diameter	$D_1 = 9 \text{ mm}$
Height of hexagon anchor sleeves	3 mm
Spanner gap hexagon anchor sleeve	SW = 9 mm
Drill hole depth/setting depth	$h_s = 8.5 \text{ mm}$ (with 13 mm panel thickness)

Requirements for the aluminium substructure panel	
Area of application	ventilated curtain wall facade
System	double layer system
Alignment of support profiles	horizontal
Alloy	EN AW 6060 or EN WA 6063 according to DIN EN 755-2
Tensile strength	$R_m = 215 \text{ N/mm}^2$
Yield point	$R_{p0.2} = 160 \text{ N/mm}^2$
Max. deflection of substructure	1/300
Max. panel deflection	1/100
Profile butt joints	no requirements

Undercut anchor holes formparts.mono

When planning formparts.mono, the dimensions indicated must be observed. These represent the accessible areas for the respective undercut drilling machines. The exclusion zone is included in the data. If drilling is carried out at the Rieder factory, a special drilling machine makes it possible to reduce the edge distance to 35 mm.

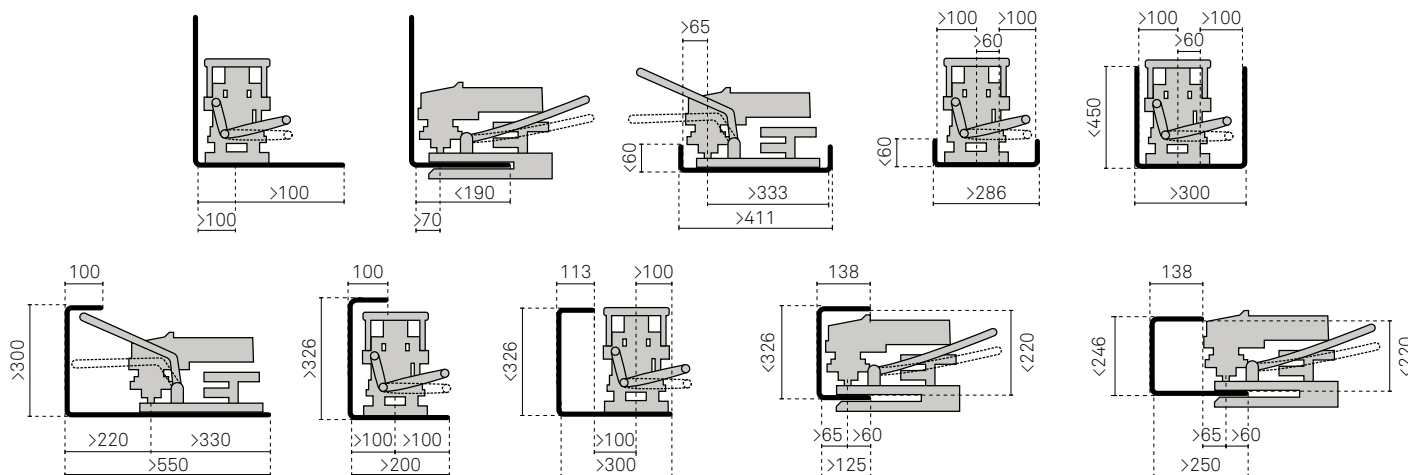

Permissible characteristic wind load (kN/m²)

Calculation of the permissible wind loads on the facade panels for the following fixing grids:

Mounting distances

Horizontal x Vertical Horizontal = 200, 400, 600 mm
Vertical = 300, 400, 500, 600 mm

Edge distances

60 mm < a < 100 mm

Horizontal mounting distance of 200 mm				
System	Vertical mounting distance			
	300 mm	400 mm	500 mm	600 mm
2 x 2	8.00 kN/m ²	5.82 kN/m ²	3.73 kN/m ²	2.59 kN/m ²
2 x 3	5.33 kN/m ²	4.00 kN/m ²	3.20 kN/m ²	2.59 kN/m ²
2 x n	6.06 kN/m ²	4.55 kN/m ²	3.64 kN/m ²	3.03 kN/m ²
3 x 3	4.27 kN/m ²	3.20 kN/m ²	2.56 kN/m ²	2.13 kN/m ²
3 x n	4.85 kN/m ²	3.64 kN/m ²	2.91 kN/m ²	2.42 kN/m ²

Horizontal mounting distance of 400 mm				
System	Vertical mounting distance			
	300 mm	400 mm	500 mm	600 mm
2 x 2	5.33 kN/m ²	4.44 kN/m ²	3.73 kN/m ²	2.59 kN/m ²
2 x 3	3.56 kN/m ²	2.67 kN/m ²	2.13 kN/m ²	1.78 kN/m ²
2 x n	4.04 kN/m ²	3.03 kN/m ²	2.42 kN/m ²	2.02 kN/m ²
3 x 3	2.13 kN/m ²	1.60 kN/m ²	1.28 kN/m ²	1.07 kN/m ²
3 x n	2.42 kN/m ²	1.82 kN/m ²	1.45 kN/m ²	1.21 kN/m ²

Horizontal mounting distance of 600 mm				
System	Vertical mounting distance			
	300 mm	400 mm	500 mm	600 mm
2 x 2	2.59 kN/m ²	2.59 kN/m ²	2.59 kN/m ²	2.50 kN/m ²
2 x 3	2.59 kN/m ²	2.00 kN/m ²	1.60 kN/m ²	1.33 kN/m ²
2 x n	3.03 kN/m ²	2.27 kN/m ²	1.82 kN/m ²	1.52 kN/m ²
3 x 3	1.42 kN/m ²	1.07 kN/m ²	0.85 kN/m ²	0.71 kN/m ²
3 x n	1.62 kN/m ²	1.21 kN/m ²	0.97 kN/m ²	0.81 kN/m ²

Processing details

Equipment

- > Drill
- > Drill with depth stop
- > Gesipa PowerBird®, Gesipa PowerBird Pro® or equivalent riveting machine
- > Measuring gauge to check the bore
- > Compressor or vacuum cleaner for cleaning the drill hole
- > All mounting components and system-relevant tools must be from the same system and must be coordinated with each other (SFS Group, www.sfsintec.biz).
- > The manufacturer's mounting guidelines must be observed.
- > Depending on the system, the material thickness of the agraffe or substructure to be riveted must be 3 mm.

Rieder Power Anchor (RPA)

- > The RPA consists of an outer sleeve with a hexagonal head and a sleeve with a thread at the end.
- > The material used is A4 stainless steel.
- > There are tensioning pins with a diameter $D = 3.3$ mm made of galvanized carbon steel for the riveting process.
- > A 1 mm thick rubber disc made of EPDM is available for flexible mounting of the RPA on the substructure or agraffe.
- > With a Gesipa PowerBird riveting machine the mandrel is pulled through the sleeve. Through this process, the sleeve with the thread expands in the panel and the agraffe or substructure is positively fastened. During this process, the expansion of the material can lead to slight stress lines, which are caused by the system and do not represent any relevant damage to the panel.

Drilling for Rieder Power Anchor

- > Ensure that the drilling is carried out at 90° to the panel.
- > The drill hole must be cleansed of drilling dust before the anchor is inserted.
- > During the riveting process, care must be taken to ensure that it is carried out without additional pressure on the riveting machine, as otherwise there may be conchoidal damage on the visible side.
- > The RPA hole is always drilled from the back of the panel.
- > Rieder recommends that a soft and easy-to-clean intermediate layer such as carpet, hard foam insulation board or similar is placed between the panel and the worktable as protection.

Substructure

- > Aluminium or steel substructure only

Mounting

- > The panels can be mounted vertically or horizontally on the facade.
- > The drill hole must be cleaned and freed from drilling dust before the riveting process is started.
- > The RPA is connected to the 3 mm thick substructure, a single or double agraffe, using a suitable tool similar to that used for a riveting process. During the riveting process, care must be taken to ensure that it is carried out without additional pressure on the riveting machine, as otherwise there may be conchoidal damage on the visible side.
- > The substructure or agraffes are suspended at the construction site in horizontal or vertical aluminium support profiles or equivalent substructures.
- > Each facade panel is to be fixed technically without constraint with at least four anchors in a rectangular arrangement using single or double agraffes.
- > The top row of agraffes is used to transfer the dead load of the panels. Two of the upper, external agraffes are vertically adjustable for easy height adjustment of the panels - comply with system-related maximum values. One of these two agraffes is designed as a fixed point to prevent the panel from slipping.
- > All agraffes must be checked visually for correct fit. Hooked in far enough, sliding vertically and horizontally.
- > An equivalent procedure must also be used for alternative substructures.
- > With other substructures, care must be taken to ensure that these are connected to the Rieder panel without constraint, so that the substructure can slide relative to the panels, under thermal or other physical influences.
- > Some system manufacturers of substructures recommend a thin EPDM insert between the agraffe and the panel to ensure a softer/more flexible support. This recommendation must be followed and taken into account in the approval.

Jointing

Rieder recommends a joint width of at least 8 mm. The maximum joint width depends on the respective applicable national regulation.

Optional services

At the Rieder factory, the panels can be cut to size on request and the blind holes for RPA mounting can be provided on the basis of the installer's specifications. Although Rieder ensures that drill holes are dust-free, they must be checked again by the installer before completing the riveting process.

Characteristic values and statics according to Z-31.4-166

Panel parameters fibreC	White cement recipes	Grey cement recipes
Panel thickness	13 mm ± 10 %	13 mm ± 10 %
Reaction to fire	A1 - non-combustible A2-s1,d0 - non-combustible	A1 - non-combustible A2-s1,d0 - non-combustible
Design value of the bearing resistance for bending $R_{Bz,d}$	6.2 N/mm ²	7.4 N/mm ²
Young's-modulus for deformation calculation	10,000 N/mm ²	10,000 N/mm ²
Young's-modulus for constraint calculation	30,000 N/mm ²	30,000 N/mm ²
Coefficient of thermal expansion	$\alpha_T = 10 \times 10^{-6} 1/K$	$\alpha_T = 10 \times 10^{-6} 1/K$
Dead load	$g = 0.29$ N/mm ² (panel thickness $d = 13$ mm)	$g = 0.29$ N/mm ² (panel thickness $d = 13$ mm)

Anchor data	
Type of mounting	flush mounting
Type of anchor	RPA or TUC-S (designation for SFS Intec)
Relevant approval	Z-31.4-166
Anchor parts and materials	sleeve: A4 stainless steel, material number 1.4401, AISI 316 tensioning pin: galvanized carbon steel rubber disc: EPDM, 1 mm
Anchor length	$L_A = 14$ to 15 mm
Anchor diameter	$D_A = 6$ mm
Width across flat anchor head	SW = 8 mm
Clamping thickness	$t_{\text{substructure}} = 3.0$ mm

Rated values	White cement recipes		Grey cement recipes	
	$a = 200 \leq a \leq 800$ mm	$a = 800 \leq a \leq 1125$ mm	$a = 200 \leq a \leq 800$ mm	$a = 800 \leq a \leq 1125$ mm
Centre distance ¹				
Anchoring depth	$h_v = 10$ mm	$h_v = 10$ mm	$h_v = 10$ mm	$h_v = 10$ mm
Drill hole distance to edge	$a \geq 100$ mm	$a \geq 100$ mm	$a \geq 100$ mm	$a \geq 100$ mm
Centric tension N_{Rd}^2	0.51 kN	0.37 kN	0.51 kN	0.37 kN
Transverse tension V_{Rd}^2	1.56 kN	1.56 kN	1.77 kN	1.77 kN
Drill hole distance to edge	$a_{rx} \geq 100$ mm $a_{ry} \geq 30$ mm	$a_{rx} \geq 100$ mm $a_{ry} \geq 30$ mm	$a_{rx} \geq 100$ mm $a_{ry} \geq 30$ mm	$a_{rx} \geq 100$ mm $a_{ry} \geq 30$ mm
Centric tension N_{Rd}^2	0.34 kN	0.26 kN	0.29 kN	0.26 kN
Transverse tension V_{Rd}^2	1.15 kN	1.15 kN	1.14 kN	1.14 kN

1) Rieder recommends a spacing of max. 600 mm.

2) In case of simultaneous stressing of the anchor by centric tension and transverse tension, the following interaction equation must be observed as V_{Ed} the dead load of the panel on the anchor must be used as acting transverse load: $\left(\frac{N_{Ed}}{N_{Rd}}\right) + \left(\frac{V_{Ed}}{V_{Rd}}\right) \leq 1$

Combinations of attachment options are not foreseen and must be tested as needed from design technology, structural and construction physics aspects. Assembly must be tension-free regardless of the attachment system that is used.

RPA drilling and anchor values	
Type of drill	depth stop (item 1478567) with VHM drill 6.0 x 45 (item no. 1479984)
Quality control drilling	1 % of the drill holes must be checked for geometry. Nominal size: Ø 5.9 – 6 mm; further information - see approval or manufacturer's information
Drill hole diameter	$D_L = 6.0 \text{ mm } (-0.0 \text{ mm}/+0.1 \text{ mm})$
Drill hole depth	$h_v = 10 \text{ mm } (-0.1 \text{ mm}/+1.0 \text{ mm})$
Recommended assembly tool	Gesipa PowerBird®, Gesipa PowerBird Pro® or equivalent

Requirements for the aluminium substructure panel	
Area of application	ventilated curtain wall facade
System	double layer system
Alignment of support profiles	horizontal
Alloy	EN AW 6060 or EN WA 6063 according to DIN EN 755-2
Tensile strength	$R_m = 215 \text{ N/mm}^2$
Yield point	$R_{p0.2} = 160 \text{ N/mm}^2$
Max. deflection of substructure	1/300
Max. panel deflection	1/100
Profile butt joints	no requirements

Permissible characteristic wind load (kN/m²)

Calculation of the permissible wind loads on the facade panels for the following fixing grids:

Mounting distances

Horizontal x Vertical Horizontal = 200, 400, 600 mm
Vertical = 300, 400, 500, 600 mm

Edge distances

60 mm < a < 100 mm

Horizontal mounting distance of 200 mm				
System	Vertical mounting distance			
	300 mm	400 mm	500 mm	600 mm
2 x 2	6.71 kN/m ²	5.58 kN/m ²	3.73 kN/m ²	2.59 kN/m ²
2 x 3	4.47 kN/m ²	3.34 kN/m ²	2.67 kN/m ²	2.21 kN/m ²
2 x n	5.08 kN/m ²	3.80 kN/m ²	3.02 kN/m ²	2.51 kN/m ²
3 x 3	3.58 kN/m ²	2.67 kN/m ²	2.13 kN/m ²	1.77 kN/m ²
3 x n	4.05 kN/m ²	3.02 kN/m ²	2.40 kN/m ²	1.99 kN/m ²

Horizontal mounting distance of 400 mm				
System	Vertical mounting distance			
	300 mm	400 mm	500 mm	600 mm
2 x 2	4.45 kN/m ²	3.69 kN/m ²	3.15 kN/m ²	2.59 kN/m ²
2 x 3	2.96 kN/m ²	2.21 kN/m ²	1.76 kN/m ²	1.46 kN/m ²
2 x n	3.36 kN/m ²	2.51 kN/m ²	1.99 kN/m ²	1.65 kN/m ²
3 x 3	1.77 kN/m ²	1.32 kN/m ²	1.05 kN/m ²	0.87 kN/m ²
3 x n	2.01 kN/m ²	1.50 kN/m ²	1.19 kN/m ²	0.99 kN/m ²

Horizontal mounting distance of 600 mm				
System	Vertical mounting distance			
	300 mm	400 mm	500 mm	600 mm
2 x 2	2.59 kN/m ²	2.59 kN/m ²	2.34 kN/m ²	2.04 kN/m ²
2 x 3	2.21 kN/m ²	1.64 kN/m ²	1.31 kN/m ²	1.08 kN/m ²
2 x n	2.50 kN/m ²	1.86 kN/m ²	1.48 kN/m ²	1.22 kN/m ²
3 x 3	1.17 kN/m ²	0.87 kN/m ²	0.69 kN/m ²	0.57 kN/m ²
3 x n	1.33 kN/m ²	0.99 kN/m ²	0.78 kN/m ²	0.65 kN/m ²

Processing details

Equipment

- > Bonding system: "Sika Tack-Panel" (no restrictions) or "Innotec Project System" (for selected colours)
- > Adhesive, cleaner and primer
- > Glazing tape
- > Abrasive fleece
- > Primer pad
- > Cleaning cloths
- > Spacer set
- > Spacer for joints

Substructure

- > Aluminium substructure only

Mounting

- > The panels can be mounted vertically or horizontally on the facade.
- > The system "Sika Tack-Panel" with approval Z-10.8-408 (no restrictions) or "Innotec Project System" with approval Z-10.8-483 (for selected colours) is to be used as adhesive bonding.
- > Weather conditions must be strictly observed: application temperature system-dependent 5 °C - 35 °C, air humidity maximum 75 %, temperature of the substructure min. 3 °C higher than dew point temperature.
- > Generally, manufacturer's application guidelines must be observed.
- > All those involved in the project must be familiar with the regulations, guidelines, rules, restrictions and the like, as stated in the approval of the respective products.
- > Only companies certified to use the "Sika Tack-Panel" system are allowed to carry out bonding work.

Preparation of the substructure

- > The aluminium substructure is to be sanded and cleaned over the entire bonding area using abrasive fleece.
- > Then an adhesive primer is to be applied evenly to the entire adhesive surface using a primer pad.
- > After a defined flash-off time, the double-sided adhesive backing tape is stuck on, whereby the adhesive surface aligned with the panel still remains protected.

Preparation of the fibreC products

- > Depending on the system, the products are also sanded, cleaned and pre-treated with primer.
- > After the primer has flashed off, the panel can be adhered to the facade.

Adhering to the facade

- > The adhesive must be applied to the prepared substructure in a geometrically defined triangular shape.
- > The protective tape of the double-sided adhesive presentation tape is pulled off.
- > The facade panel is brought into position using spacers and then pressed evenly onto the substructure and thus bonded.
- > The different regulations of the respective manufacturer or the respective certification must be observed without fail.
- > During processing, the surroundings must be dust-free and protected from moisture.
- > The min. and max. temperatures must not be exceeded or undercut during processing and during a specified curing period.
- > The processing steps are to be recorded and archived according to specifications.

Jointing

Rieder recommends a joint width of at least 8 mm. The maximum joint width depends on the respective applicable national regulation.

Optional services

On request, the panels are cut to the provided shapes and formats in the Rieder factory.

Characteristic values and statics according to Z-10.8-408 and Z-10.8-483

Panel parameters fibreC	Z-10.8-408 (White cement recipes)	Z-10.8-408, Z-10.8-483 (Grey cement recipes)
Panel thickness	13 mm ± 10 %	13 mm ± 10 %
Reaction to fire	A1 - non-combustible A2-s1,d0 - non-combustible	A1 - non-combustible A2-s1,d0 - non-combustible
Design value of the bearing resistance for bending $R_{BZ,d}$	6.2 N/mm ²	7.4 N/mm ²
Young's-modulus for deformation calculation	10,000 N/mm ²	10,000 N/mm ²
Young's-modulus for constraint calculation	30,000 N/mm ²	30,000 N/mm ²
Coefficient of thermal expansion	$\alpha_T = 10 \times 10^{-6} 1/K$	$\alpha_T = 10 \times 10^{-6} 1/K$
Dead load	$g = 0.29 \text{ N/mm}^2$ (panel thickness $d = 13 \text{ mm}$)	$g = 0.29 \text{ N/mm}^2$ (panel thickness $d = 13 \text{ mm}$)

Adhesive parameters	"Sika Tack-Panel"	"Innotec Project System"
Relevant approval	Z-10.8-408	Z-10.8-483
fibreC colours	all colours	selected colours
Fire safety	flame resistant	flame resistant
Type of fastening	force fit	force fit
Additional mechanical fastening	not necessary	not necessary
Bonding direction	vertical	vertical
Design value of the bearing resistance for tensile load	0.3 N/mm ²	0.3 N/mm ²
Design value of the bearing resistance for shear load	0.2 N/mm ²	0.2 N/mm ²
Joint width to be used	12 mm	12 mm
Minimum requirement	1 adhesive strip and 1 mounting tape	1 adhesive strip and 1 mounting tape
Max. permissible shear deformation	1 mm	1 mm
Building height restriction	according to proof of stability & fire protection regulations	according to proof of stability & fire protection regulations
Storage	according to manufacturer's information	according to manufacturer's information
Adhesive best before date	printed on packaging	printed on packaging

Requirements of the aluminium substructure	“Sika Tack-Panel“	“Innotec Project System“
Area of application	ventilated curtain wall facade	ventilated curtain wall facade
System	single layer system	single layer system
Profile direction	vertical	vertical
Alloy	EN AW 6060 o. EN WA 6063 according to DIN EN 755-2	EN AW 6060 o. EN WA 6063 according to DIN EN 755-2
Tensile strength	$R_m = 215 \text{ N/mm}^2$	$R_m = 215 \text{ N/mm}^2$
Yield point	$R_{p02} = 160 \text{ N/mm}^2$	$R_{p02} = 160 \text{ N/mm}^2$
Width/thickness substructure field centre/end field	40 mm/1.5 mm	40 mm/1.5 mm
Width/thickness substructure jointing	90 mm/1.5 mm	90 mm/1.5 mm
Max. deflection of substructure	1/300	1/300
Max. panel deflection	1/100	1/100
Profile butt joints	not in panel area	not in panel area

Circumstances	“Sika Tack-Panel“	“Innotec Project System“
Implementation conditions on the construction site	weather and dust protection	weather and dust protection
Application temperature	5 °C to 35 °C	5 °C to 40 °C
Temperature during the adhesive curing	0 to 5 hrs not below 5 °C & 24 to 48 hrs not above 40 °C	0 to 5 hrs not below 5 °C & 24 to 48 hrs not above 40 °C
Humidity	maximal 75 %	maximal 75 %
Application temperature above dew point	at least 3 °C above	at least 3 °C above

Preparation & processing substructure	“Sika Tack-Panel“	“Innotec Project System“
Surface properties	clean, dry and free of grease	clean, dry and free of grease
Rub down the substructure with	e.g. sialvlies speed very fine or similar	e.g. Scotch Brite or similar
Cleaning of the rubbed down adhesion area	Paper fleece with “Sika Aktivator-205” or “Sika Cleaning Agent 5”	“Innotec Multi Wipe” with “Innotec Multisol Projekt”
Rubbing dry	not necessary	with “Innotec Multi Wipe”
Flash off time	at least 10 min	at least 10 min
Applying the primer	“Sika Tack-Panel Primer“	no primer
Flash off time of primer	at least 30 min maximum 8 hrs	no flash off time
Applying the mounting strip	“Sika Tack-Panel Mounting Strip“	“Fixation Tape 2100“
Spraying the adhesive	“Sika Tack-Panel“	“Innotec Adheseal Project“
Adhesive geometry	triangular shape $w = 8 \text{ mm}$, $h = 10 \text{ mm}$	triangular shape $w = 8 \text{ mm}$, $h = 10 \text{ mm}$
Distance to mounting strip	at least 5 mm	at least 6 mm
Open processing time from application	max. 10 min	max. 10 min
Adhesive curing time	72 hrs	72 hrs

Preparation & processing panel	“Sika Tack-Panel“	“Innotec Project System“
fibreC colours	all colours	selected colours
Surface properties	clean, dry and free of grease	clean, dry and free of grease
Sanding the panel	with abrasive fleece grit 60 - 80	with abrasive fleece grit 120
Cleaning of the sanded adhesion area	dust removal	“Multi Wipe” soaked with “Multisol”
Rubbing dry	not necessary	with “Innotec Multi Wipe”
Applying the primer	“Sika Tack-Panel Primer“	“Imprasol“
Flash off time for primer	at least 30 min maximum 8 hrs	at least 10 min
Max. panel dimensions	3600 mm x 1250 mm x 13 mm	3600 mm x 1250 mm x 13 mm

Quality control	“Sika Tack-Panel“	“Innotec Project System“
Protocolling the processing	yes, according to manufacturer’s protocol	yes, according to manufacturer’s protocol
Tensile tests during processing	per production batch min. 5 tensile tests each at 20 °C according to approval	2 per production week at 20 °C according to approval

Permissible characteristic wind load (kN/m²)

Mounting and edge distances

x = centre distance substructure

B = panel width maximum 1,250 mm

L = panel length maximum 3,600 mm

Single span panel

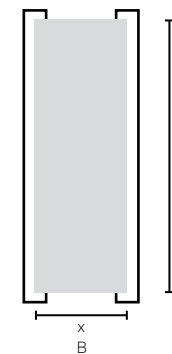

Double span panel

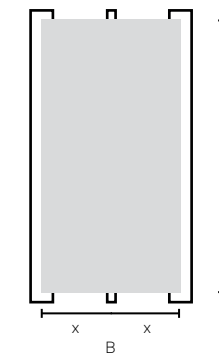

Multi span panel

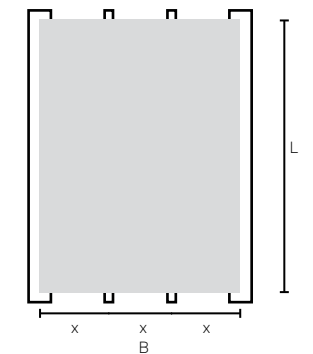

Raster direction x (mm)	400	500	600
1 span	5,76 kN/m ²	3,69 kN/m ²	2,15 kN/m ²
2 span	3,59 kN/m ²	2,81 kN/m ²	2,28 kN/m ²
3 span	3,59 kN/m ²	2,81 kN/m ²	2,28 kN/m ²

Processing details

Equipment

- > Facade rivets Alu/Niro with head coating; dimensions $\varnothing 5 \times 23$ mm; head diameter 14 mm
- > Fixed point sleeve $D_A = 7.7 \times D_I = 5.1 \times L = 12$ mm
- > If necessary, sliding point sleeve clamping range 14 - 17.5 mm
- > Pop riveter or riveting machine with rivet setting gauge matched to the rivet
- > Special drills with drilling jig
- > Spacers for joints
- > Vacuum cleaner or compressor
- > The guidelines of the respective manufacturers or the corresponding approval are to be observed.

- > When setting the rivets, it is recommended to use a rivet setting gauge matching to the rivets to prevent damage to the rivet head. The rivet setting gauge has a load-distributing effect and creates a small clearance between the rivet head and the facade panel, so that movements in the facade panel can be absorbed.
- > All other holes are sliding points so that the panel can move relative to the substructure without constraint.
- > Recommended rivets with colours specially matched to fibreC surfaces are available from various fastener manufacturers. By specifying the fibreC standard colour used, the manufacturer will give you a suitable recommendation for the colour of the rivets. Rivets in matching colours can also be obtained from Rieder.

Drill hole for rivets

- > On the construction site, the holes in the substructure must be drilled using a drilling jig to ensure that the drill hole, and thus the rivet, is centred. Substructure drill hole $\varnothing 5.1$ mm
- > Usually the through holes of the panel are drilled with a diameter of $\varnothing 8$ mm.
- > The drilling dust must be removed from the drilled hole.
- > For panels longer than 3.6 m, the rivet with a head diameter of $\varnothing 16$ mm and a sliding point bore of $\varnothing 10$ mm must be selected to avoid thermal stress. The fixed-point drill hole must be $\varnothing 8$ mm because of the fixed-point sleeve.

Jointing

Rieder recommends a joint width of at least 8 mm. The maximum joint width depends on the respective applicable national regulation.

Optional services

At the Rieder factory, the panels are cut on request to the shapes and sizes provided and the through holes for rivet mounting are prepared on the basis of the information provided by the installer.

Substructure

- > Exclusively metal substructure
- > The substructure must be adjustable in order to be able to compensate for construction tolerances and allow for a constraint-free installation.

Mounting

- > The panels can be mounted on the facade vertically or horizontally by means of rivets on vertical aluminium support profiles.
- > Separable spacers (wedges) prevent the joints from bursting out.
- > Each panel must be fixed to the substructure with at least four matching fasteners.
- > Each facade panel requires a fixed point, which is produced using fixed point sleeves. By default, this fixed point is located in one of the upper corners of the panels and it should be set in the same corner for each panel.
- > Rieder also recommends the use of a sliding point sleeve at the opposite corner to ensure that the panel is supported without constraint.

Characteristic values and statics according to Z-31.4-166

Panel parameters fibreC	White cement recipes	Grey cement recipes
Panel thickness	13 mm \pm 10 %	13 mm \pm 10 %
Reaction to fire	A1 - non-combustible A2-s1,d0 - non-combustible	A1 - non-combustible A2-s1,d0 - non-combustible
Design value of the bearing resistance for bending $R_{Bz,d}$	6.2 N/mm ²	7.4 N/mm ²
Young's-modulus for deformation calculation	10,000 N/mm ²	10,000 N/mm ²
Young's-modulus for constraint calculation	30,000 N/mm ²	30,000 N/mm ²
Coefficient of thermal expansion	$\alpha_T = 10 \times 10^{-6} 1/K$	$\alpha_T = 10 \times 10^{-6} 1/K$
Dead load	$g = 0.29$ N/mm ² (panel thickness $d = 13$ mm)	$g = 0.29$ N/mm ² (panel thickness $d = 13$ mm)

Rivet data	
Description	aluminium head and sleeve in stainless steel rivet mandrel with painted or powder-coated rivet head
Relevant approval	Z-31.4-166
Rivet mandrel and materials	sleeve: Al Mg5 material no. EN AW-5119 according to DIN EN 573-3 rivet mandrel: stainless steel, material no. 1.4541
Rivet dimensions	$D_S = 5$ mm $L_S = 23$ mm
Head diameter	$D_K = 14$ mm $D_K = 16$ mm
Clamping area	13.5 to 17.5 mm
Drill hole in the panel	$D_{P-K14} = 8$ mm $D_{P-K16} = 10$ mm
Drill hole in the substructure	$D_{substructure} = 5.1$ mm
Drilling the hole in the substructure	with drilling jig
Fixed point sleeves for $D_K = 14$ mm	$D_I = 5.1$ mm $D_A = 7.7$ mm $L = 12$ mm
Fixed point sleeves for $D_K = 16$ mm	$D_I = 5.1$ mm $D_A = 9.7$ mm $L = 12$ mm

Requirements for the metal substructure	
Area of application	ventilated curtain wall facade
System	single layer system
Alignment of support profiles	vertical
Alloy	EN AW 6060 or EN WA 6063 according to DIN EN 755-2
Tensile strength	$R_m = 245$ N/mm ²
Yield point	$R_{p02} = 160$ N/mm ²
Width/thickness substructure field centre/end field	40 mm/2 mm
Width/thickness substructure jointing	90 mm/2 mm
Max. deflection of substructure	1/300
Max. panel deflection	1/100
Profile butt joints	not in panel area

Mounting materials	Shearing off $F_{0,d}$ [kN]	Extrac $F_{Z,d}$ [kN]		
		middle	on edge	corner
Rivets 5xL mm, K14 or K16 with fixed point sleeve $t_{min} = 2 \text{ mm}$ $d_{L,FZ} = 7.7 - 8.0 \text{ mm}$ for K14 $d_{L,FZ,G} = 8 \text{ mm}$ for K16 $d_{L,FZ,G} = 10 \text{ mm}$ $d_{L,substructure} = 5.1 \text{ mm}$	$a_{min} \geq 30 \text{ mm}$	-	$a_{min} \geq 30 \text{ mm}$	$a_{min} \geq 30/100 \text{ mm}$
fibreC out of white cement	0.65	0.36	0.39	0.30
fibreC out of grey cement	0.74	0.38	0.48	0.33

a_{min} = smallest intended edge distance of the panel
 t_{min} = minimum flange thickness of the aluminium substructure
 $d_{L,FZ}$ = drill hole diameter in the panel at the sliding point
 $d_{L,FZ,G}$ = drill hole diameter in the panel at the fixed point
 $d_{L,substructure}$ = drill hole diameter in the aluminium substructure

Permissible characteristic wind load (kN/m²)

Calculation of the permissible wind loads on the facade panels for the following fixing grids:

Mounting distances	Edge distances
Horizontal x Vertical Horizontal = 400, 600 mm Vertical = 400, 500, 600 mm	30 mm < a < 100 mm

Horizontal mounting distance of 400 mm	
System	Vertical mounting distance
2 x 2	3.78 kN/m ²
2 x 3	2.26 kN/m ²
2 x n	2.57 kN/m ²
3 x 3	0.96 kN/m ²
3 x n	1.09 kN/m ²

Horizontal mounting distance of 600 mm			
System	Vertical mounting distance		
	400 mm	500 mm	600 mm
2 x 2	2.38 kN/m ²	2.16 kN/m ²	1.84 kN/m ²
2 x 3	1.51 kN/m ²	1.26 kN/m ²	1.05 kN/m ²
2 x n	1.71 kN/m ²	1.43 kN/m ²	1.19 kN/m ²
3 x 3	0.64 kN/m ²	0.51 kN/m ²	0.43 kN/m ²
3 x n	0.73 kN/m ²	0.58 kN/m ²	0.48 kN/m ²

Processing details

Equipment

- > Suitable screwing tool (bit) depending on manufacturer and screw type
- > Drilling jig
- > Spacers for joints
- > Vacuum cleaner or compressor
- > Each manufacturer's application guidelines must be observed.

Screws

- > Stainless steel facade screw with head coating
- > Dimensions depending on manufacturer and application, but recommended minimum dimensions head diameter $\varnothing 14 \text{ mm}$
- > Screw diameter $\varnothing 5 \text{ mm}$
- > Fixed point sleeve 7.7 x 5.1 x 12 mm
- > Recommended clamping area 14 - 17.5 mm

Drill holes for screws

- > On the construction site, the holes in the substructure must be drilled using a drilling jig to ensure that the drill hole, and thus the screw, is centred.
- > The drilling diameter for the substructure depends on the screw diameter.
- > Drill diameters for the substructure must be chosen according to the manufacturer's specifications.
- > Screws with drill tips are often used. In this case it is necessary to pre-drill with an appropriately smaller drill or with suitable means to ensure the centric position of the screw.
- > Usually the through holes of the panel are drilled with a diameter of $\varnothing 8 \text{ mm}$.
- > The drilling dust must be removed from the drilled hole.
- > Recommended rivets with colours specially matched to fibreC surfaces are available from diverse fastener manufacturers.
- > By specifying the standard colour used, the manufacturer will give you a suitable recommendation for the colour of the rivets. Screws in matching colours can also be obtained from Rieder.

Substructure

- > Aluminium substructure
- > Steel substructure
- > Wood substructure
- > The substructure must be adjustable in order to be able to compensate for construction tolerances and allow for a constraint-free installation.

Mounting

- > With screws on vertical or horizontal support profiles or battens
- > Each facade panel requires a fixed point, which is produced using fixed point sleeves. By default, this fixed point is located in one of the upper corners of the panels and it should be set in the same corner for each panel.
- > Rieder also recommends the use of a sliding point sleeve at the opposite corner, to ensure that the panel is supported without constraint.
- > All other holes are sliding points so that the panel can move relative to the substructure without constraint.
- > The tightening torque to be applied must be specified by the manufacturer and depends on the type of substructure and its material.
- > In any case, the tightening torque must be selected in such a way as to ensure unrestricted movement of the Rieder panel relative to the substructure.
- > When facade screws are used, a design evaluation must be carried out, in any case, that is tailored to the screw used. The static values, tightening torques and the like must be obtained from the manufacturer.
- > Separable spacers (wedges) prevent the joints from bursting out.

Jointing

Rieder recommends a joint width of at least 8 mm. The maximum joint width depends on the respective applicable national regulation.

Optional services

At the Rieder factory, the panels are cut on request to the shapes and sizes provided and the through holes for rivet mounting are prepared on the basis of the information provided by the installer.

Parameters and statics

Panel parameters fibreC	
Relevant approval	Avis Technique 2.2/14-1642_V1 (France only)
Panel thickness	13 mm ± 10 %
Raw density	2,100 kg/m ³ ± 10 %
Flexural strength	> 18 N/mm ²
Young's modulus	> 20,000 N/mm ²
Water absorption	9 % ± 10 %
Humidity expansion	0.7 mm/m

Drill data	
Panel drill hole	nominal 8 mm or as specified by the processor
Substructure drill hole	dependent on the screws and the material of the substructure
Drilling the hole in the substructure	using a drill jig

Screw data	
Description	stainless steel facade screws with painted or powder-coated head
Screw material	A4 stainless steel, material number 1.4401, AISI 316
Screw dimensions	nominal Ø 5, length: depending on the substructure used
Head diameter	varies depending on the manufacturer and type of facade screw
Clamping area	13.5 mm to 17.5 mm

Requirements for the substructure	
Area of application	ventilated curtain wall facade
System	one layer or double layer system
Alignment of support profiles	nominal vertical
Width/thickness substructure field centre/end field	40 mm to 60 mm
Width/thickness substructure jointing	80 mm to 120 mm
Max. deflection of substructure	1/300
Max. panel deflection	1/100
Profile butt joints	not in panel area

General Information

Notes

This publication contains basic descriptions and information about fibreC products. Any description of the product characteristics or other explanation of the goods is not to be understood as a guarantee or warranted characteristic. All instructions as well as technical and drawing information correspond to the current technical status and are based on Rieder's experience. The service of Rieder Sales GmbH generally includes the product. Substructures can also be offered depending on the project. The applications described are examples and do not take into account the special circumstances of individual cases. The information and suitability of the product for the intended purposes must be examined in each case, for each country and for each project.

No liability is assumed for correctness, completeness and topicality despite careful scrutiny. This also applies in particular to printing errors and subsequent changes to technical specifications. We refer you to the provision in the contract to be concluded, which takes precedence over the information given here.

For reasons of readability, the masculine form was used in the text. We are nevertheless referring to members of all genders.

For more information about sales terms, availability, prices etc. please contact your local Rieder sales partner or contact Rieder directly. The up-to-date version of the technical documentation can be found at www.rieder.cc.

Information about statics

The basis for the static data in this printing unit are the regulations and standards valid at the time of preparation, in particular: DIN EN 1991-1 Load assumptions for buildings (Eurocode 1) approval Z-31.4-166 glassfibre reinforced concrete panel "fibreC" according to DIN EN 12467.

The services of Rieder Sales GmbH do not normally include statics calculations. The example calculations given do not dispense with the project-related individual examination by a structural engineer. Project-related technical design assessments are always required (this includes technically correct execution, a static calculation, building physics assessment, etc.). Rieder assumes no liability for the statics. Project-related details are not included in the data. The respective country guidelines must be observed.

Note on facade soffits and roof applications: the maximum grid spacing is limited to 400 mm for technical reasons.

Protection of foreign copyrights

The company endeavours in all publications to observe the copyrights of the graphics, photos and texts used, to use graphics, photos and texts created by Rieder itself or to use licence-free graphics, photos and texts. If there is a graphic, photo or text on one of the pages that is not marked but is protected by a third-party copyright, Rieder has been unable to determine the copyright. In the event of such an unintentional copyright violation, Rieder will remove the object in question or label it with the appropriate copyright as soon as the company has been notified of the violation.

All information, company logos, texts, graphics and pictures are subject to copyright. They are the property of Rieder Sales GmbH, unless other reservations of title apply. Further processing and use in media are only permitted with the prior written consent of Rieder.

Photos, visualisations and text

Daniele Ansidei, Ditz Fejer, Helene Binet, Maggie Janik, kirchner&kirchner, Rasmus Norlander, Sigurd Steinprinz, ACMS Architects, Adeline Seidel, Franziska Leeb



Installation by artist Ron Terada

Rieder Sales GmbH

Mühlenweg 22 | 5751 Maishofen | Austria
+43 6542 690 844 | office@rieder.cc | www.rieder.cc

Rieder Faserbeton-Elemente GmbH

Bergstraße 3a | 83059 Kolbermoor | Germany
+49 8031 901 670 | office@rieder.cc | www.rieder.cc

Rieder NORAM Inc.

N3840 2nd ST | WI 54895 Weyerhaeuser | USA
+1 888 573 8069 | sales.usa@rieder.cc | www.rieder.cc



RIEDER