



loommi

step beyond

In modern architecture, lighting fixtures always served as the jewels, adding refinement and emotion to interiors. Their forms and luminosity bring out the essence of each space. At Bomma, we explore this deeper dimension through innovative approaches that move the standards of our craft, as well as our products a step beyond.

Bomma proudly builds on a traditional glassmaking craft, blending it with original in-house developed technologies. We strive for great design and modern simplicity, taking production to the very limits of glassmaking. Take a step beyond your expectations of contemporary glass design and craft.

Jakub Polláď & Václav Mlynář
of Studio deFORM
Bomma Art Directors

bomma pro

Bomma PRO platform for professionals allows a customized solution for different projects. Get access to trade pricing or simply get in touch with Bomma team. Find out more at our website.

pendulum
limbo
peleles
lens
umlora
tim
orbital
phenomena
shilori
lantern
tied-up romance
sooibo
disc
dark & bright star



pendulum



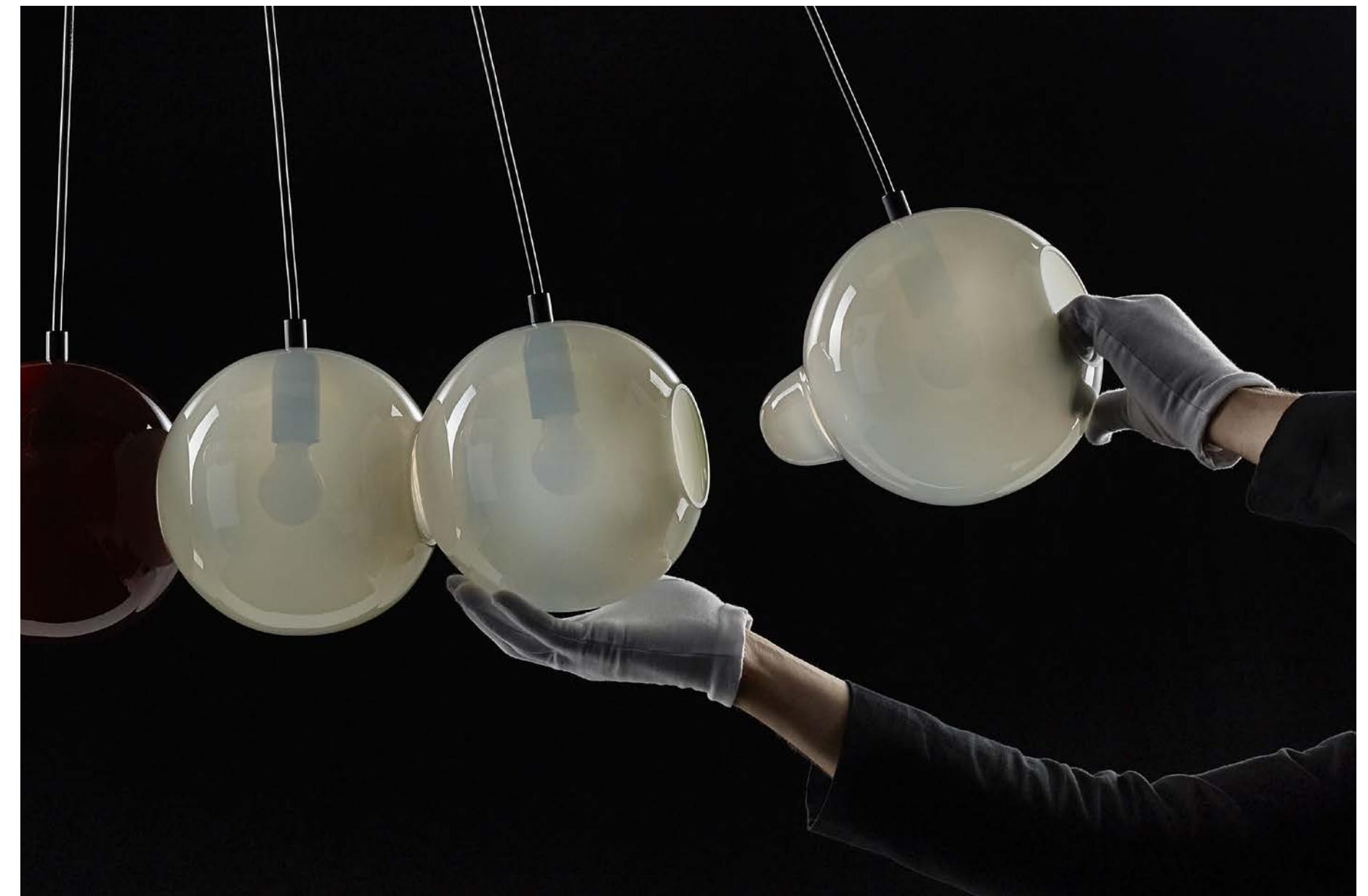

pendulum

The timeless play of balance and energy.

Although inspired by Newton's cradle, demonstrating the conservation of momentum and energy, this glass version should be handled with care. The playful and highly variable collection provides space for your own creativity. Physics, aesthetics and craft all come together to remind us that everything is in perpetual motion.

Design by Studio deFORM

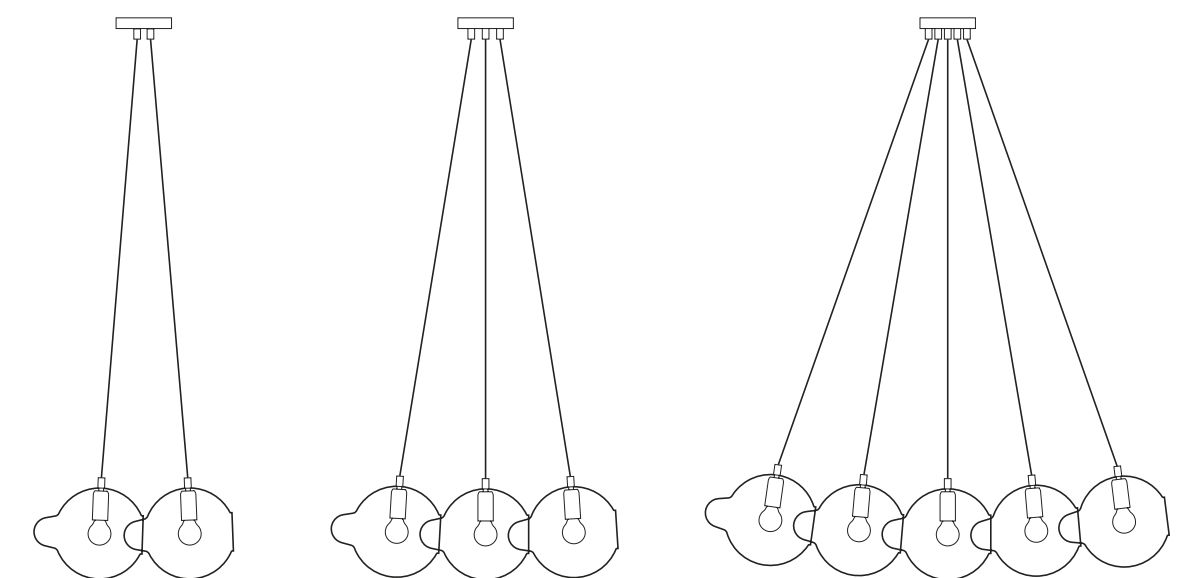

2 position

→← 415
↑↓ 210

3 position

→← 600
↑↓ 215

5 position

→← 970
↑↓ 240

glass options

- light grey
- dark red
- pink
- pigeon blue

fitting options

- black
- white

The glass parts of Pendulum are mouth-blown thus the intensity of color and gradient may slightly vary.

lolimp







blimp

The unbearable lightness of glass.

This stunning massive crystal cloud floats in space with the lightness of a zeppelin. Bomma master glassmakers created Blimp as the largest piece blown into form, at once monumental and airy. This graceful giant is a testament to human ingenuity and craftsmanship.

Design by Big-Game

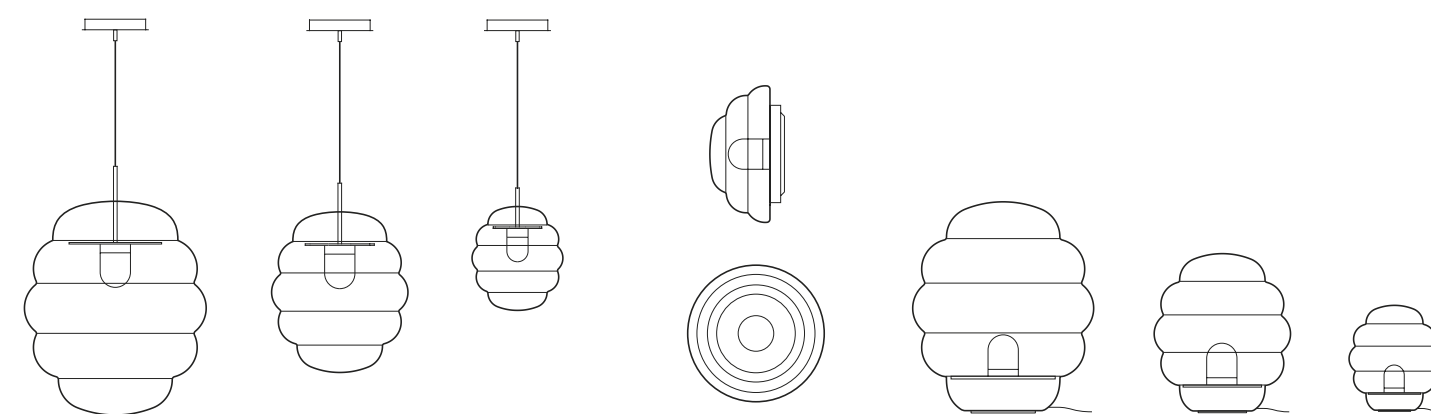

pendant
large

→← 600
↑↓ 770

pendant
medium

→← 450
↑↓ 625

pendant
small

→← 300
↑↓ 415

wall & ceiling
lamp

→← 450
↑↓ 450

floor lamp
large

→← 600
↑↓ 695

floor lamp
medium

→← 450
↑↓ 535

floor lamp
small

→← 300
↑↓ 350

glass options

- clear
- amber

fitting options

- black

The glass parts of Blimp are mouth-blown thus the intensity of color may slightly vary.



pelololes





pebbles

Keepsakes of treasured memories.

Smooth pebbles from summer beach, or as a reminder of someone special. Their diverse shapes and colors inspired this lighting collection that lets you to create distinctive combinations. String the hand-blown glass elements just like colorful beads, connected by their interior light source.

Design by Boris Klimek

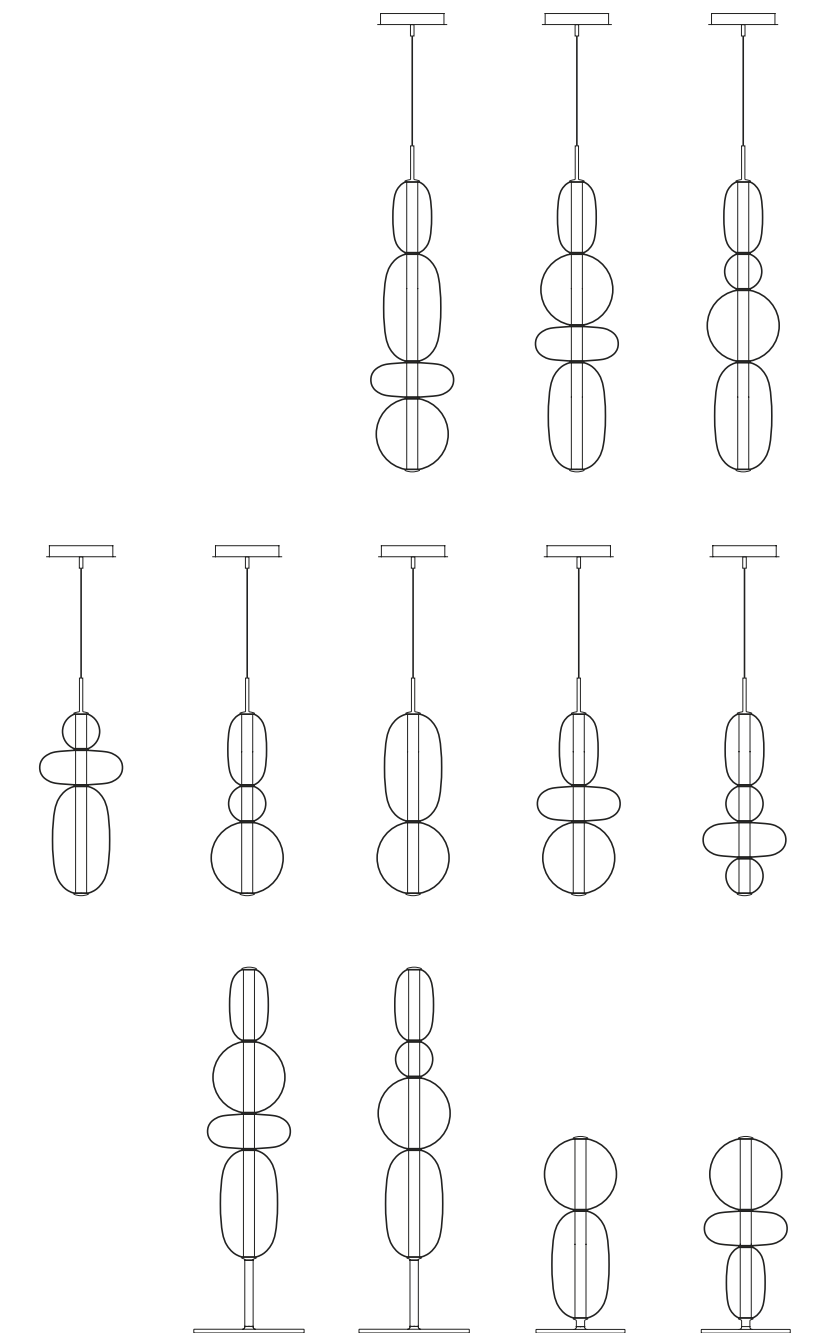

glass options
 • black
 • light grey
 • white
 • green
 • red

pendant
large
 →← 300
 ↑↓ 1182

pendant
small
 →← 300
 ↑↓ 790

floor lamp
large
 →← 400
 ↑↓ 1326

floor lamp
small
 →← 322
 ↑↓ 712

fitting options
 • black

The glass parts of Pebbles are mouth-blown thus the intensity of color and gradient may slightly vary.

lens







lens

The perfect optics of pure crystal.

Light refracted through a lens is the fundamental principle of optics. Here, two lenses harmoniously encapsulate their interior source, playing a symphony of lights. Classic clear crystal is offset by a single color that highlights its refraction. A hypnotic design, asking only unique composition and arrangement.

Design by Studio deFORM

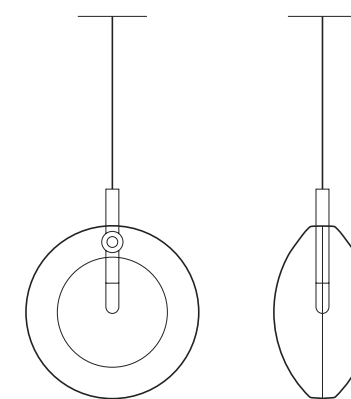

pendant
 →← 160
 ↑↓ 195

glass options
 • clear
 • white
 • red

fitting options
 • brushed brass

The glass parts of Lens are hand-painted thus the intensity of color may slightly vary.



umloro





umbra

There is no shadow without light.

Inspired by the relationship between geometric objects and their shadows, the Umbra collection features elegant pendants in sophisticated detail. Its metal plate derives from the perfectly elliptical shadow cast by a side-lit ball, mirroring the colorful mouth-blown crystal piece.

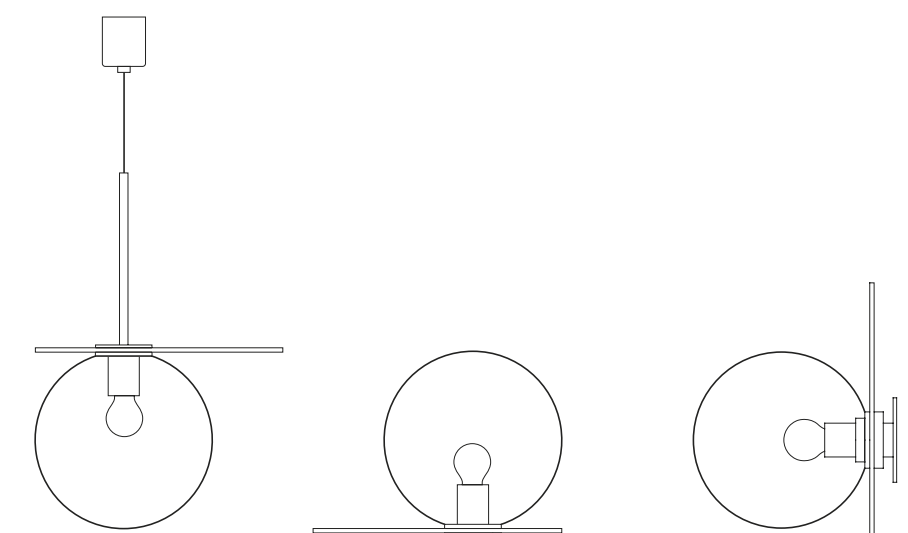

pendant
→← 350
↑↓ 470

table lamp
→← 350
↑↓ 270

wall & ceiling lamp
→← 350
↑↓ 287

glass options
• smoke
• pink
• blue
• clear
• light grey

fitting options
• gold

Design by Dechem Studio

The glass parts of Umbra are mouth-blown thus the intensity of color and gradient may slightly vary.

tim







tim

Purity, clarity and mastery.

These monumental pieces marked Bomma's entry to the world of top-level lighting design and set us on our path. Their sheer weight and size reaches the limits of what can be achieved by free-form mouth blowing. Unique world-wide and displaying the subtle variations of hand craft, these impressive lights embody design simplicity and glassmaking mastery.

Design by Olgoj Chorchoj

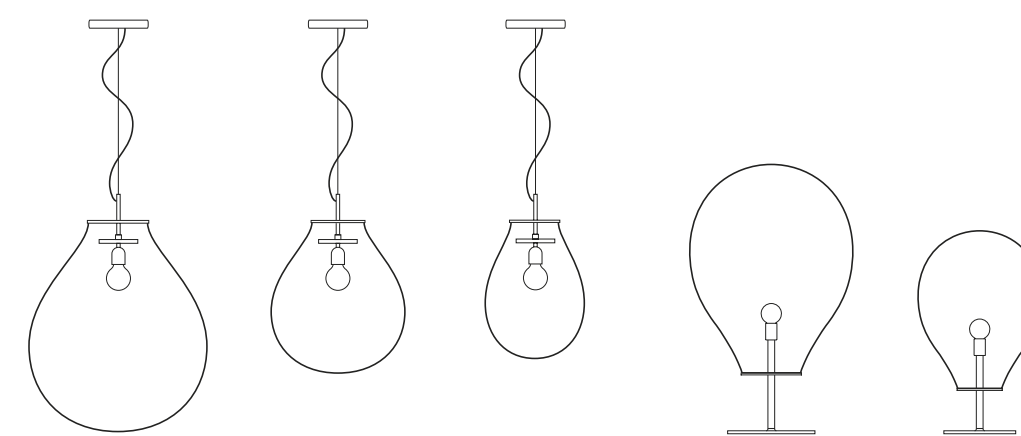

pendant
large
→← 600-700
↑↓ 715-915

pendant
medium
→← 450-550
↑↓ 515-715

pendant
small
→← 300-400
↑↓ 465-565

floor lamp
large
→← 600-700
↑↓ 1000-1100

floor lamp
medium
→← 400-500
↑↓ 800-900

glass options
• clear
• smoke grey

fitting options
• silver
• copper
• black

The glass parts of Tim are mouth-blown without a mould thus the size and shape may slightly vary.

orbital









orbital

Crossing galactic paths.

Orbital paths of multicolored celestial bodies with hypnotically glowing cores. This ingenious design of mouth-blown glass lenses, held together by a metal mounting, creates a fascinating visual experience from different angles.

Design by Studio deFORM

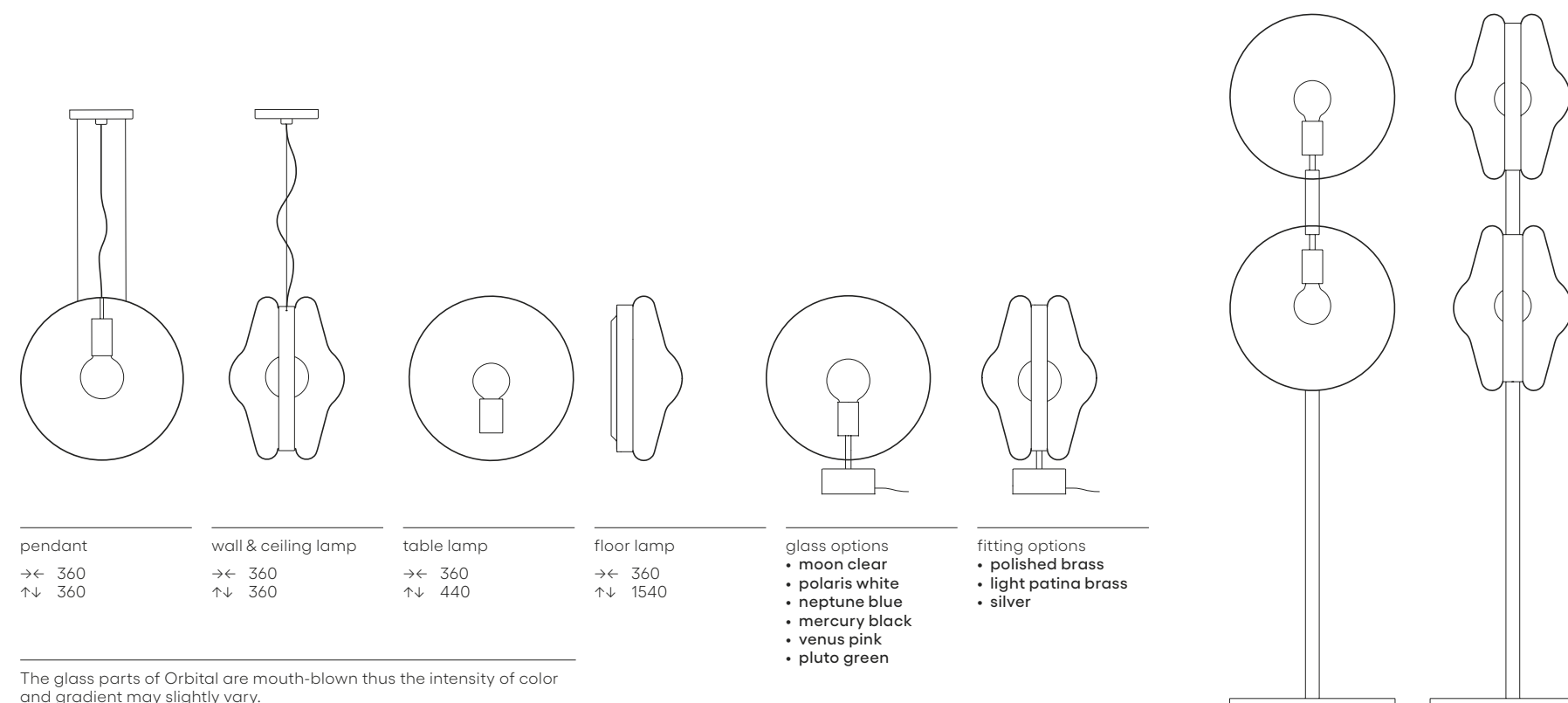

phenomena







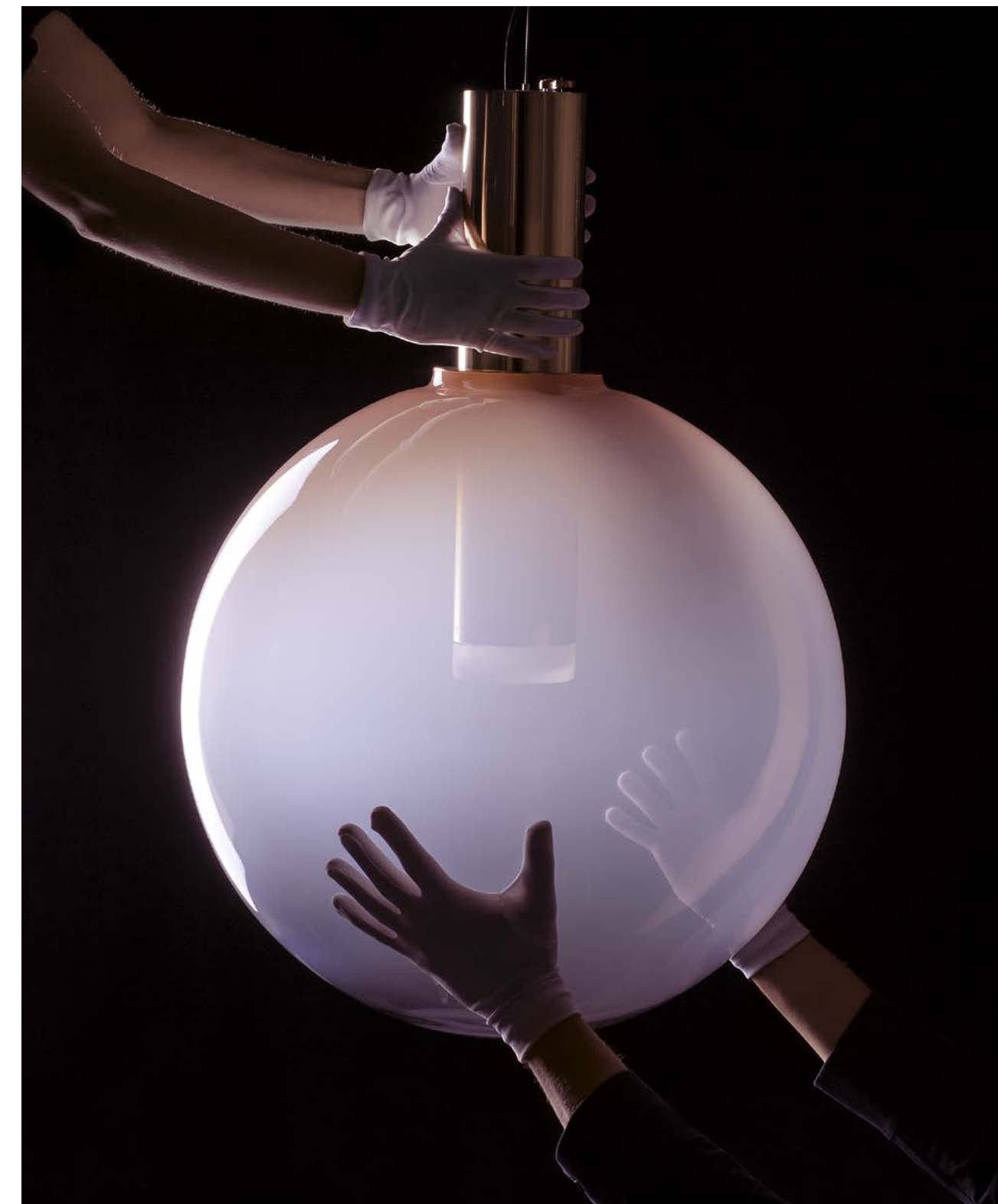

phenomena

Transient images of the eternal.

Plato's phenomena (appearances) are the ideal, inherently unreal and unattainable forms. In this case, they appear as a circle, a triangle, a rectangle and an oval. The distinct metal mounting holds the elusive gradient glass – a material so difficult, yet versatile, strong, yet fragile.

Design by Dechem Studio

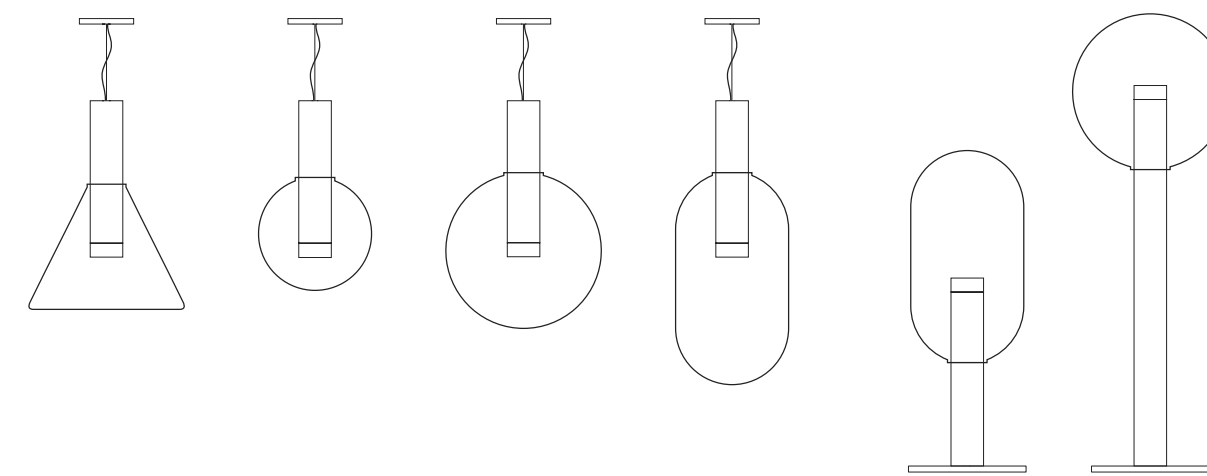

pendant
→← 550 ↑↓ 680

glass options
• smoke grey
• clear cut pattern

fitting options
• silver
• gold

pendant
→← 400 ↑↓ 650

glass options
• ferrari red
• smoke grey
• clear cut pattern

fitting options
• silver
• gold

pendant
→← 550 ↑↓ 800

glass options
• flamingo pink
• smoke grey

fitting options
• silver
• gold

pendant
→← 400 ↑↓ 1000

glass options
• mint green
• smoke grey
• clear cut pattern

fitting options
• silver
• gold

floor lamp
small
→← 400 ↑↓ 1020

glass options
• mint green
• smoke grey

fitting options
• gold

floor lamp
large
→← 550 ↑↓ 1600

glass options
• flamingo pink
• smoke grey

fitting options
• gold

The glass parts of Phenomena are mouth-blown thus the intensity of color and gradient may slightly vary. The clear crystal Phenomena is finished with finely cut geometric patterns.



shiloori

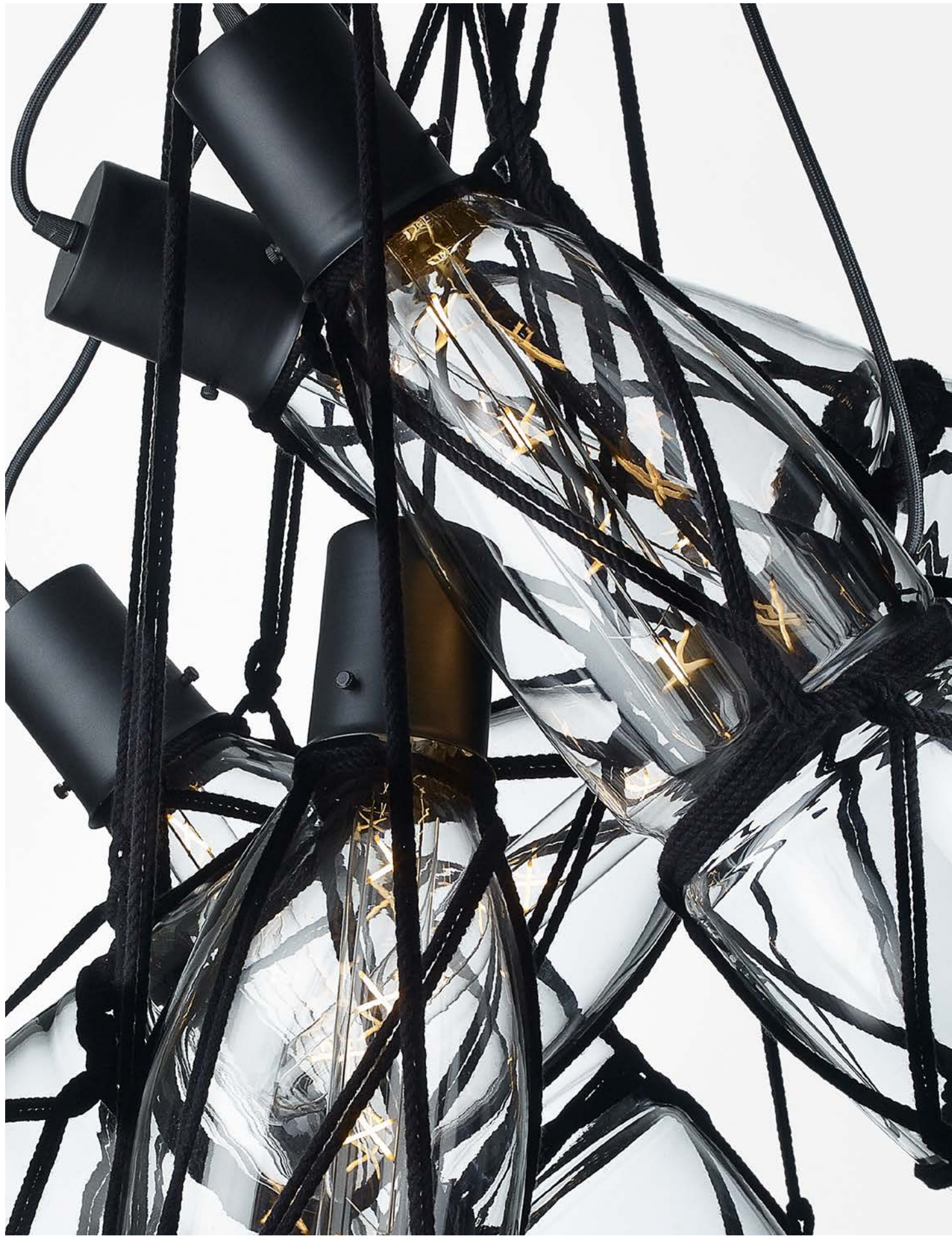



shibari

The secret language of knots.

Shibari is not just the technique of tying up objects with ropes, it is a method of communication within a hidden system of lines and loops. The Japanese call it Kinbaku: the beauty of tight binding. This sophisticated collection places crystal centerpieces amidst the knots to draw our attention and create variable compositions.

Design by Kateřina Handlová

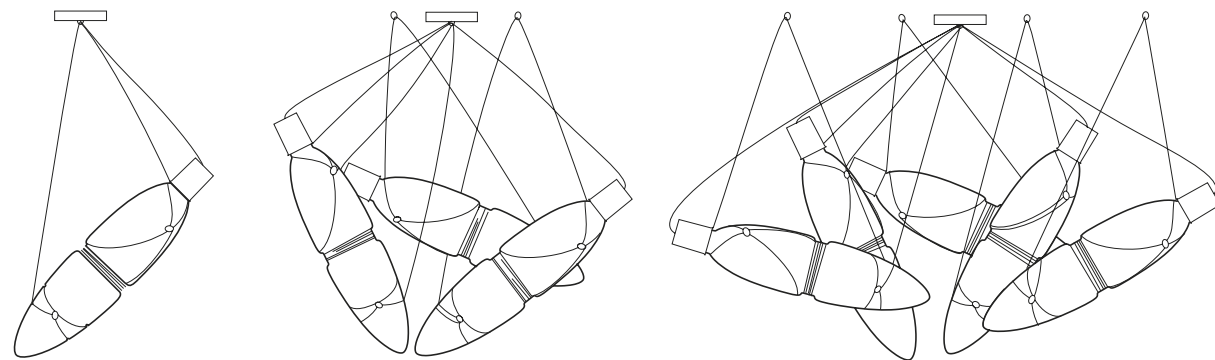

pendant
1 position
→← 450
↑↓ 600

pendant
3 position
→← 550
↑↓ 750

pendant
5 position
→← 900
↑↓ 950

fitting options
• black

The glass parts of Shibari are all mouth-blown by our craftsmen, so individual pieces may vary slightly.



lantern





lantern

When glass embodies paper.

Combining an ancient shape with crystal, this Lantern seems ephemeral. Almost invisible, yet strong in design, it is simultaneously traditional and contemporary.

Design by Jan Plecháč & Henry Wielgus

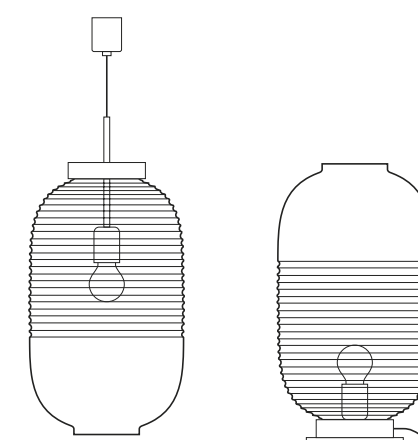

pendant
→← 225
↑↓ 505

table lamp
→← 225
↑↓ 415

glass options
• clear
• white
• smoke grey

fitting options
• light patina brass
• polished brass
• black
• white

The glass parts of Lantern are mouth-blown thus the intensity of color and gradient may slightly vary.

tied-up
romance







tied-up romance

Beauty in contradiction.

The provoking aesthetic of bondage highlights both the fragility and the solidity of glass. Crystal elements are tightly bound in meticulously crafted leather and horsehair. Tied-Up Romance celebrates the world of contradictions and the fluid essence of glass.

Design by Kateřina Handlová

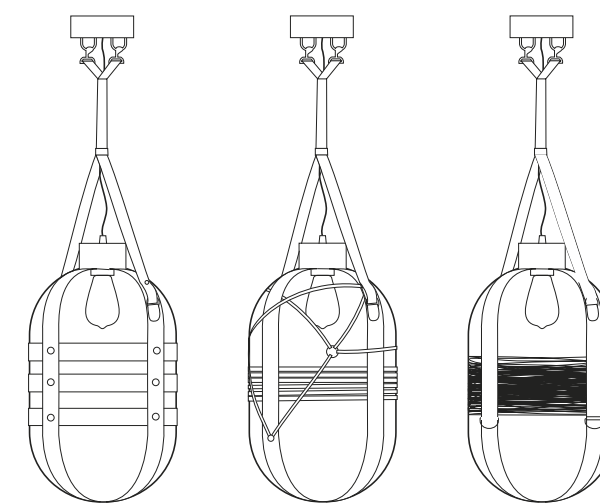

pendant
type A
→← 250
↑↓ 480

pendant
type B
→← 250
↑↓ 480

pendant
type C
→← 250
↑↓ 480

fitting options
• black

The glass parts of Tied-Up Romance are all mouth-blown by our craftsmen, so individual pieces may vary slightly.

SOOPO







soap

The magic of iridescence.

Varying colors, transparency and continuously changing shapes – the characteristic features of soap bubbles, inspired this collection. Lighted, their metallic sheen magically transforms to iridescent and translucent. Each piece is mouth-blown without a mold, producing an original in both shape and color.

Design by Ota Svoboda

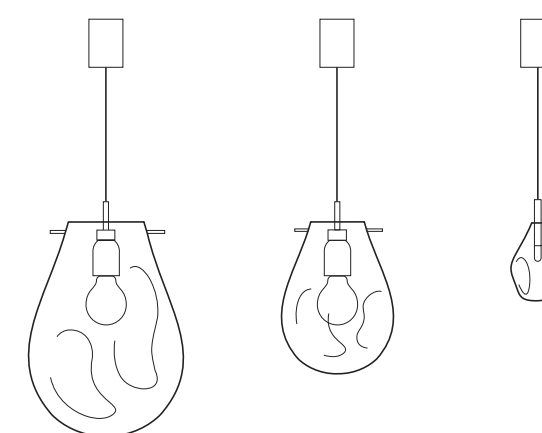

pendant large
→€ 190–290
↑↓ 290–390

glass options
• silver
• gold
• blue
• purple
• green

fitting options
• brushed stainless steel

pendant small
→€ 140–240
↑↓ 190–290

glass options
• silver
• gold
• blue
• purple
• green

fitting options
• brushed stainless steel

pendant mini
→€ 100
↑↓ 180

glass options
• silver
• gold
• blue

fitting options
• anthracite

The glass parts of Soap are mouth-blown without a mould thus the shape, size and intensity of color may slightly vary.



olisc



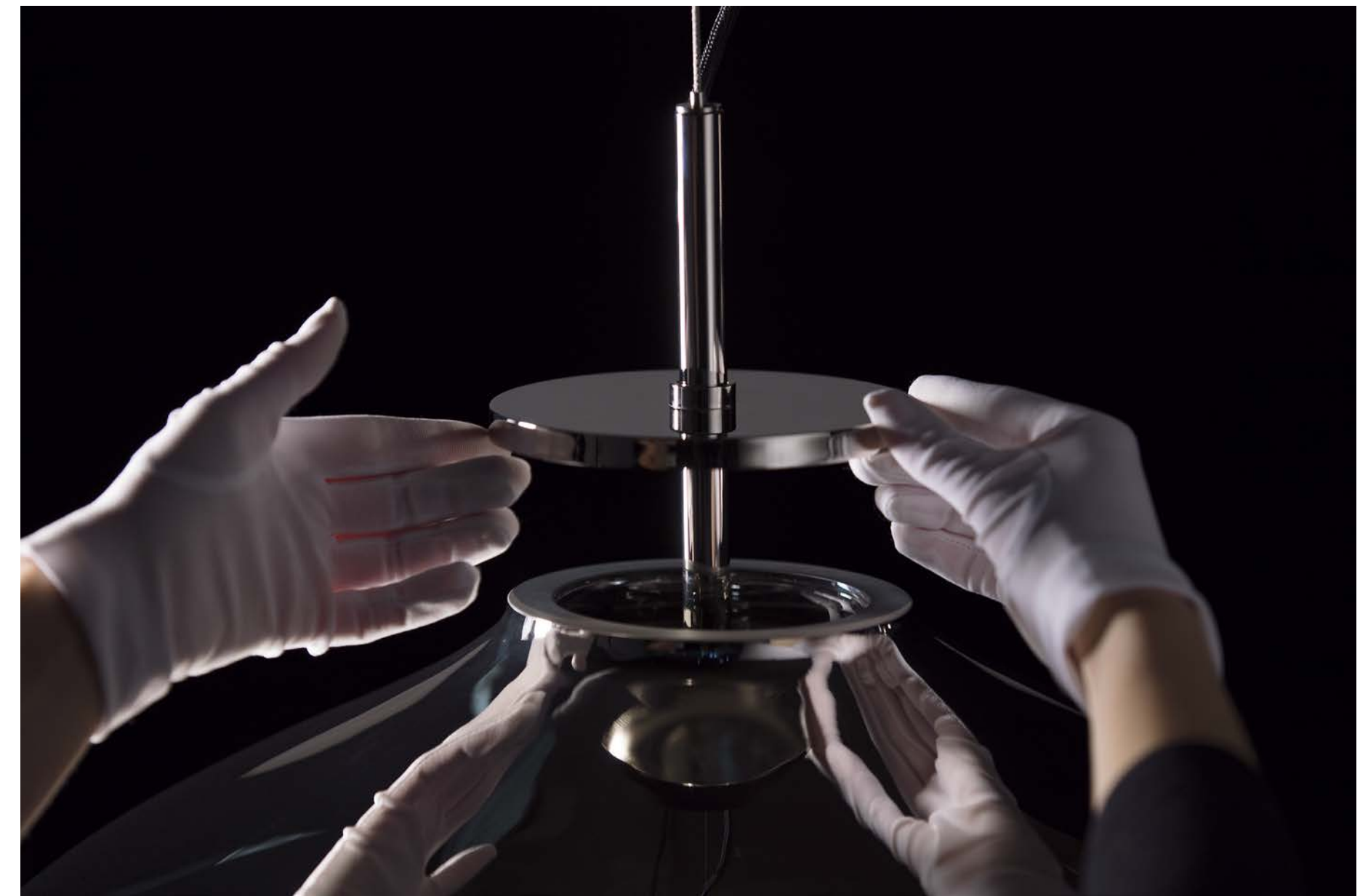

disc

A visit from the outer space.

These pieces take the idea of extremely large glass volumes to its next level. Blown against a mould, the Disc pendants combine crystal and metal with minimalistic design, fine materials and precise details. Their shapes seem familiar and close, the gleaming surfaces reflect our world in a fresh perspective.

Design by Olgoj Chorchoj

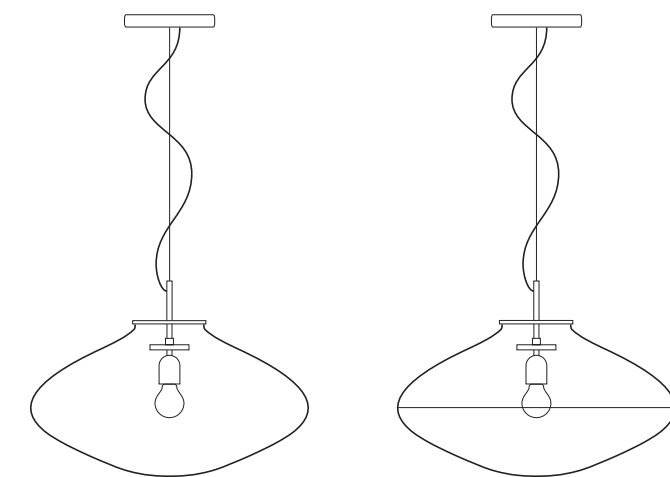

pendant
clear
→← 548
↑↓ 315

fitting options
• black
• silver
• polished copper

pendant
silver
→← 548
↑↓ 315

fitting options
• silver

pendant
copper
→← 548
↑↓ 315

fitting options
• polished copper

The glass parts of Disc are mouth-blown. The colored Discs are then metal-coated, thus the intensity of color may slightly vary.



dark &
bright star





dark & bright star

The endless duel of light and darkness.

Like distant stars, these seemingly small lighted objects are powerful in both their design and craft. The light source is placed within a mouth-blown piece, the shining center of a precisely cut crystal star. Unique as a solitaire and even stronger in constellations.

Design by Dechem Studio

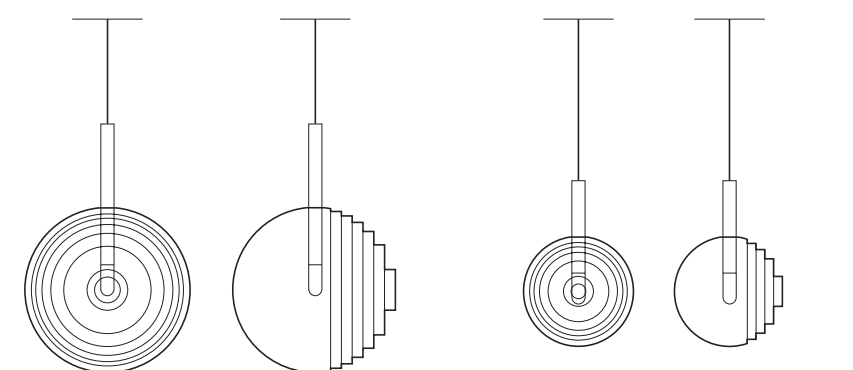

pendant
large
→← 150
↑↓ 225

pendant
small
→← 100
↑↓ 150

glass options
• dark
• bright

fitting options
• anthracite
• brushed brass

The stars are mouth-blown, then defined by precise cut.

chandeliers

Bomma crystal pendants are now available with mounting canopies that allow spectacular chandelier compositions.

∅ 400
3 pendants



∅ 620
7 pendants

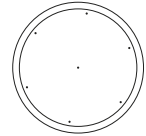

∅ 950
11 pendants

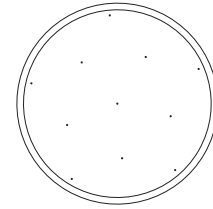

380 x 1430
10 pendants



∅ 400
3 pendants



∅ 400
6 pendants



∅ 620
9 pendants

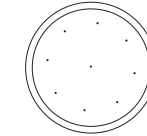

∅ 620
12 pendants

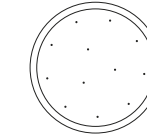

∅ 950
26 pendants

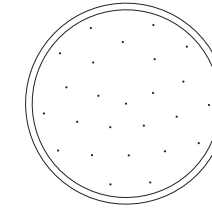

380 x 1430
26 pendants

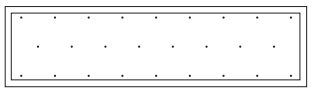

umbra

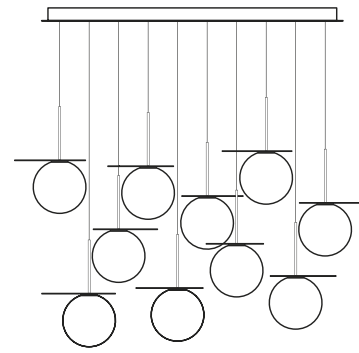
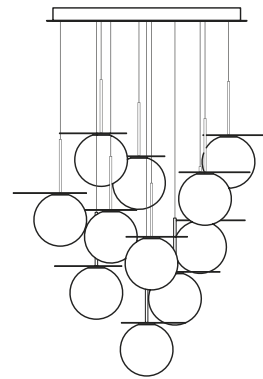
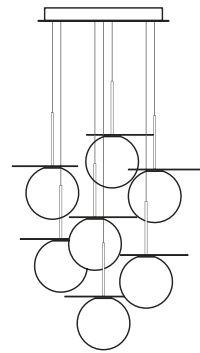
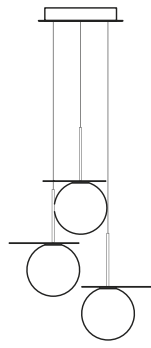

dark & bright star

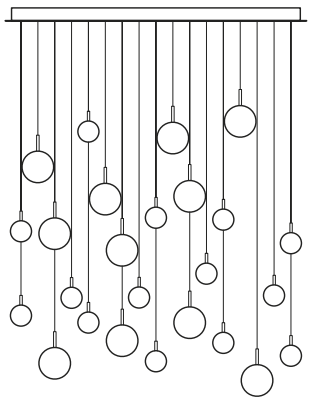
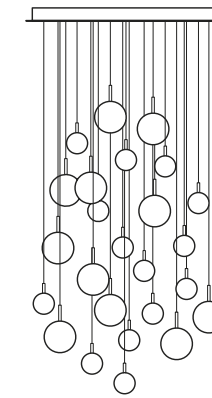
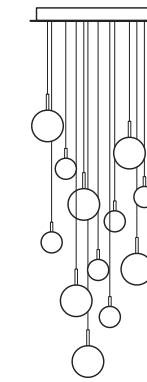
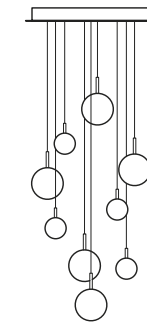
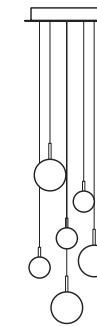
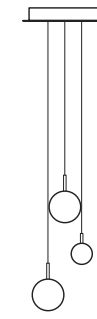

soap

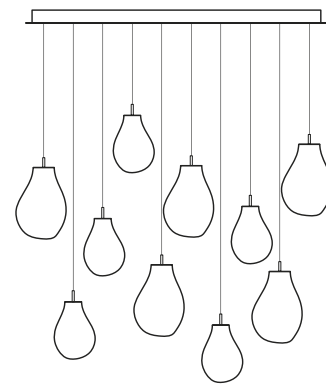
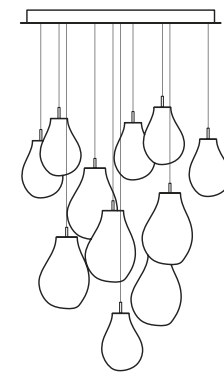
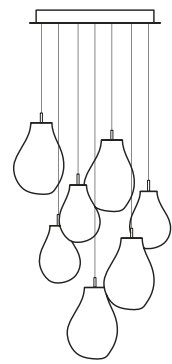
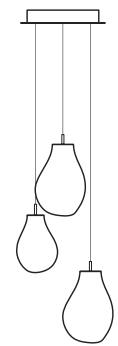

soap mini

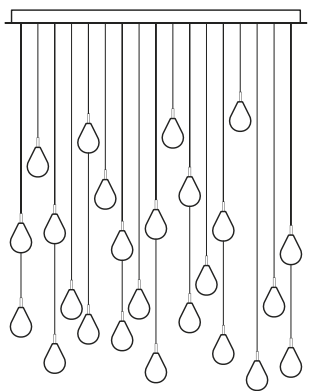
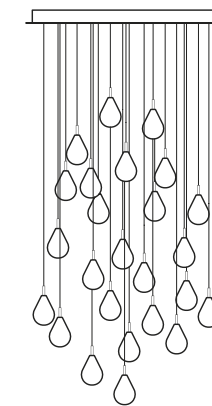
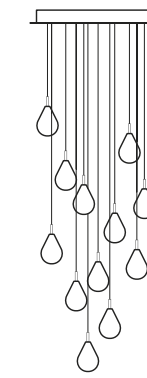
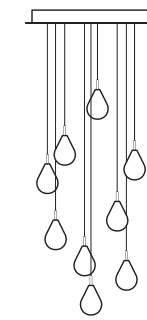
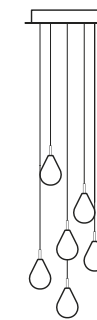
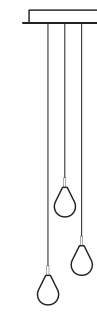

lantern

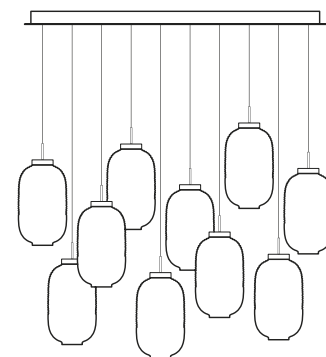
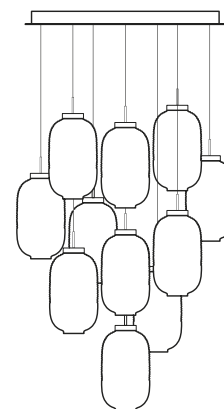
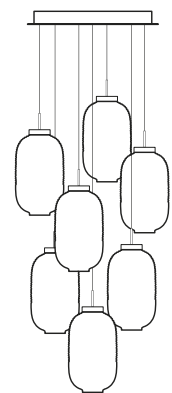
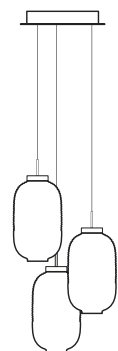

lens

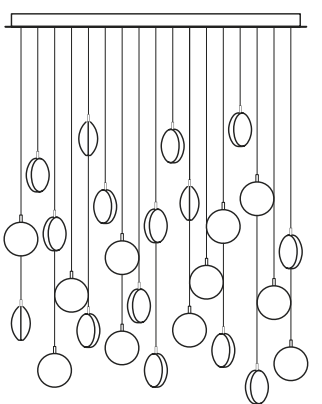
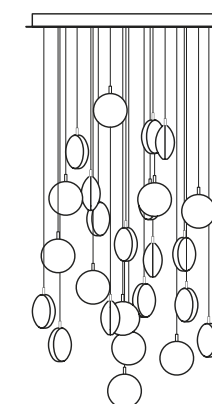
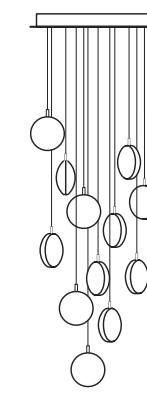
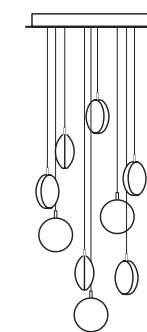
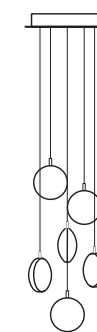
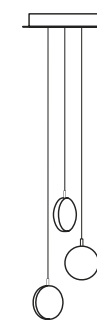

about

Founded in 2012, Bomma continually moves traditional Czech glassmaking craft to a new level. With centuries of glassmaking tradition in East Bohemia, we now take advantage of a rich pool of talent and top-level skills. Instead of simply maintaining these traditions, Bomma sets today's standards of glassmaking.

Our master craftsmen are backed by some 300 enthusiastic team members in an ultra-modern facility featuring in-house technology. We produce 6 tons of refined extra-clear crystal each day. The high-tech original machinery for precise melting and measuring allows our craftsmen reach their maximum potential of manual production, and lends itself to otherwise unachievable customization and color-blending.

Bomma know-how opens its doors to designers who continually challenge our technical teams and craftsmen. Our emphasis on contemporary design, outstanding glass quality and detail brought many awards and world-wide recognition in a surprisingly short time, leading to our exceptional position in the market, as well as countless interesting projects and collaborations.

For this we thank our ancestors, teams and especially our clients. We see our success as an obligation to move forward. Join us on this exciting journey.

Step beyond.

BOMMA
Zámecká 1177
58291 Světlá nad Sázavou
Czech Republic

+420 569 453 149
info@bomma.cz
www.bomma.cz

Creative Directors Studio deFORM

Image Photo Petr Krejčí, Martin Chum
Product Photo Martin Chum, Salim Issa, Anna Pleslová
Graphic Design Studio Najbrt

Instagram bomma_cz
Facebook bommacz
YouTube BOMMA Lighting

BOMMA 2019

loomma

