

MA / U
Studies

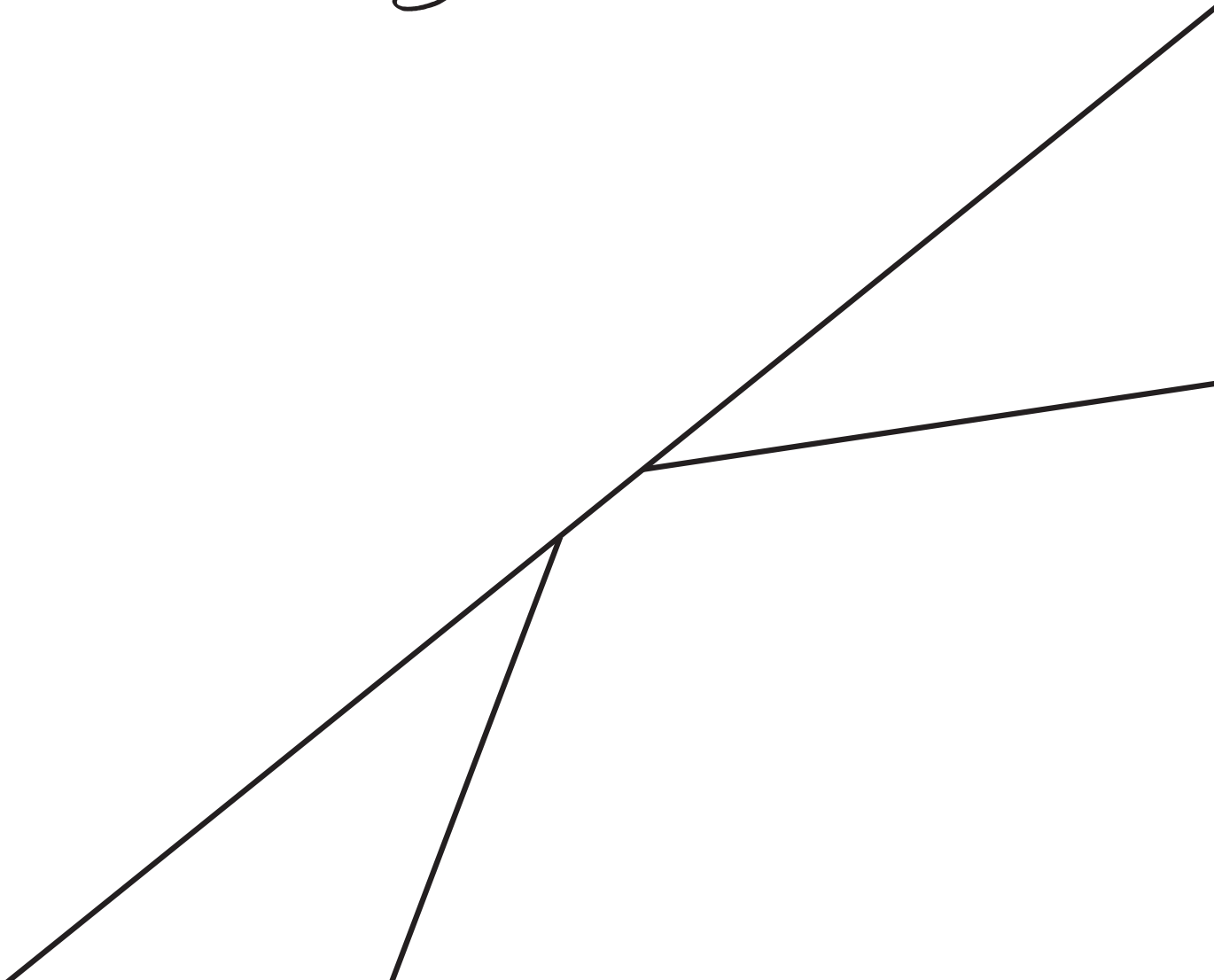

NOV

ELT

IES

'18

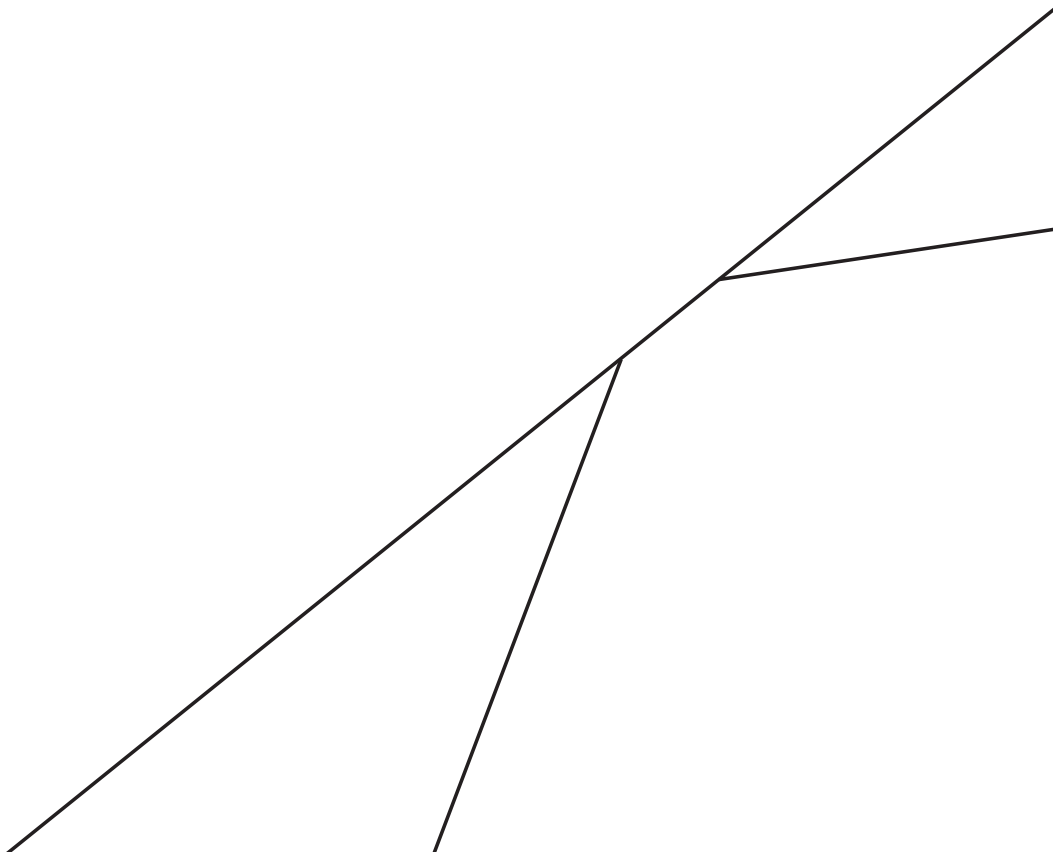

The R.I.G. Modules shelving system is able to transform into any number of solutions suitable for the living room, study, entrance hall and dining room: television stands, side tables for lighting, low tables next to sofas, credenzas and low height bookcases.

L I V I N G





G



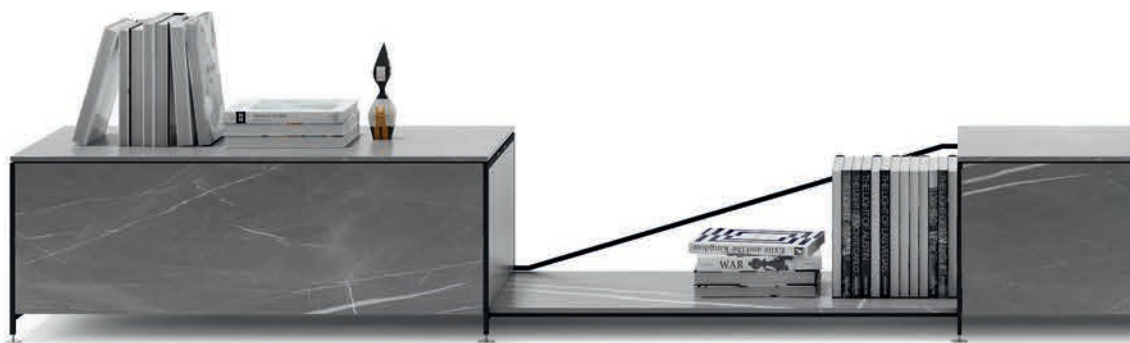

















TECHEN

A shelving unit is paired with advanced technical solutions for the kitchen to offer an open storage system for provisions, glassware, cookware and kitchen utensils.

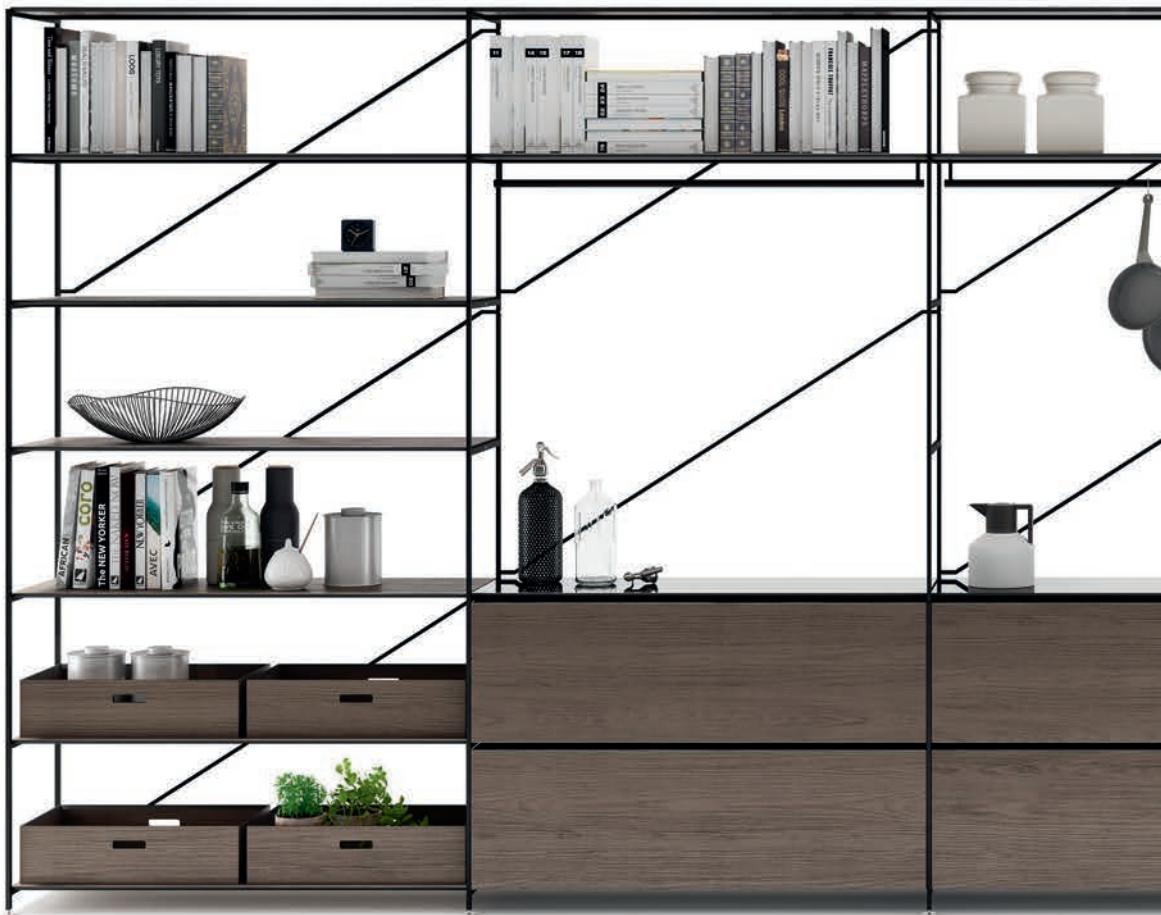



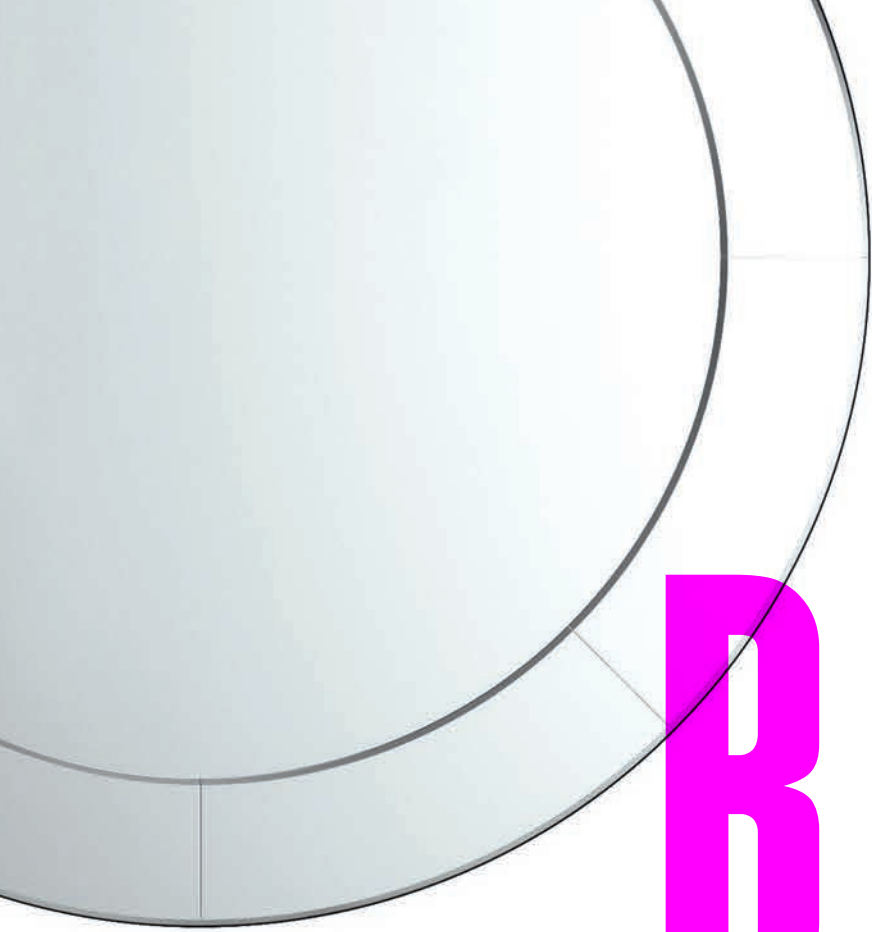

BAT



HRROOM

The R.I.G. Modules system is able to create original solutions for sophisticated bathrooms.

The solid construction of each module and the clean geometric lines of the setup are advantageous when working with natural stone and metal or with freestanding or wall-mounted units.

The system is completed with two types of mirrors: self-supporting or wall-mounted.



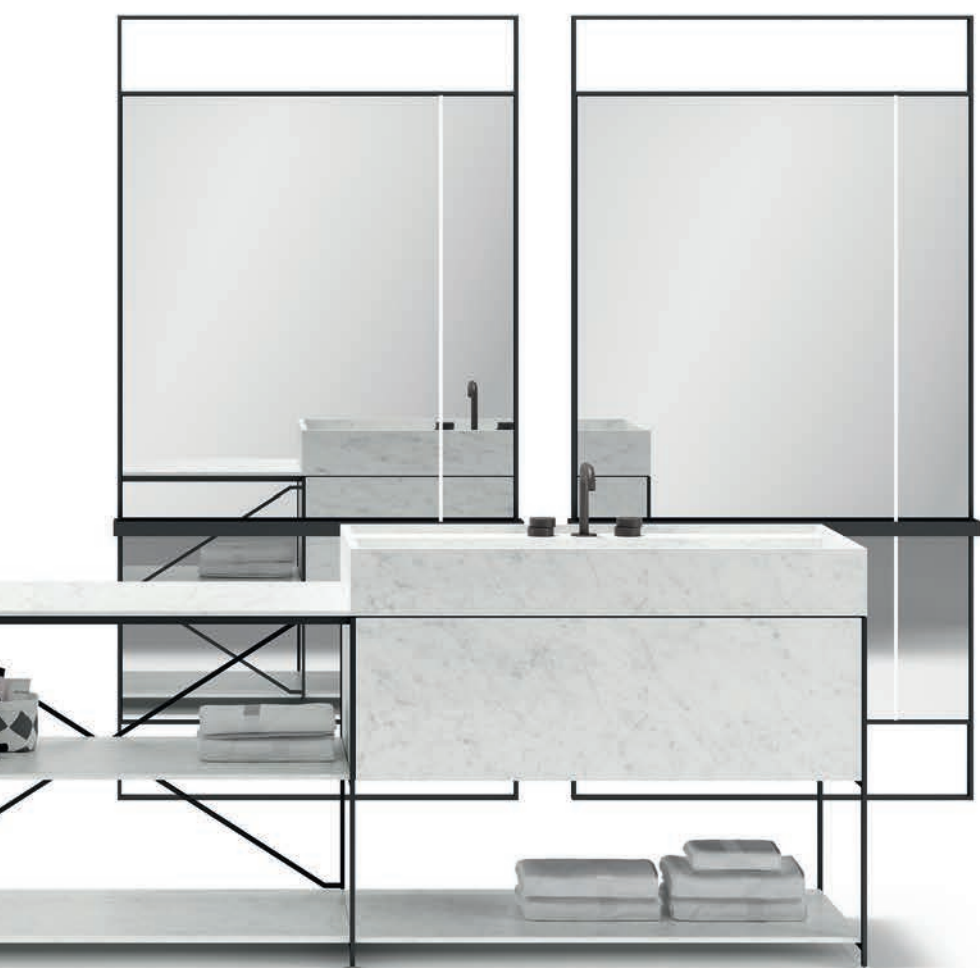

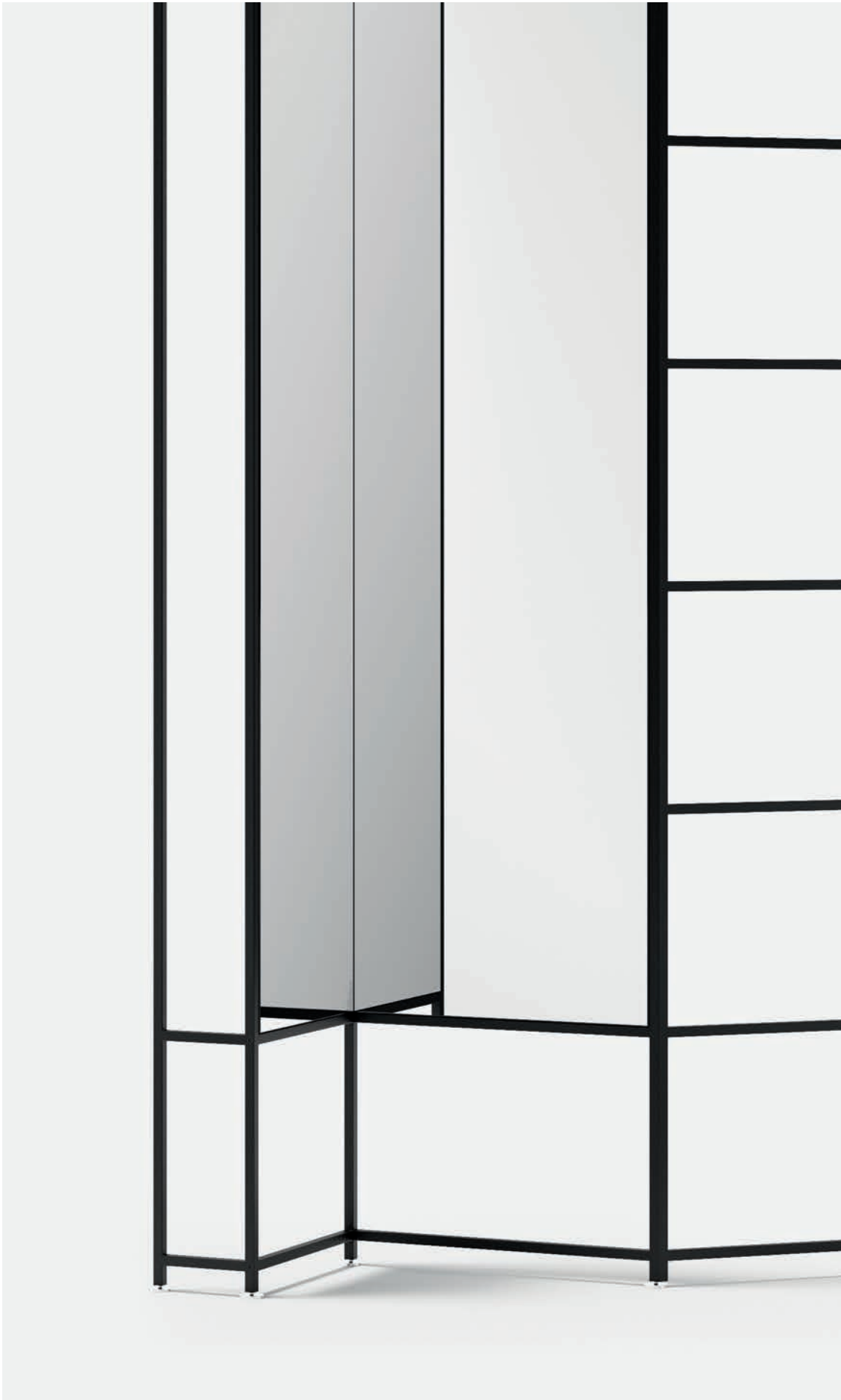



R.I.G. MODULES MIRRORS

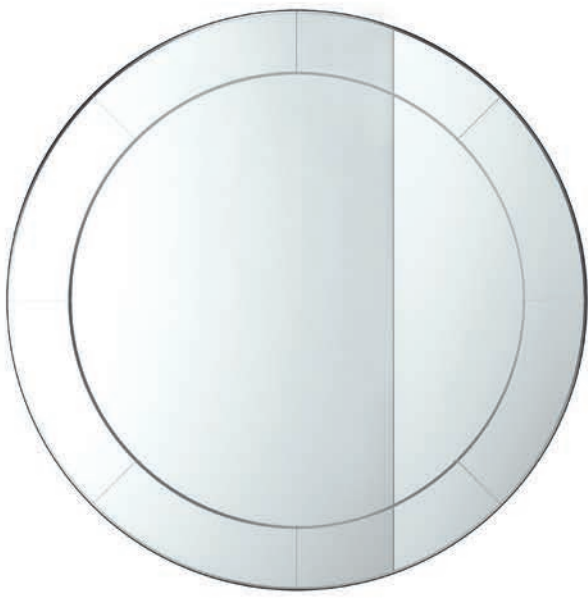

The R.I.G. Modules lends itself to wardrobe solutions to create a simple and efficient way to store clothing in an open and uncomplicated setup complete with drawers, mirrors, hangers and essential elements common to traditional walk-in closets.

WARDROBE





ROBE











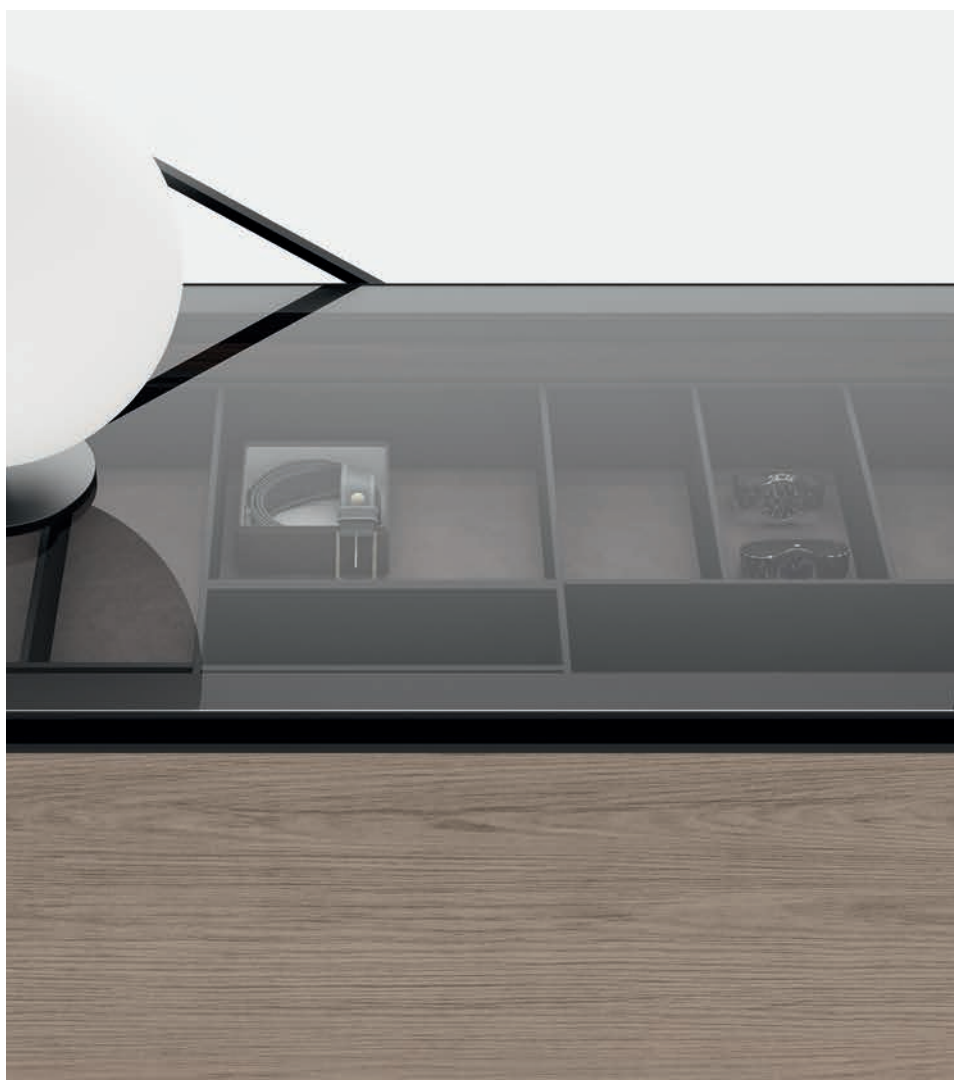

INDEX

PAG. 4	R.I.G. MODULES
PAG. 36	R.I.G. BENCH
PAG. 44	T.T.A. TABLE
PAG. 54	N.E.T. TABLE
PAG. 64	C.O.P. STORAGE SYSTEM
PAG. 75	TECHNICAL INFORMATION

Founded in 2012 in Copenhagen by the designer Mikal Harrsen and under consultancy of architect Adam Hall, MA/U Studio can be summed up in a few simple principles: clean lines, functionality and constant research without compromise on quality. Over the years, these objectives gave birth to the production of multifunctional furniture that reinterprets Scandinavian tradition in a contemporary way, being attentive to the expectations of global markets and focusing on space flexibility. A cultural trend increasingly crossing boundaries between professional and domestic interiors and favouring furniture pieces able to change and adapt to different spaces.



**R.I.G.
MODULES**

**RUDIMENTARY
INTERIOR
GEOMETRY**

DESIGN BY MIKAL HARRSEN

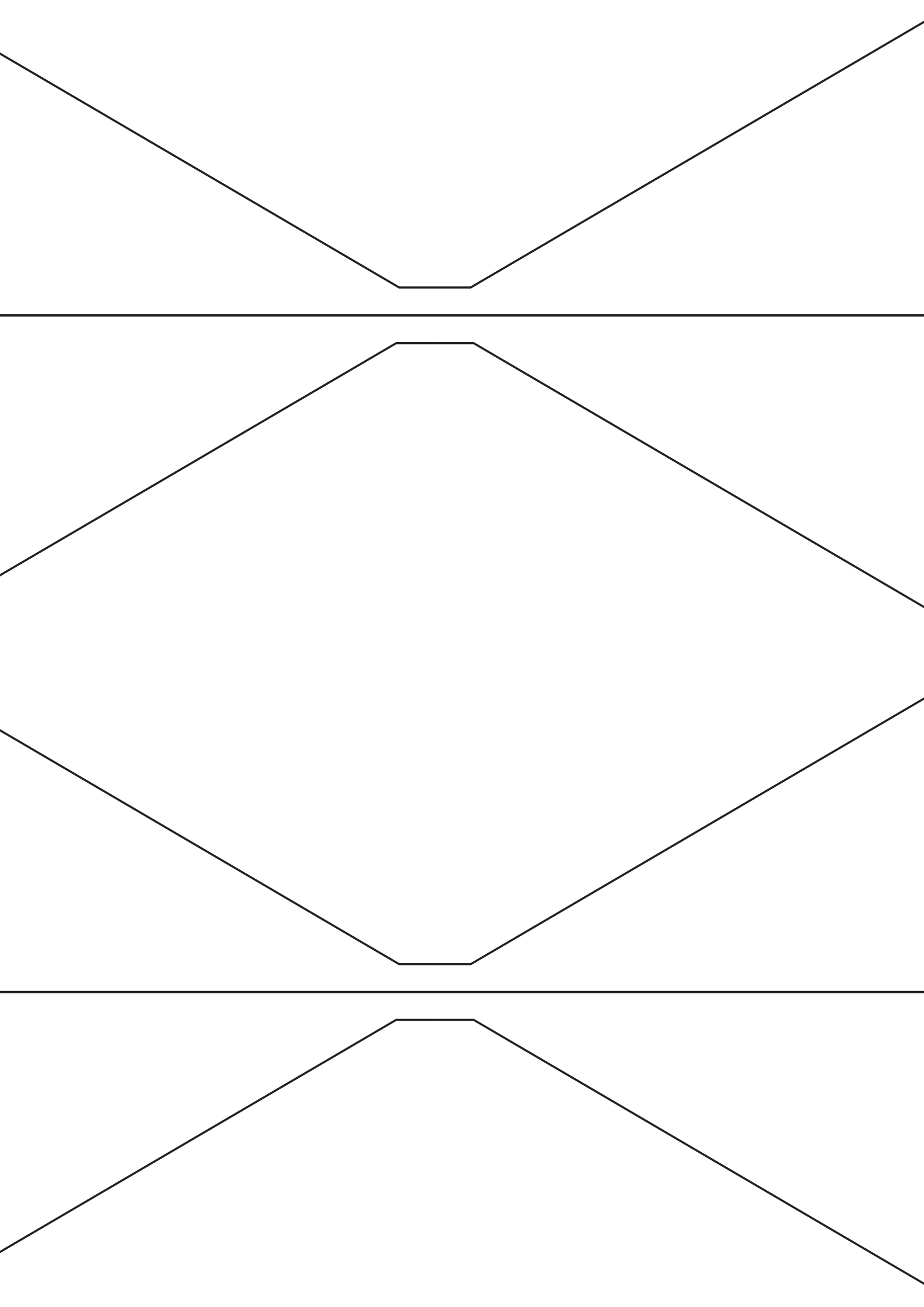



“by using well known construction techniques, we wanted to create a design with an absolute generic appearance, which would allow the structure and the materials to perform as the ultimate leading character”























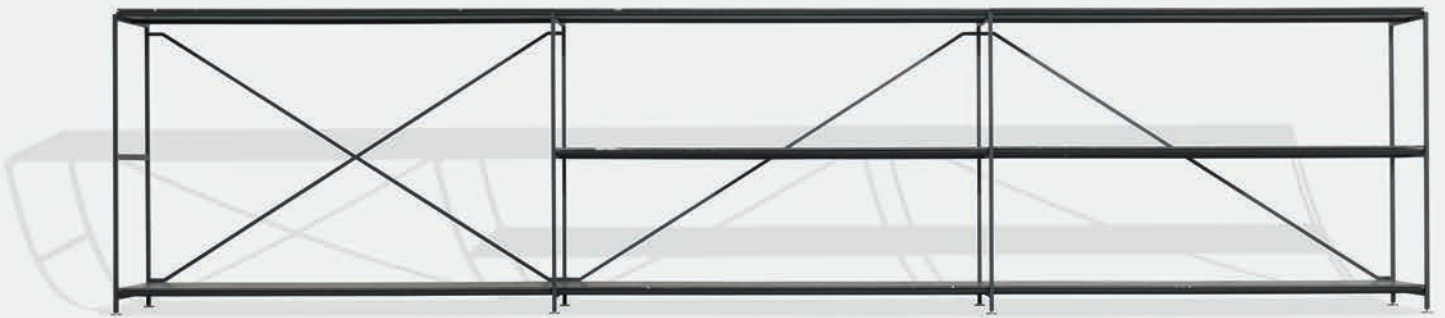

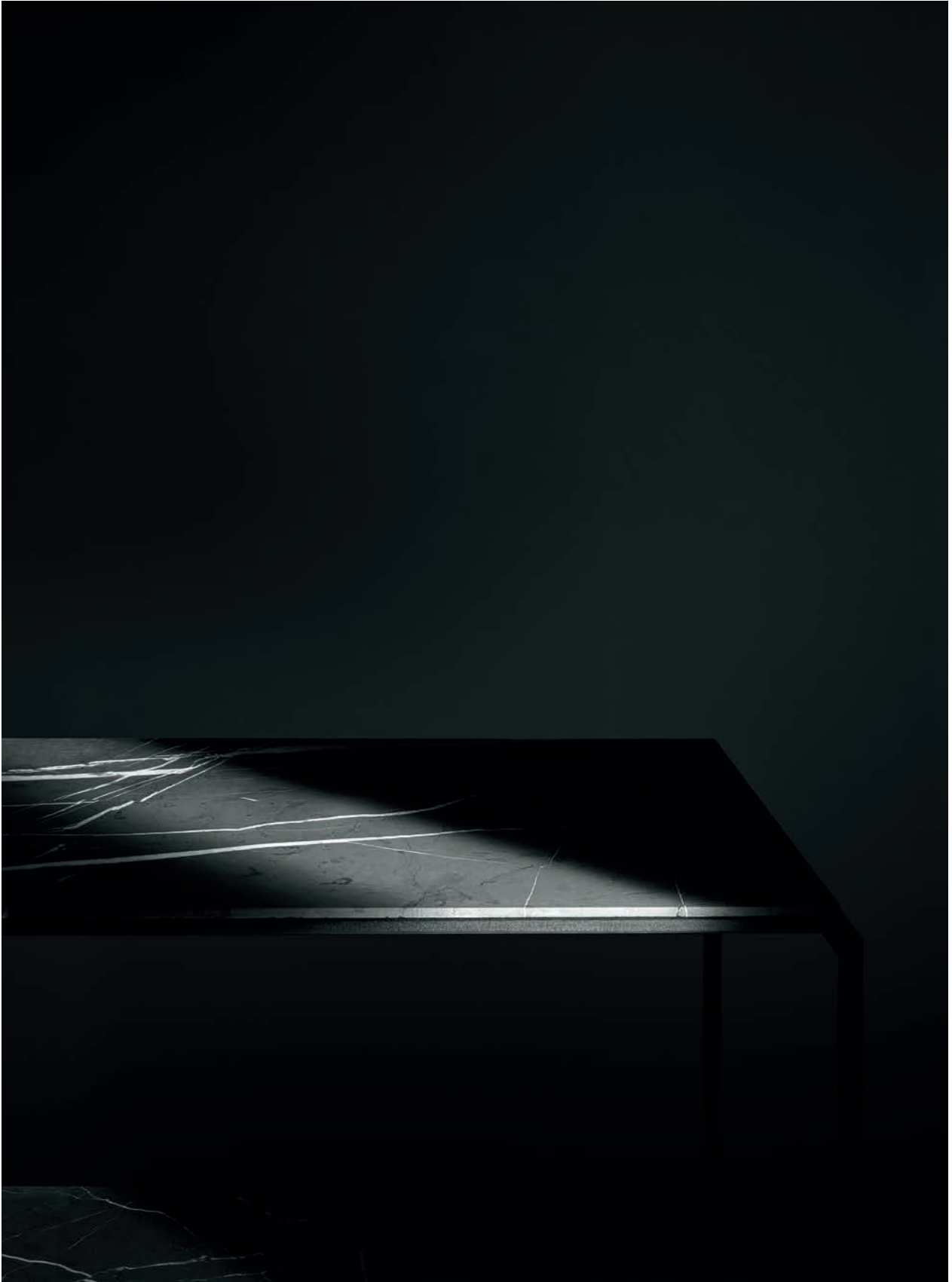

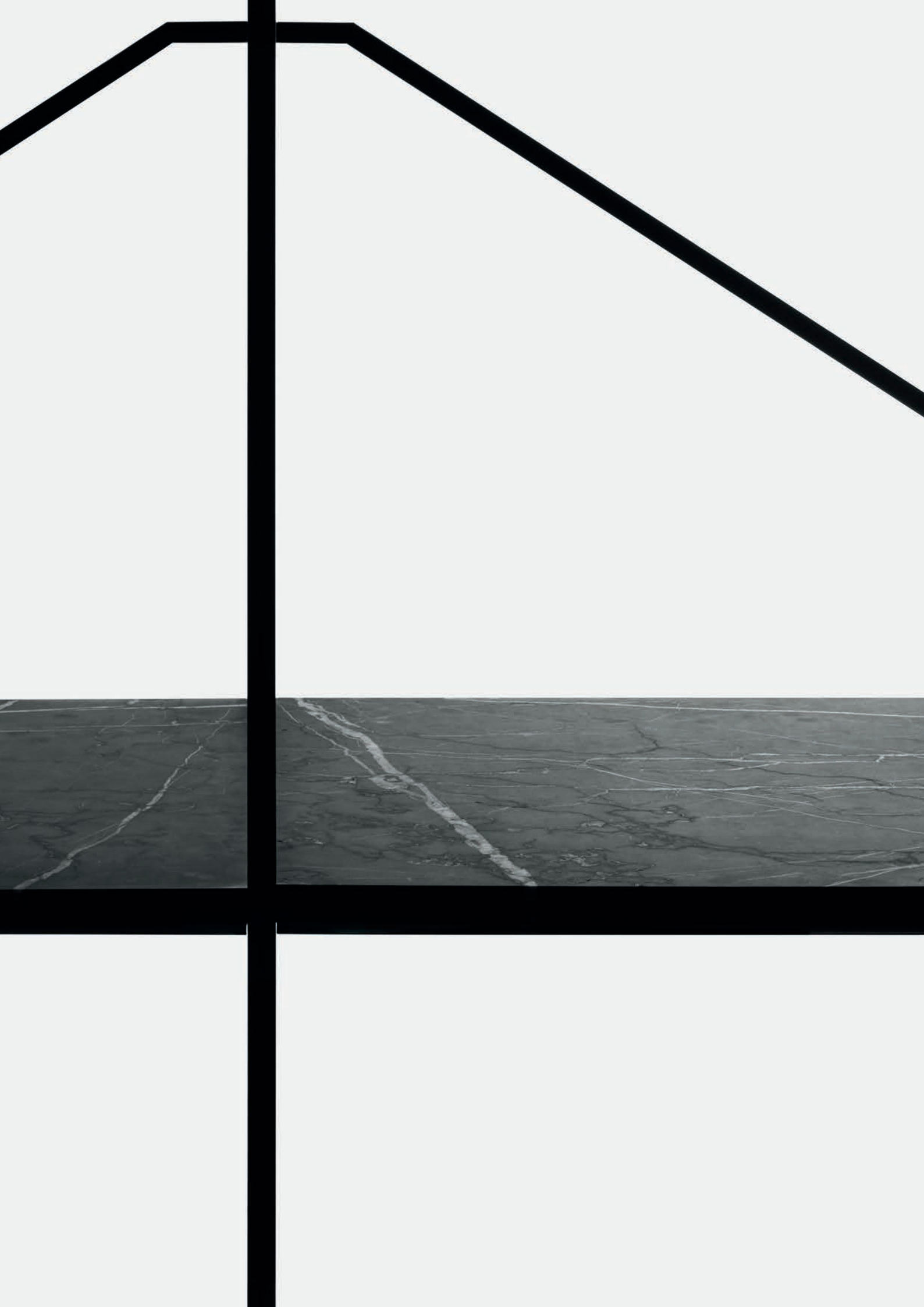





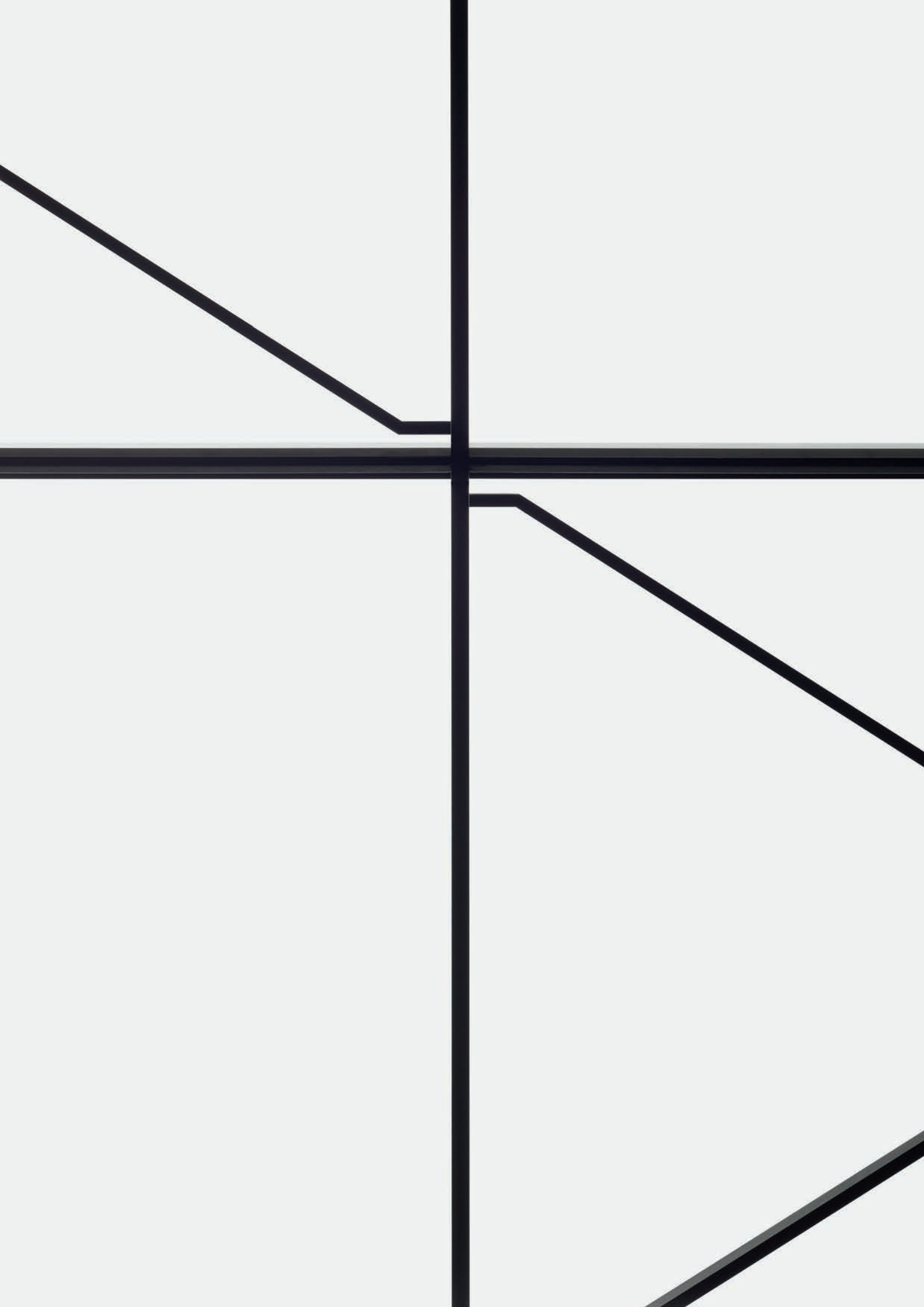

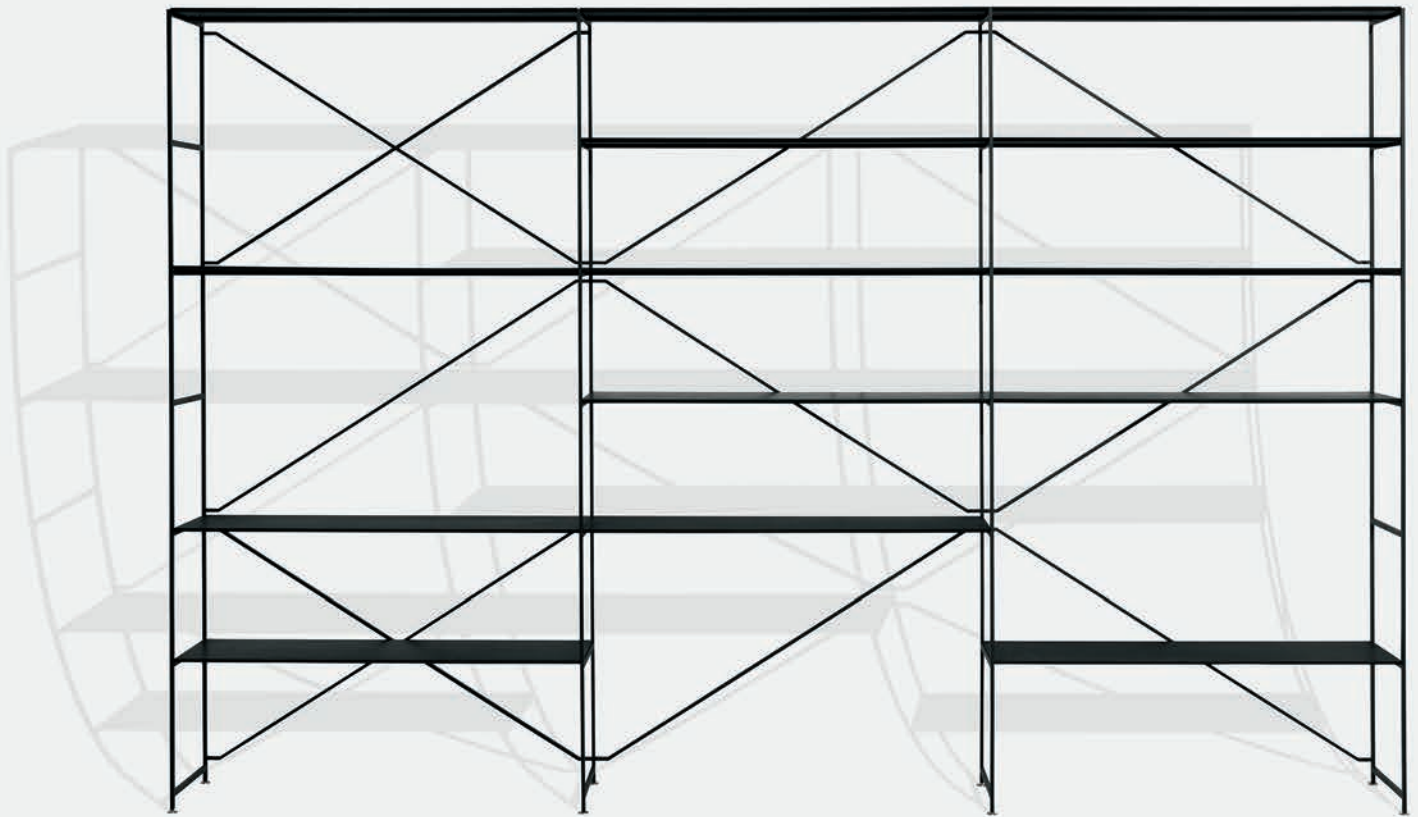







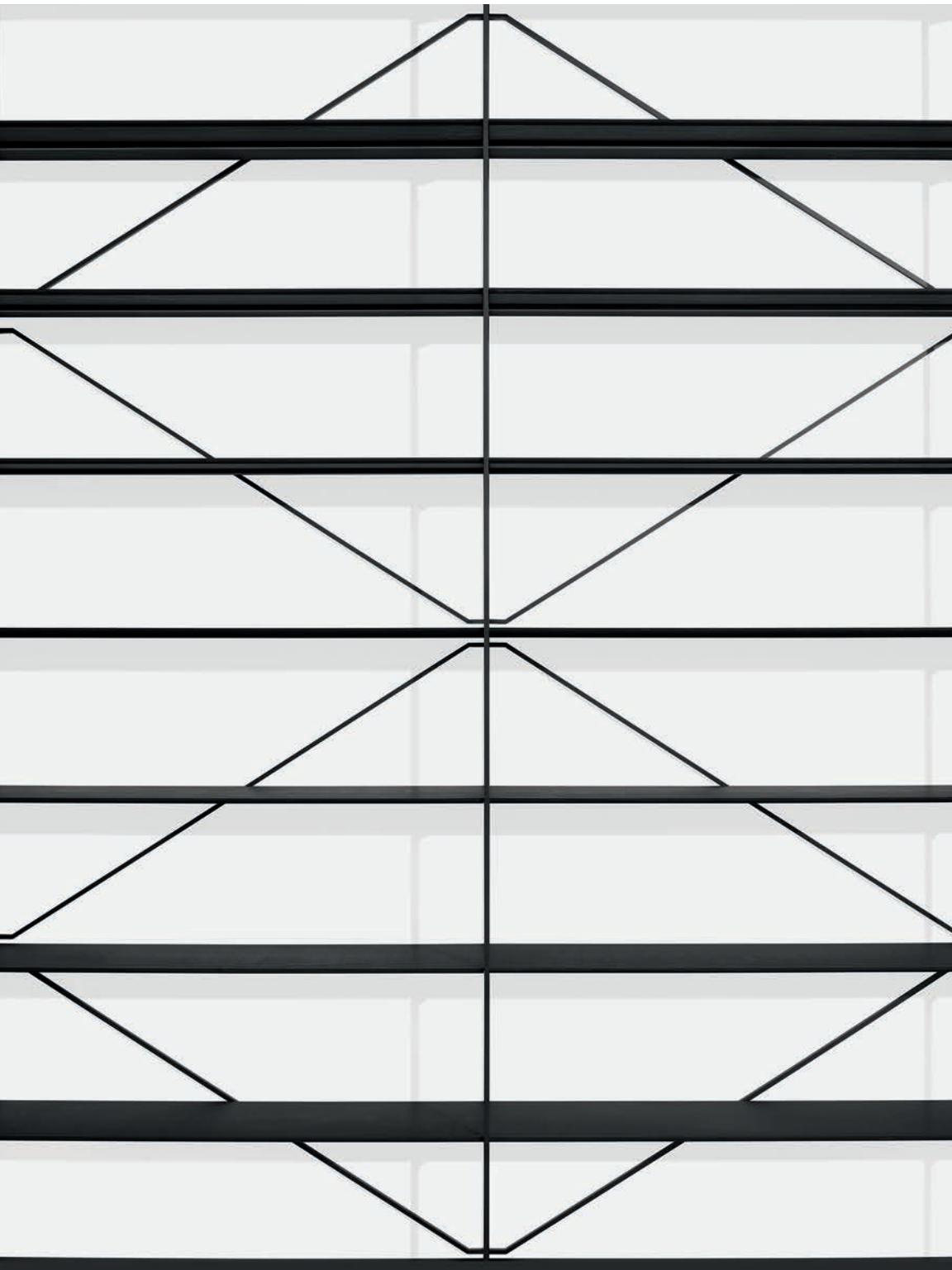







**R.I.G.
BENCH**

**RUDIMENTARY
INTERIOR
GEOMETRY**

DESIGN BY MIKAL HARRSEN & ADAM HALL





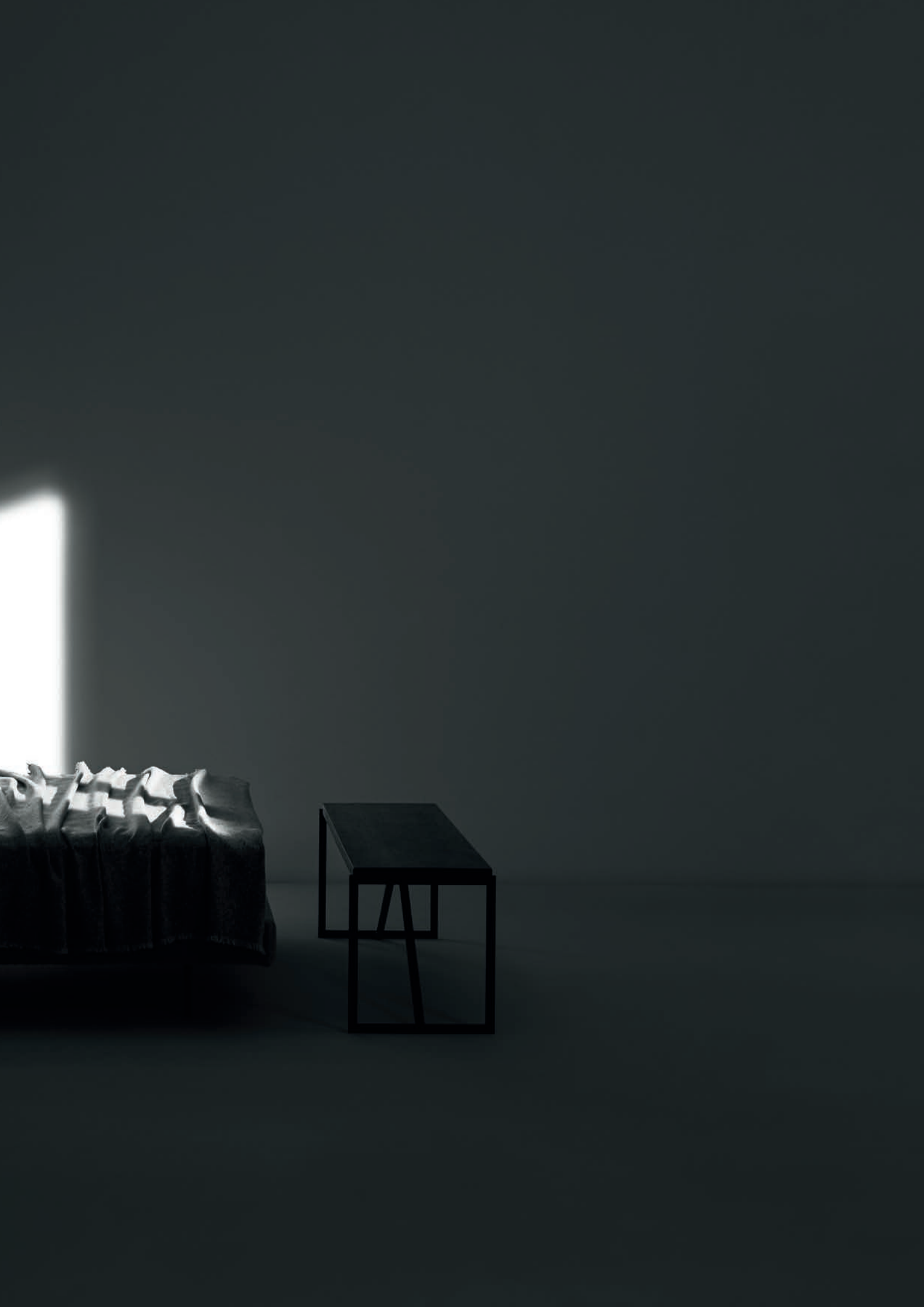





The background features several black lines that create a series of overlapping, angular shapes, resembling a stylized mountain range or a series of peaks and valleys. The lines are thin and black, set against a plain white background.

**T.T.A.
TABLE**

**TRIBUTE
TO
ALBERS**

DESIGN BY MIKAL HARRSEN

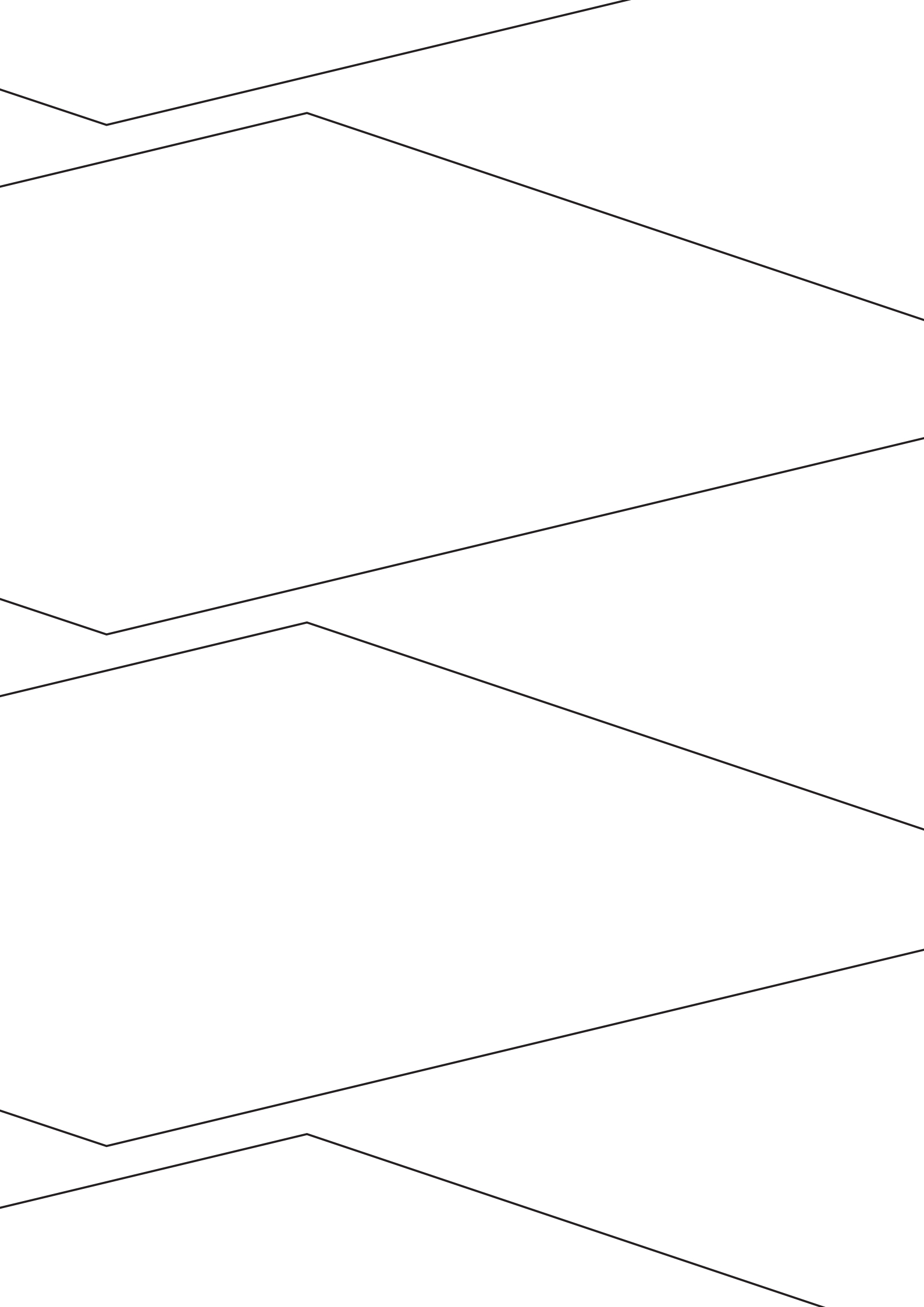



“inspired by the optical experimental works of Josef Albers, we set out to create a simple geometrical structure for a table frame”





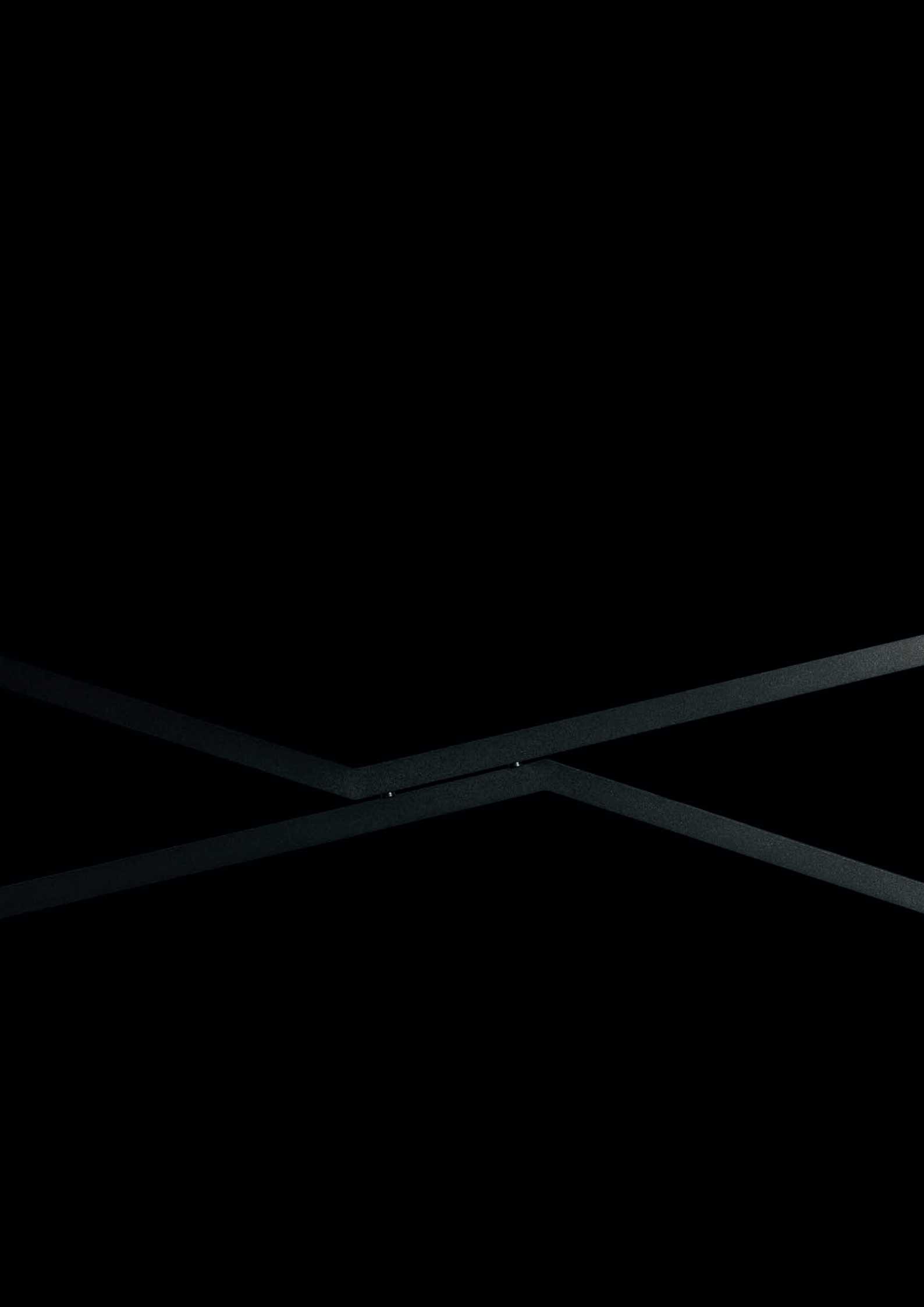

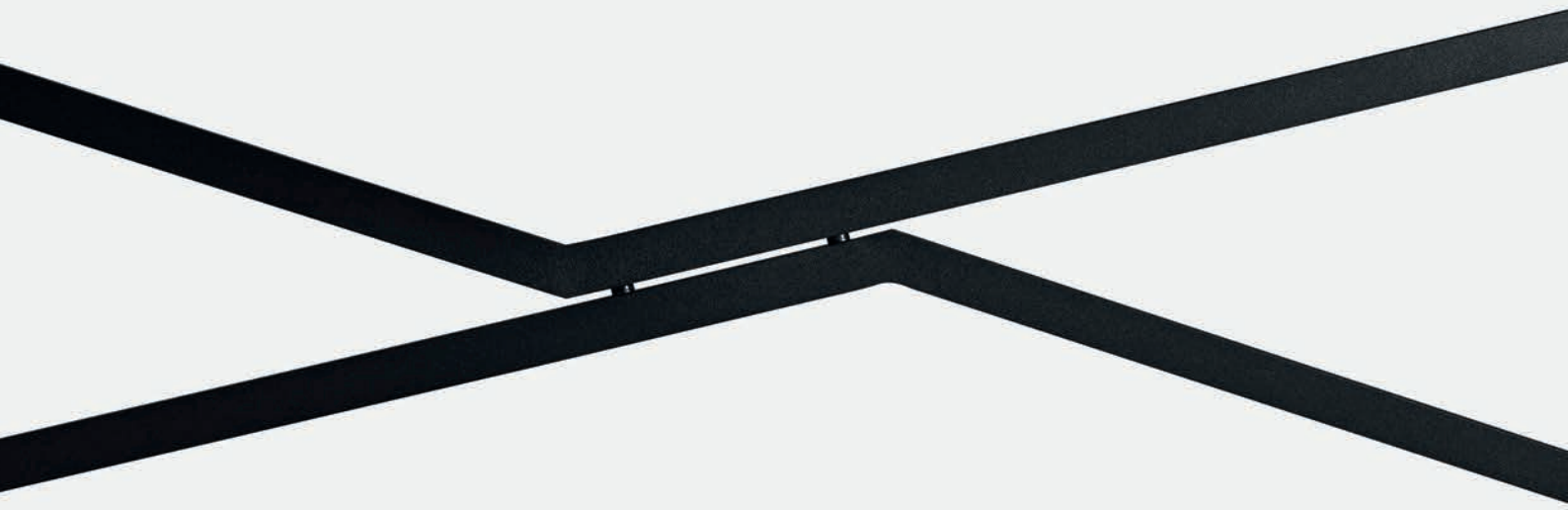



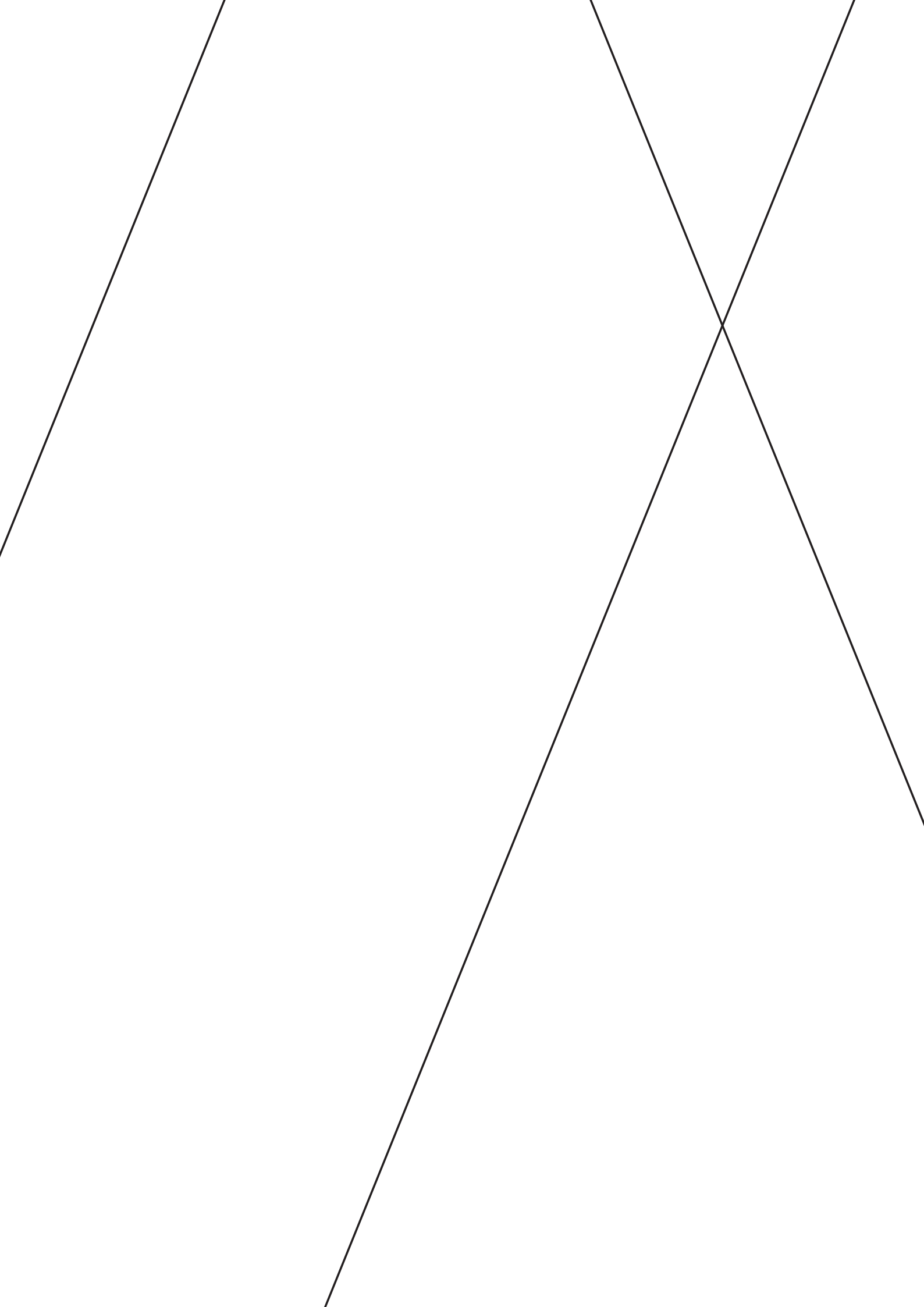



**N.E.T.
TABLE**

**NEVER
ENDING
TABLE**

DESIGN BY SØREN ULRIK PETERSEN



“the name derives from our ability to produce tables in important length. Not to mention the never ending dinners, stories, meetings and social gatherings that will create the patina of these pieces”







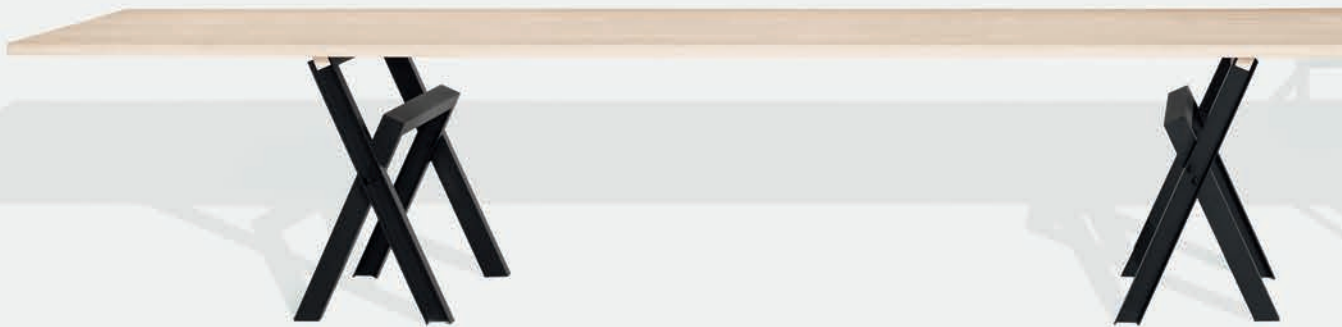
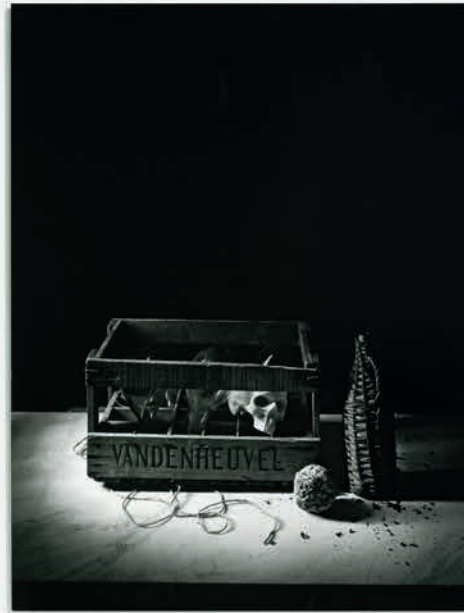

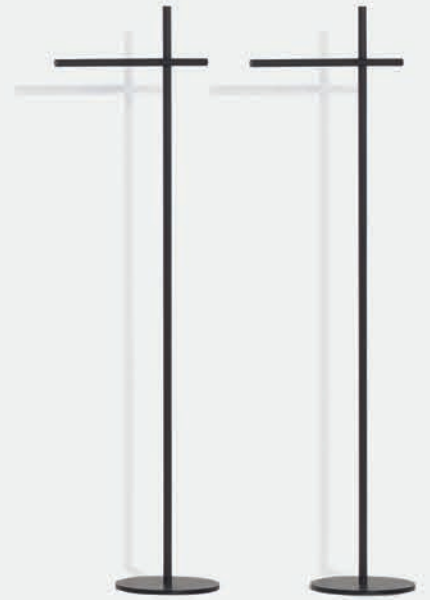

**C.O.P.
STORAGE SYSTEM**

**CREATIVE
OFFICE
PROJECT**

DESIGN BY MIKAL HARRSEN

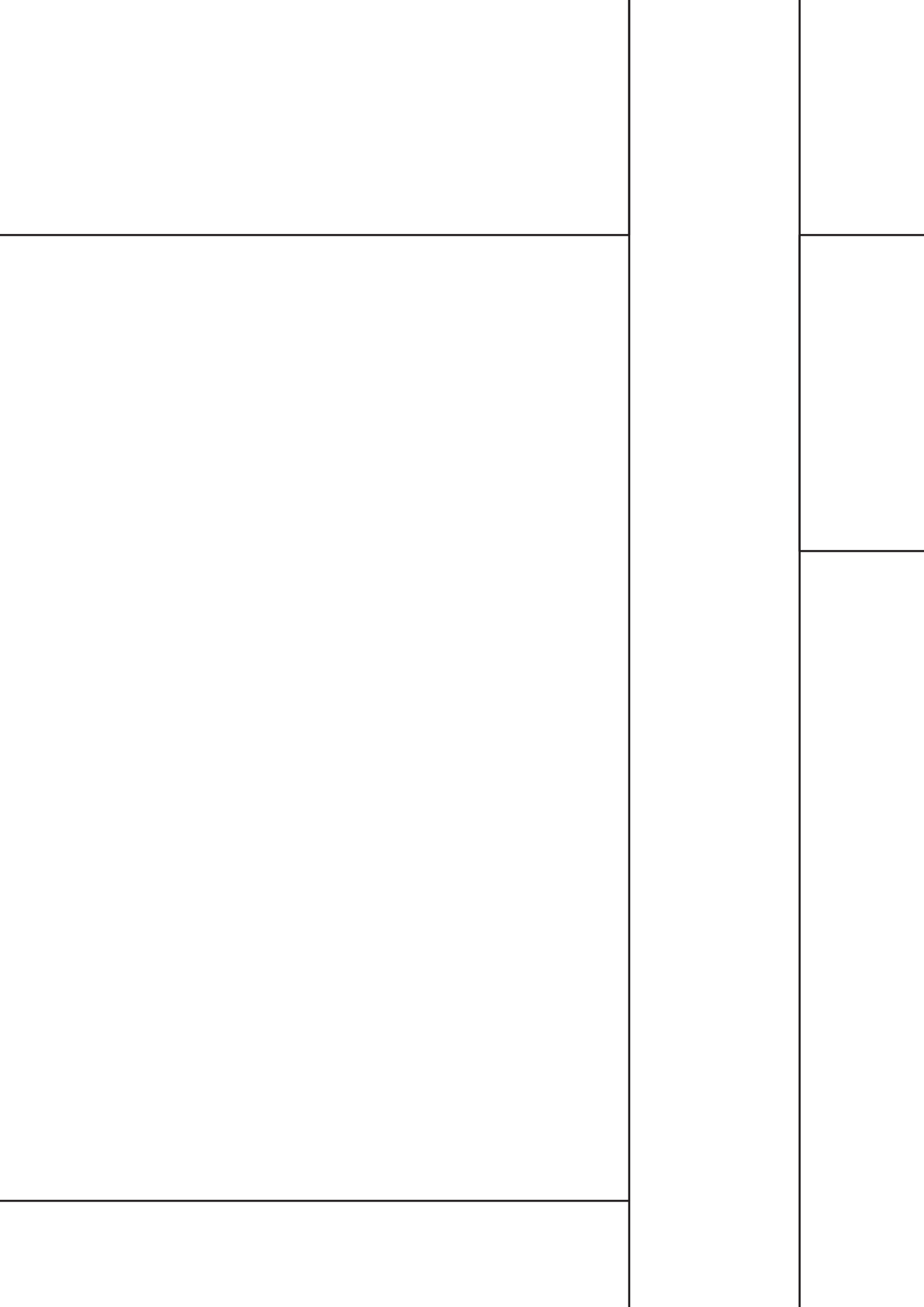



“with the ‘Creative Office Project’ MA/U Studio has set out to provide new standards for furnishing offices and creative workspaces. The C.O.P. system offers an unmatched flexible storage solution with its concealed rail mounting system”









C.O.P. STORAGE SYSTEM



INDEX DE PADOVA COLLECTION

DONZELLETTA M. DE LUCCHI, 2017 / CHAIR	PAG. 58 59
INCISA V. MAGISTRETTI CENTRO DESIGN BINFARÉ, 1992 / CHAIR	PAG. 12 13
LC03 M. VAN SEVEREN F. SCHWAERZLER, 2003 / ARMCHAIR	PAG. 30 31
LLO4 M. VAN SEVEREN, 2004 / ARMCHAIR	PAG. 8 9
MARGHERITA P. LISSONI, 2017 / ARMCHAIR	PAG. 24 25, 68 69
MOSAÏQUE P. LISSONI, 2017 / POUF	PAG. 18 19
NOTA E. OSSINO, 2017 / LAMP	PAG. 18 19, 30 31, 58 59, 68 69
SAIL NENDO, 2017 / SMALL TABLE	PAG. 24 25
SEN K. OSHIRO, 2016 / SMALL TABLE	PAG. 24 25, 40 41
SILVER V. MAGISTRETTI, 1989 / CHAIR	PAG. 12 13, 15
SLEEPING CAR V. MAGISTRETTI, 2004 / BED	PAG. 40 41, 70
SO N. FUKASAWA, 2017 / CHAIR	PAG. 48 49, 62 63
SQUARE TRADITIONAL, 2017 / SOFA	PAG. 24 25
TWIG K. TAKEUCHI, 2017 / LAMPS	PAG. 8 9, 62 63

NOVELTIES '18

R.I.G. MODULES 402

DESIGN BY MIKAL HARRSEN

INSERT COMPOSITIONS

Pag. IV V
4 modules
L 110

Dimension:
445 x 50 x 41,8 cm
Materials:
Structure - matte black
Cabinets - CDF black
+ greystone marble
Top - greystone marble
Shelves - greystone marble

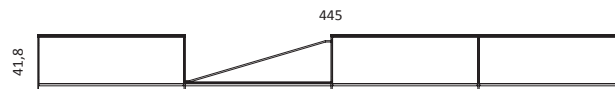

Pag. IV V
5 modules
L 110

Dimension:
556 x 50 x 41,2 cm
Materials:
Structure - matte black
Cabinets - CDF black
+ greystone marble
Top - glass
Shelves - greystone marble

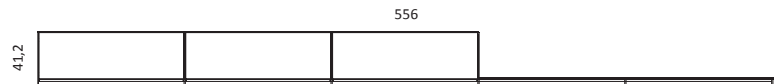

R.I.G. MODULES

DESIGN BY MIKAL HARRSEN

Pag. VIII
2 modules
L 110

Dimension:
223 x 38,4 x 146,4 cm
Materials:
Structure - matte black
Cabinets - CDF black + Alpi 18.04
Shelves and desk - CDF black
+ Alpi 18.04

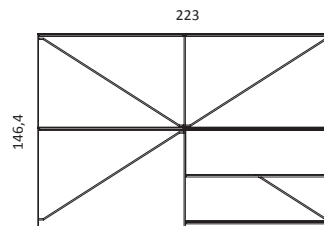

Pag. X XI
4 modules
L 110

Dimension:
445 x 38,4 x 217,2 cm
Materials:
Structure - matte black
Cabinets - CDF black
+ smoked oak
Shelves - CDF black
+ smoked oak

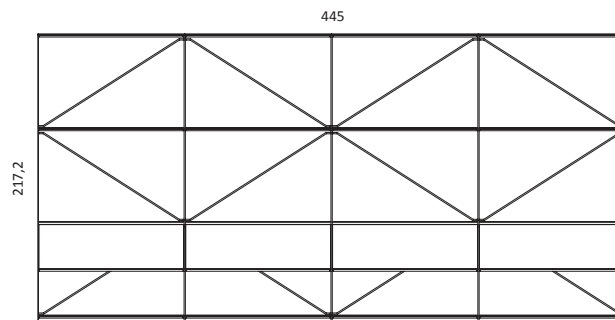

R.I.G. MODULES KITCHEN

DESIGN BY MIKAL HARRSEN

Pag. XIV XV
4 modules
L 110

Dimension:
556 x 38,4 x 217,2 cm
Materials:
Structure - matte black
Cabinets - CDF black + Alpi 18.22
Top - glass
Shelves - CDF black + Alpi 18.22
Accessories - CDF black + Alpi 18.22

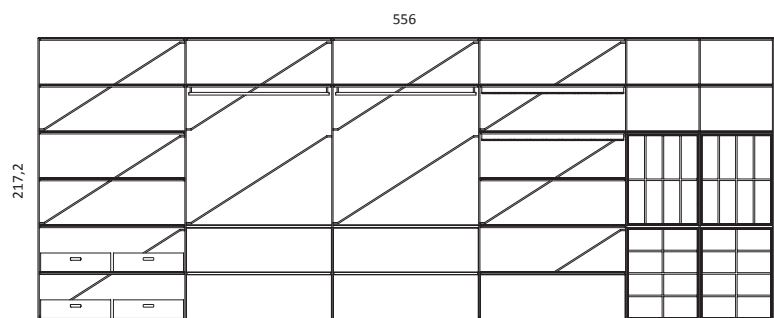

NOVELTIES '18

R.I.G. MODULES BATHROOM

DESIGN BY MIKAL HARRSEN

INSERT COMPOSITIONS

Pag. XXII
2 modules
L 110

Dimension:
223 x 50 x 90,6 cm
Materials:
Structure - matte black
Cabinet - gris du Marais marble
Shelves - gris du Marais marble
Washbasin - gris du Marais marble
+ Garden PVD faucet
Boffi collection

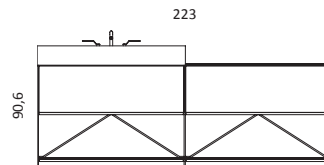

Pag. XVIII XIX
2 modules
L 110

Dimension:
278,5 x 60 x 90,6 cm
Materials:
Structure - matte black
Cabinet - white Carrara marble
Shelves - white Carrara marble
Washbasin - white Carrara marble
+ Eclipse PVD faucet
Boffi collection

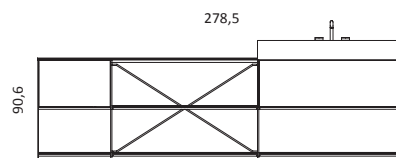

1 module
L 55

R.I.G. MIRROR

DESIGN BY MIKAL HARRSEN

Pag. XX XXI

R.I.G. Freestanding Mirror
Dimension:
98,2 x 98,2 x 217,2 cm
Materials:
Structure - matte black + mirror

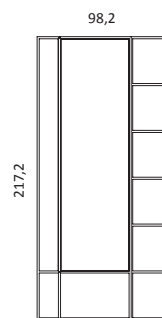

R.I.G. Wall Mirror
Dimension:
111 x 4 x 217,2 cm
Materials:
Structure - matte black + mirror
with LED lightbar

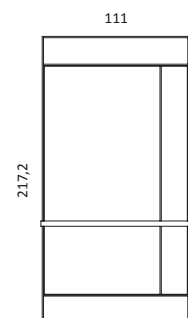

R.I.G. MODULES WARDROBE

DESIGN BY MIKAL HARRSEN

Pag. XXVI
XXVII
2 modules
L 110
2 modules
L 55

Dimension:
334 x 60 x 288 cm
Materials:
Structure - matte black
Shelves - CDF black + Alpi 18.22
Cabinets - CDF black + Alpi 18.22

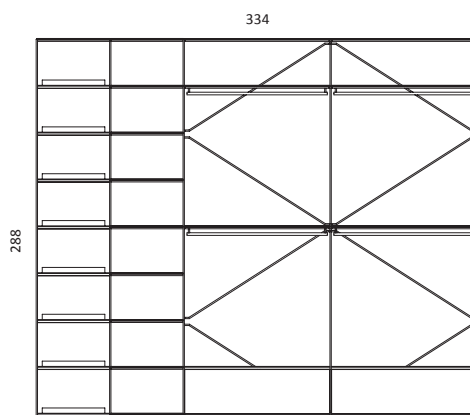

Pag. XXVIII
XXIX
4 modules
L 110

Dimension:
445 x 60 x 288 cm
Materials:
Structure - matte black
Shelves - CDF black + Alpi 18.22
Cabinets - CDF black + Alpi 18.22

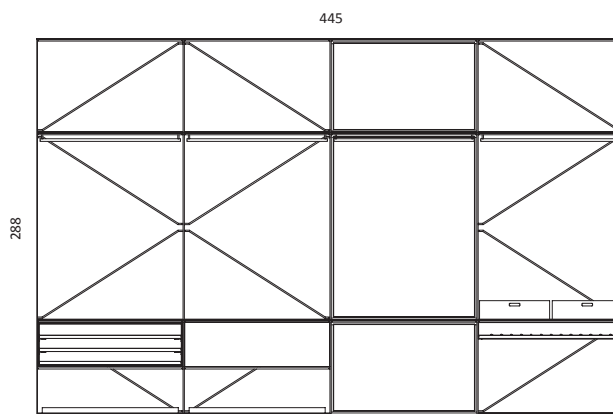

R.I.G. MODULES

DESIGN BY MIKAL HARRSEN

CATALOGUE COMPOSITIONS

Pag. 16
1 module
L 110

Dimension:
112 x 38,4 x 217,2 cm
Materials:
Structure - matte black
Shelves - white Carrara marble

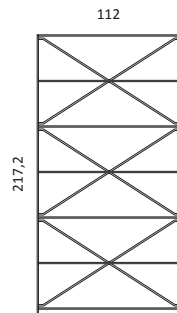

Pag. 20
3 modules
L 110

Dimension:
334 x 38,4 x 75,6 cm
Materials:
Structure - matte black
Shelves - greystone marble

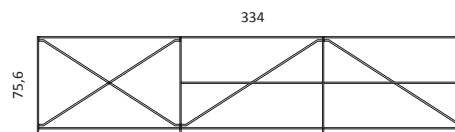

Pag. 28
3 modules
L 110

Dimension:
334 x 38,4 x 217,2 cm
Materials:
Structure - matte black
Shelves - CDF black

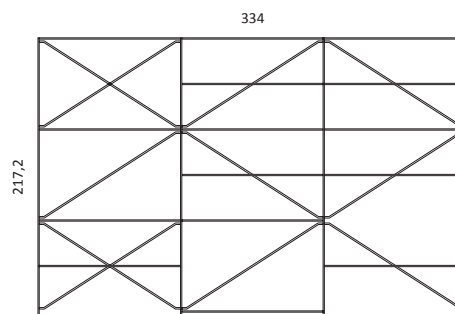

Pag. 8 9
4 modules
L 110

Dimension:
445 x 38,4 x 217,2 cm
Materials:
Structure - matte black
Shelves - CDF black

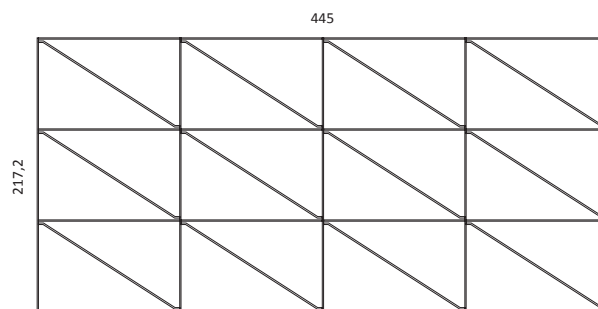

Pag. 18 19
5 modules
L 110

Dimension:
556 x 38,4 x 75,6 cm
Materials:
Structure - matte black
Shelves - greystone marble

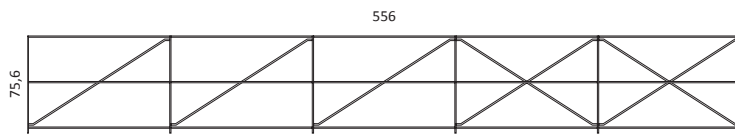

Pag. 24 25
5 modules
L 110

Dimension:
556 x 38,4 x 217,2 cm
Materials:
Structure - matte black
Shelves - white Carrara marble

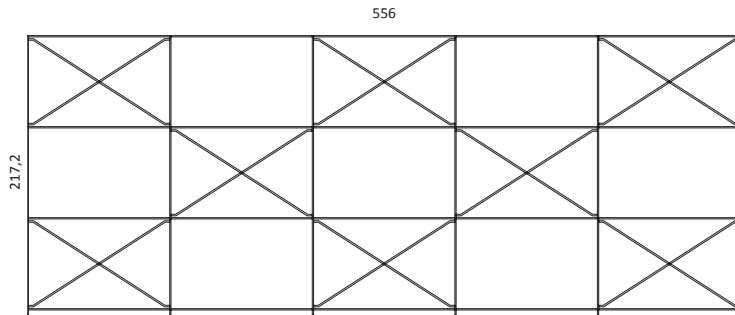

Pag. 30 31
5 modules
L 110

Dimension:
556 x 38,4 x 288 cm
Materials:
Structure - matte black
Shelves - CDF black

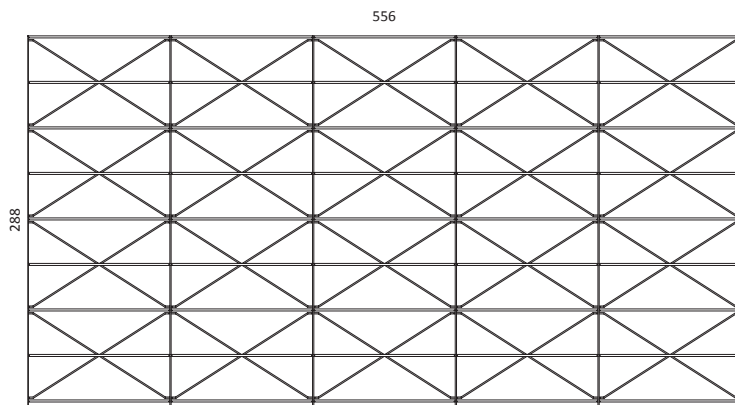

Pag. 12 13
6 modules
L 110

Dimension:
667 x 38,4 x 217,2 cm
Materials:
Structure - white
Shelves - white MDF

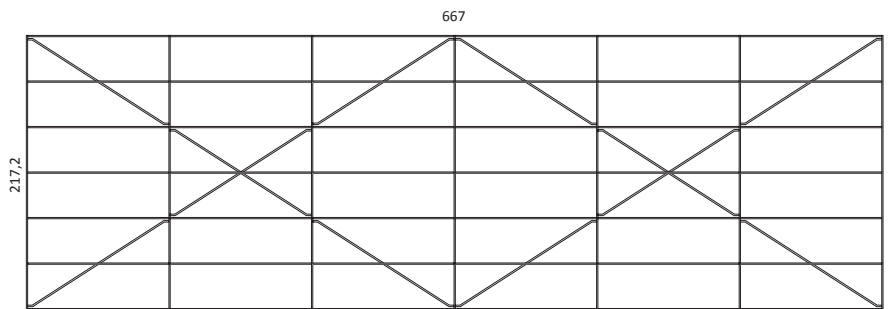

R.I.G. MODULES OTHER COMPOSITIONS

1 module
L 110
Dimension:
112 x 38,4 x 75,6 cm
Materials:
Structure - white
Shelves - white MDF

1 module
L 110
Dimension:
112 x 38,4 x 75,6 cm
Materials:
Structure - white
Shelves - white MDF

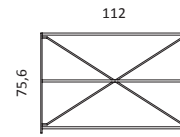
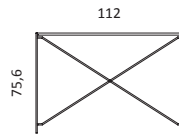

1 module
L 110
Dimension:
112 x 38,4 x 75,6 cm
Materials:
Structure - matte black
Shelves - CDF black

1 module
L 110
Dimension:
112 x 38,4 x 75,6 cm
Materials:
Structure - matte black
Shelves - glass

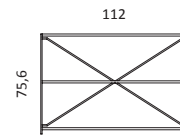
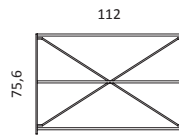



R.I.G. MODULES OTHER COMPOSITIONS

2 modules
L 110

Dimension:
223 x 38,4 x 75,6 cm
Materials:
Structure - white
Shelves - white MDF

2 modules
L 110

Dimension:
223 x 38,4 x 75,6 cm
Materials:
Structure - white
Shelves - white MDF

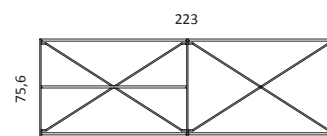
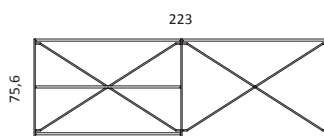

2 modules
L 110

Dimension:
223 x 38,4 x 75,6 cm
Materials:
Structure - white
Shelves - CDF natural oak

2 modules
L 110

Dimension:
223 x 38,4 x 75,6 cm
Materials:
Structure - matte black
Shelves - CDF natural oak

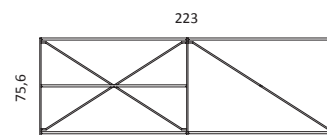
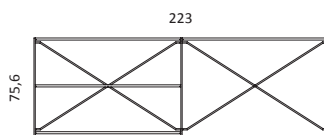



R.I.G. MODULES OTHER COMPOSITIONS

1 module
L 110
Dimension:
112 x 38,4 x 217,2 cm
Materials:
Structure - white
Shelves - white MDF

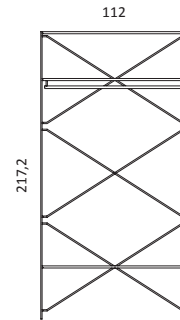
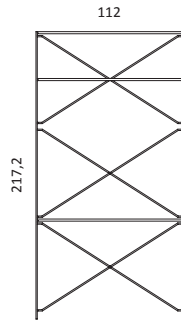

1 module
L 110
Dimension:
112 x 38,4 x 217,2 cm
Materials:
Structure - white
Shelves - white MDF

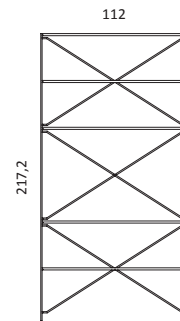
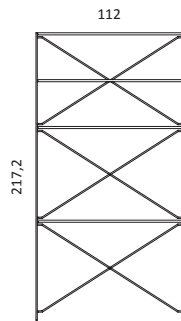

1 module
L 110
Dimension:
112 x 38,4 x 217,2 cm
Materials:
Structure - white
Shelves - CDF natural oak

1 module
L 110
Dimension:
112 x 38,4 x 217,2 cm
Materials:
Structure - white
Shelves - white MDF

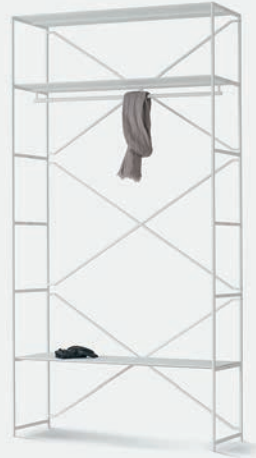

R.I.G. MODULES OTHER COMPOSITIONS

1 module
L 110

Dimension:
112 x 38,4 x 217,2 cm
Materials:
Structure - matte black
Shelves - CDF black

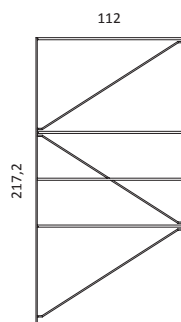

2 modules
L 110

Dimension:
223 x 38,4 x 217,2 cm
Materials:
Structure - matte black
Shelves - CDF black

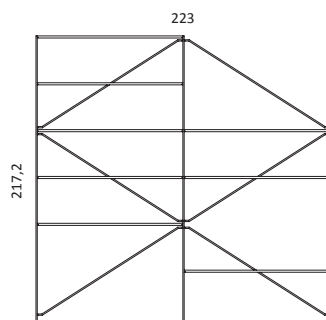

3 modules
L 110

Dimension:
334 x 38,4 x 217,2 cm
Materials:
Structure - matte black
Shelves - CDF black + glass

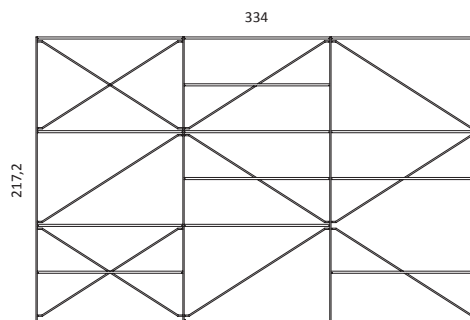

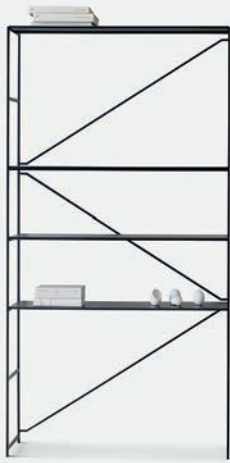

R.I.G. MODULES OTHER COMPOSITIONS

2 modules
L 110

Dimension:
223 x 38,4 x 217,2 cm
Materials:
Structure - white
Shelves - white MDF

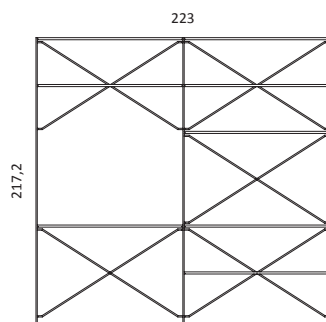

2 modules
L 110

Dimension:
223 x 38,4 x 217,2 cm
Materials:
Structure - white
Shelves - white MDF

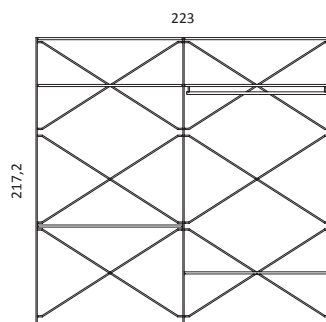



R.I.G. BENCH

DESIGN BY MIKAL HARRSEN & ADAM HALL

Image
on the right

Dimension:
200 x 38 x 45,8 cm
Materials:
Frame - matte black
Top - smoked oak

Pag. 38
L 200

All dimensions:
160 x 38 x 45,8 cm
200 x 38 x 45,8 cm

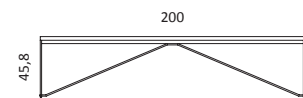
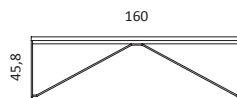

R.I.G. TABLE

DESIGN BY MIKAL HARRSEN

Image
on the right

Dimension:
200 x 80 x 71,5 cm
Materials:
Frame - matte black
Top - CDF black

All dimensions:
140 x 80 x 71,5 cm
160 x 80 x 71,5 cm
180 x 80 x 71,5 cm
200 x 80 x 71,5 cm

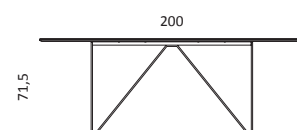
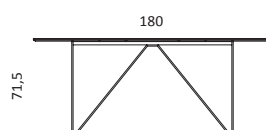
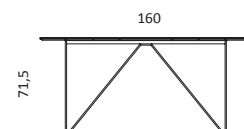
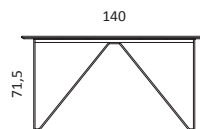



T.T.A. TABLE

DESIGN BY MIKAL HARRSEN

Pag. 48 49
L 340

Pag. 52
L 240

Dimension:

180 x 90 x 72 cm

240 x 90 x 72 cm

280 x 90 x 72 cm

340 x 90 x 72 cm

Materials:

Frame - matte black

Top - CDF black

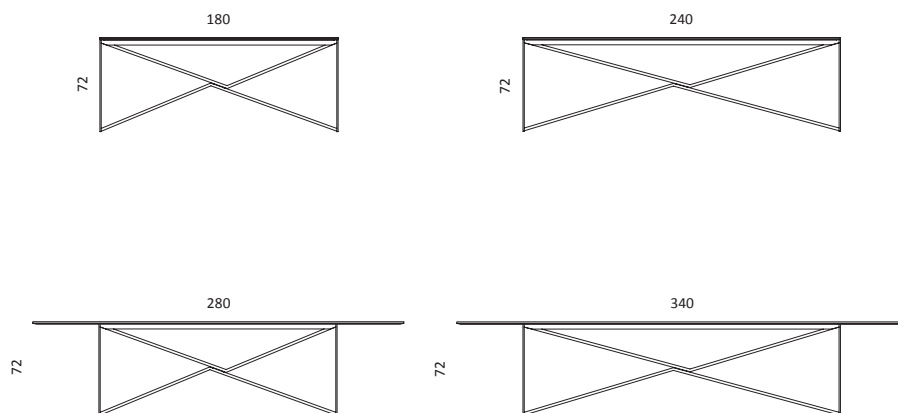

N.E.T. TABLE

DESIGN BY SØREN ULRIK PETERSEN

Pag. 58 59
400 cm

Pag. 62 63
600 cm

Dimension:

400 x 90 x 74 cm

600 x 90 x 74 cm

Materials:

Trestle - matte black

Top - bleached douglas wood

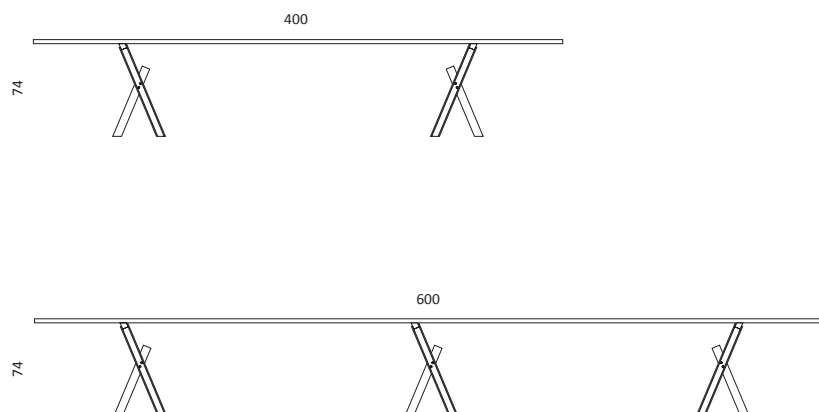

C.O.P. STORAGE SYSTEM

DESIGN BY MIKAL HARRSEN

Pag. 68 69

Dimension:

26 x 32 x 66,6 cm

Materials:

black coated steel sheet

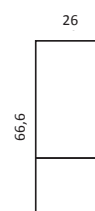
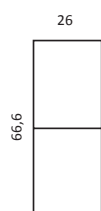

CREDITS

Graphic project / Graph.X
Photo / Tommaso Sartori
Styling / Elisa Ossino Studio
Rendering / Virtual Design
Retouching, Pre Press / A. DePedrini
Printed in Italy
by Nava Press 2018

THANKS TO

Altai
Arte nel pozzo
Bitossi
Bloc Studios
C&C
Casa Filosofia
Flos
Guido De Zan
Mani
Romina Gris
Young Ran Lee

SPECIAL AGREEMENT

Salvatori

MA/U STUDIO

via Santa Cecilia, 7
20122 Milano, Italy
T. +39 02 27439769
contact@maustudio.net
www.maustudio.net

