

1

Kalypso, Kora, Amber, Bubbles,
Cashmere, Diamond, Dry, Gong, Loto,
Nabhi Collection, Nami, Roma, Scarlet,
Tao, Hashi Easel, Kato Easel, Stick,
Wall Bracket, Tray, Wood Top,
Wood Box.

Bathroom Collection

Vasca / Bathtub	
Kalypso	2
Kora	4

Lavabo / Washbasin	
Amber	8
Bubbles	12
Cashmere	20
Diamond	24
Dry	28
Gong	34
Loto n°1 & n°2	44

Nabhi Collection:	
Bowl n°1	50
Bowl n°2	56
Bowl n°3	58
Bowl n°4	62
Bowl n°6	64
Bowl n°8	66
Bowl n°9	68
Bowl n°10	70

Nami	72
Roma	76
Scarlet	80
Tao	84

Cavalletto / Easel	
Hashi Easel	90
Kato Easel	92
Stick	96
Wall Bracket	98

Top	
Tray	
Wood Top	

Contenitore / Cabinet	
Wood Box	100

Data sheet	105
-------------------	------------

1. Bathroom Collection

Company

Straordinaria creatività e sperimentazione nel campo della lavorazione del marmo, Kreoo realizza arredi e complementi ad alto tasso di design per l'architettura, l'interior e l'outdoor. Il brand nasce nel 2010 sulla base della ultra cinquantennale esperienza di Decormarmi, per interpretare attraverso le sue collezioni una inesplorata dimensione dell'oggetto in marmo ed esaltarne la sua anima segreta e sensuale: in Kreoo il materiale lapideo può essere accostato ad altri elementi materici come il legno, il vetro e i metalli, creando nuove forme e spessori e donando nuove funzionalità agli oggetti del nostro vivere quotidiano. Il nome Kreoo ha un preciso riferimento al verbo greco kraino che significa "creare, realizzare": dalla Grecia classica Kreoo trae l'istinto alla perfezione e all'armonia delle forme che traduce, in Italia, in un vocabolario estetico contemporaneo e fortemente innovativo. I valori fondanti del brand sono da considerarsi nella qualità del processo produttivo, che ricerca i migliori materiali e li lavora calibrando sapientemente processi industriali alla manifattura artigiana, e nella cultura del progetto e creatività italiana, la cui trasversalità e l'interdisciplinarietà permettono la creazione di opere uniche. Particolare attenzione viene anche riservata agli aspetti di sostenibilità ambientale, riducendo il più possibile il materiale di scarto nelle lavorazioni e riutilizzandolo, ove possibile, all'interno della filiera produttiva. Il design di molti prodotti è stato affidato all'estro del designer veneto Enzo Berti, e negli anni si sono aggiunte collaborazioni con Marco Piva, Sebastiano Zilio, Paolo Ulian e Moreno Ratti. Il rapporto instaurato con i designers massimizza le capacità espressive del materiale, creando elementi in grado di possedere un'anima: oggetti forti, in qualche misura tradizionali, ma che inducono, quasi inavvertitamente, ad un progresso nel saper vedere le cose. L'azienda propone una già vasta collezione, sistemi flessibili declinati in pezzi di grande seduzione che, in alcuni casi, sono diventati icone del marchio, come il lavabo Gong, la vasca Kora, le sedute Pavè Stone o il tavolo Arcaico. Precisa, innovativa e attenta anche la scelta dei materiali: una sorta di cartella colori che predilige nuance di bianchi, grigi e neri, ma si accende anche dei bagliori dei verdi, blu, rossi, svelando sfumature e venature uniche del materiale. Kreoo è oggi distribuito a livello internazionale, con ottima copertura del territorio europeo, americano, russo e arabo, con la collocazione dei suoi prodotti nelle migliori showroom, da San Francisco a Dubai, da Mosca a Hong Kong, e fino all'Australia.

Extraordinary creativity and experimentation in the field of marble processing, Kreoo realizes furniture and accessories with high design level for architecture, interiors and outdoors. The brand was born in 2010, on the basis of the 50-year-long experience by Decormarmi, to interpret through its collections an unexplored dimension of the marble item and exalting its sensual and secret soul: in Kreoo marble can be combined with other materials such as wood, glass or metal, creating new shapes and thicknesses and giving new functionalities to the objects of our daily lives. The name Kreoo has a precise reference to the Greek verb kraino meaning "to create, to realize": from Ancient Greece, Kreoo draws the instinct for perfection and harmony and translate it, in Italy, into a contemporary, aesthetic and innovative vocabulary. The founding values of the brand are in the quality of the production process, whose research the best materials and work them by wisely calibrating industrial processes with an artisan craftsmanship, and in the Italian Design history and creativity, whose wide spread approach and interdisciplinary perspective allow the creation of unique works. Particular attention is also paid to aspects of environmental sustainability, reducing as much as possible the waste of material during the production and reusing it, where possible, within the production chain. The design of many products has been appointed to the inspiration of the Venetian designer Enzo Berti, and over the years new collaborations with Marco Piva, Sebastiano Zilio, Paolo Ulian and Moreno Ratti have been added. The relationship established with the designers maximizes the expressive capabilities of the material, creating objects that possess a soul: strong objects, in some way "traditional", that induce, almost inadvertently, to an improvement in the ability to seeing things. The company already offers a wide collection, flexible systems declined in high seduction pieces that, in some cases, have become icons of the brand, such as Gong washbasin, Kora bathtub, Pavè Stone seats or Arcaico table. Precise, innovative and careful is the choice of materials: a sort of colour palette that prefers nuance of whites, grays and blacks, but also lights up with flashes of green, blue and red, revealing unique and refined shades of the marble material. Kreoo is today internationally distributed, with a very good coverage in European, American, Russian and Arabic territories, with its products displayed in the best showrooms, from San Francisco to Dubai, from Moscow to Hong Kong, 'till the far Australia.

Kalypso

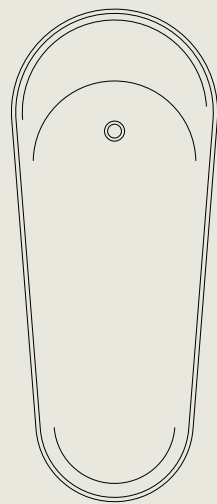

Bubbles

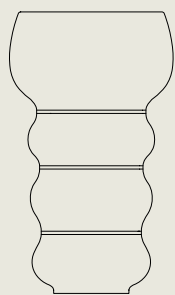

Loto n°1 & n°2



Bowl n°6



Roma

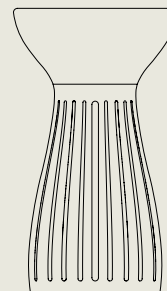

Stick

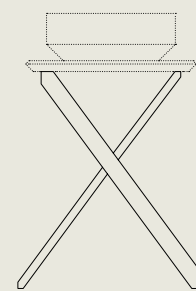

Cashmere

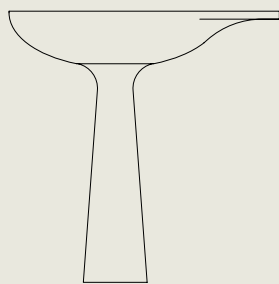

Nabhi Collection:
Bowl n°1

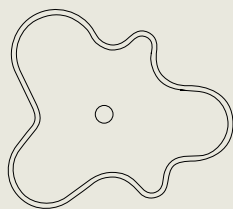

Bowl n°8

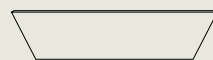

Scarlet

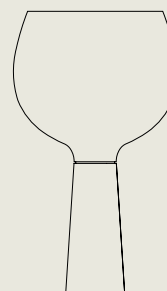

Wall Bracket

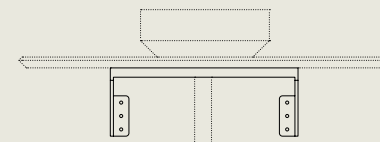

Kora

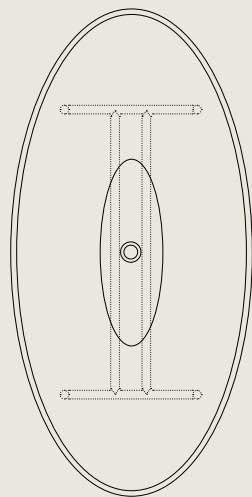

Diamond



Bowl n°2

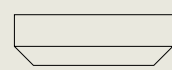

Bowl n°9



Tao

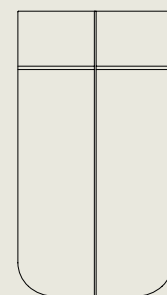

Tray

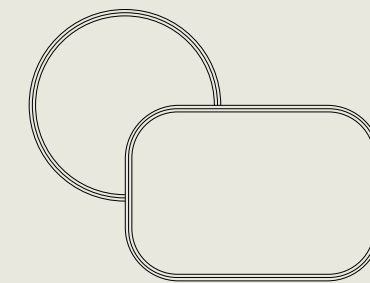

Dry

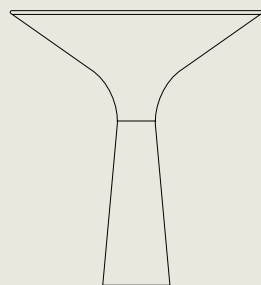

Bowl n°3

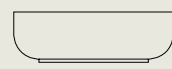

Bowl n°10

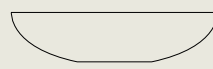

Hashi Easel

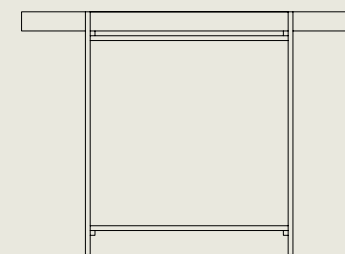

Wood Top

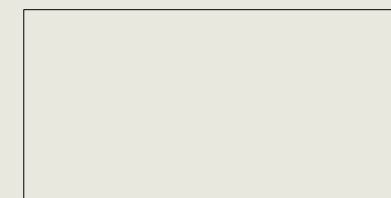

Amber

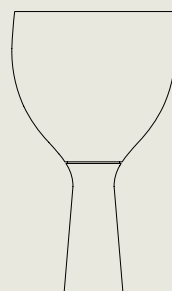

Gong

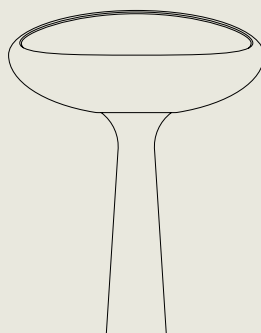

Bowl n°4

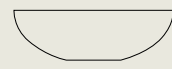

Nami

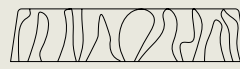

Kato Easel

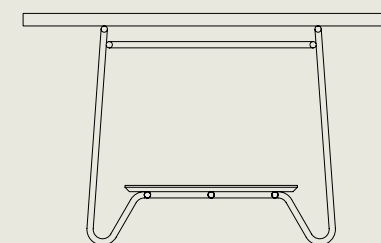

Wood Box

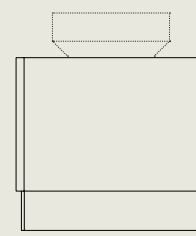

1. Bathroom Collection

Il progetto bagno di Kreoo è un universo di sensazioni tattili, estetiche e cromatiche che si esprime in un ricco vocabolario di materiali, forme e dettagli che abbraccia i luoghi del bagno in ogni loro sfaccettatura. Il mood fortemente materico di tutte le collezioni punta ad una seduzione prima sensoriale che fisica e riporta all'esigenza primordiale di un rinnovato rapporto con la natura e con il bello. Maestria artigiana e tecniche d'avanguardia danno vita ad oggetti tra design e arte che risplendono in tutta la loro naturale bellezza. Due vasche, 20 tipologie di lavabi da appoggio o free-standing, cavalletti, vassoi, più di 30 differenti marmi a catalogo: un progetto a tutto tondo che offre gli strumenti adatti per spingersi ad un alto livello di personalizzazione, per incontrare esigenze e desideri di ogni tipo di cliente. Con le sue collezioni, Kreoo riunisce la parte funzionale dell'ambiente bagno con quella emozionale, creando le basi per una salute fisica, mentale, ma anche emotiva.

Kreoo bathroom project is a universe of tactile, aesthetic and color sensations that express themselves in new shapes, facets and details. The mood, highly materic, is giving a seductive impact that recalls the renovated relation between nature and beauty. Artisan craftsmanship and updated techniques give life to design and art objects that do sparkle in their natural beauty. Two bathtubs, 20 typology of countertop or free-standing washbasins, easels and trays, more than 30 different marbles on catalogue: a complete project that offers the suitable instruments to reach a high level of personalization, to meet desires and exigencies of any kind of customer. With its collections, Kreoo draw together the functional part of the bathroom with the emotional one, creating the bases of a physical, mental but also emotional health.

Cat.

Vasca / Bathtub

Lavabo / Washbasin

Cavalletto / Easel

Contenitore / Cabinet

Top

Data sheet

105

› 114

Kalypso

Cat.
Vasca / Bathtub
Design by Enzo Berti
Year 18

Data sheet
105

Kalypso, il cui nome nella mitologia greca riporta a una Ninfa, e quindi allo stretto legame con l'elemento acqua. Kalypso riprende forme classiche antiche, che a loro volta avevano ispirato le vasche da bagno di epoca neoclassica e napoleonica. Un elemento scultoreo e materico, dalle forme morbide ed essenziali, sottolineate e impreziosite dalle venature del marmo. In Kalypso il marmo si mostra in tutta la sua forza materica, ma è al contempo mitigato dalla lavorazione, che rende delicati i movimenti ondulatori della vasca e ne sottolinea la sua morbida ergonomia, perfetta per accogliere e "cullare" il corpo umano a contatto con l'acqua. Un impatto visivo potente, ma soave.

Named for the water nymph of Greek mythology, Kalypso recalls the ancient classical forms which have inspired the bathtubs of the neoclassical and Napoleonic era. A sculptural object, with an essential yet soft shape, enriched by the unique variation of the marble veins. In Kalypso, the inherent strength of marble is contrasted by exquisite design and workmanship. Soft, undulating lines, with thoughtful ergonomics create a welcoming "embrace" for the human body in contact with water. A powerful yet gentle visual impact.



Kora

Cat.
Vasca / Bathtub
Design by Enzo Berti
Year 16

Data sheet
105

Kora ha un rimando ad uno strumento musicale tradizionale dell'Africa occidentale, caratterizzato da una forma ellittica. Il richiamo alla musica, e nello specifico al suono dell'acqua, con la sua calma, ma anche con la sua impetuosità, è la colonna sonora di un nuovo modo di vivere l'ambiente bagno dell'uomo contemporaneo, e Kora ne è la protagonista. La vasca poggia su un cavalletto in ferro che ne sostiene il volume e dona stabilità ed eleganza. Sospesa da terra, lieve alla vista nonostante la robustezza del materiale, l'acqua trova nella vasca Kora una nuova leggerezza. Il marmo si priva del suo peso e fluttua nell'aria.

Kora takes its name from a traditional musical instrument of West Africa, characterized by an elliptical shape. The reference to the music, and specifically to the sound of water, with its quiet and silent impetuosity, is the soundtrack of a new way of experiencing the bathroom, where Kora is its main protagonist. The tub rests on an iron tripod that supports its volume, giving stability and elegance. Suspended from the floor, despite the strength of the material, the water finds in Kora a new lightness. Marble is free from its weight and floats in the air.





Amber

Cat.
Lavabo / Washbasin
Design by Enzo Berti
Year 18

Data sheet
106

Tributo alla millenaria tradizione vinicola italiana, Amber è un lavabo free-standing disegnato da Enzo Berti per Kreoo, ispirato alle morbide e pulite curve dei bicchieri da vino bianco. Realizzato al 100% in marmo, Amber è l'unione di due corpi materici distinti, per rispondere ad esigenze sia di lavorazione che tecniche. Da oggetto di uso comune, il bicchiere da vino assume la consistenza del marmo e si magnifica, proiettandosi nel mondo del design contemporaneo.

A tribute to the centuries-old Italian wine tradition, Amber is a free-standing washbasin designed by Enzo Berti for Kreoo, inspired by the soft, clean curves of white wine glass. Sculpted from solid marble, Amber is created by the union of two separate pieces, to both accommodate efficient manufacturing and ensure technical stability. From an object of common use, the classic wine glass takes on the consistency of marble and is magnified, projecting itself into the world of contemporary design.





Bubbles

Cat.
Lavabo / Washbasin
Design by Marco Piva
Year 18

Data sheet
106

Il nuovo lavabo free-standing Bubbles, disegnato da Marco Piva per Kreoo, nasce per esaltare la sinuosità e la dinamicità che è possibile conferire ai marmi e alle pietre: la percezione di leggerezza è tale che sembra alludere a bolle di sapone che si sprigionano nell'aria. L'inserto metallico, un raffinato dettaglio, si propone come elemento di rottura ma al contempo di continuità, ed è inoltre funzionale al sezionamento tecnico, permettendo la divisione del pezzo in moduli separati, e quindi la possibilità di lavorare su blocchi di dimensioni contenute, riducendo sensibilmente lo spreco di materiale. I moduli possono dar vita a diverse soluzioni cromatiche, creando assonanze e contrasti che giocano sulla sovrapposizione di forme e materiali. Il lavabo è stato pensato sia nella versione da appoggio che free-standing.

The new "Bubbles" washbasin, designed by Marco Piva for Kreoo, highlights the sinuosity and dynamism that can be achieved with marble and stone. Both the shape and name were inspired by the light and pleasing visual of soap bubbles floating in the air. The metal insert, a refined detail, functions both as an element of differentiation and continuity. This design feature also allows for more efficient production, as the piece can be carved from smaller blocks of stone, reducing material waste. This modular production opens new creative avenues. Different marble colors and textures can be combined in one piece, creating intriguing juxtapositions in the overlap of shapes and materials. This washbasin has been designed as both a vanity-supported vessel sink, and a free-standing version.





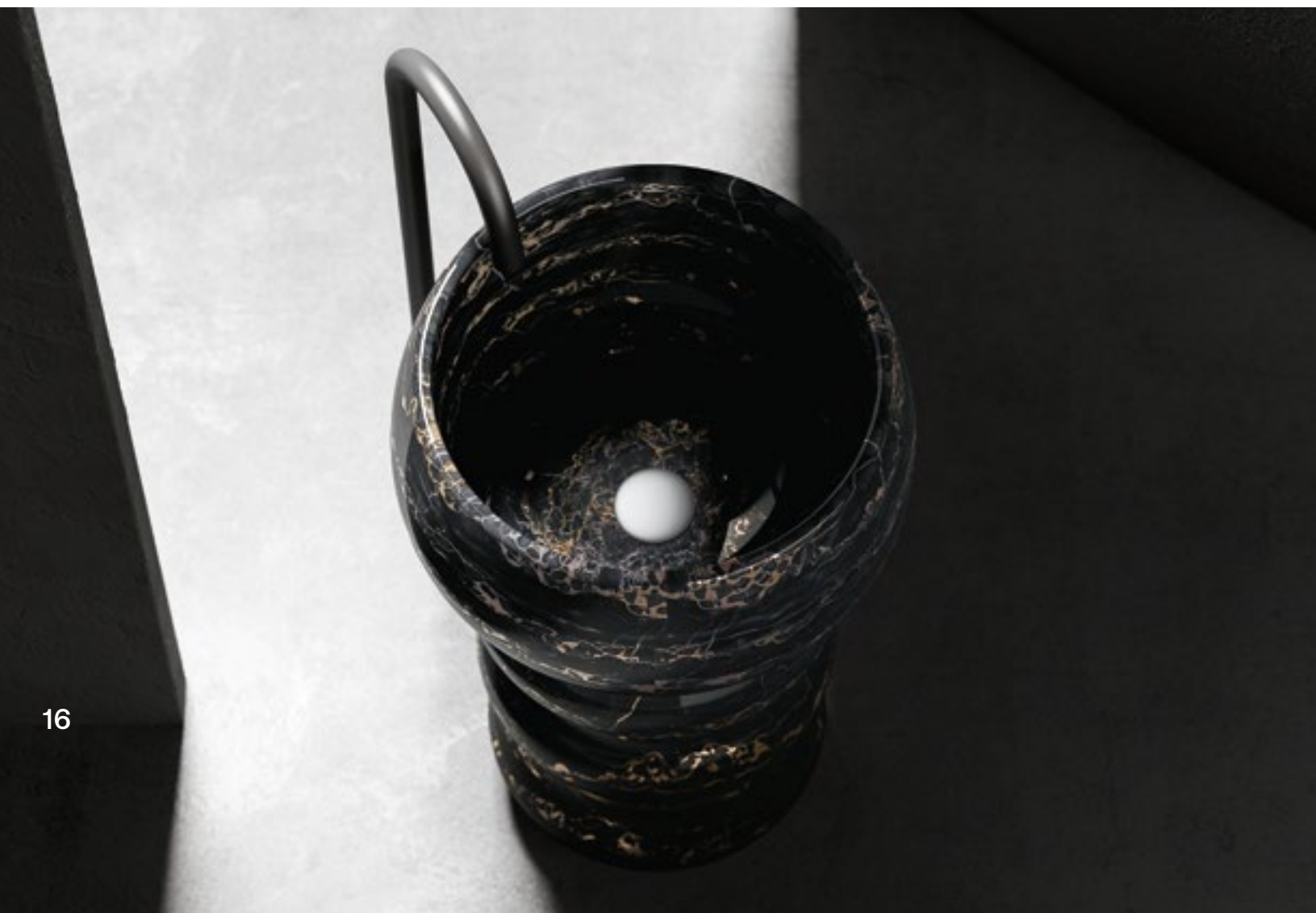



Cashmere

Cat.
Lavabo / Washbasin
Design by Enzo Berti
Year 13

Data sheet
106

Cashmere è un raffinato lavabo dove l'ovale della ciotola è prolungato per diventare una superficie estetica atta ad accogliere oggetti funzionali od ornamentali, un guizzo creativo che lo rende unico. Una forma sinuosa che si confronta con un magnifico marmo che dona a Cashmere una rara potenza espressiva. L'estetica del lavabo è esaltata dalla sostanza del marmo, la leggerezza è data dalla forma e dal gioco di venature e traslucenza del marmo, una fioritura cromatica di armoniose sfumature. Disponibile in numerose tipologie di marmo, Cashmere è un lavabo dal tocco vellutato proposto in appoggio a top in legno o in marmo, su consolle in marmo o in versione free-standing.

Cashmere is a refined washbasin where the oval shape of the basin has been extended to become a surface for functional and ornamental objects; it is like a creative twist that makes it unique. The sinuosity of the shape compares with a magnificent marble that gives Cashmere a rare expressive power. The marble substance has emphasized the basin aesthetic and the shape gives the lightness, and by the veins game. It is like a color bloom of harmonious shades. It is available in various kinds of marbles. Cashmere is a velvety touch washbasin that has been proposed leaning against wooden or marble top, or on a marble console or in free-standing version.





Diamond

Cat.
Lavabo / Washbasin
Design by Paolo Ulian
& Moreno Ratti
Year 18

Data sheet
107

Diamond è un lavabo caratterizzato dalla frammentazione ottica della superficie: un gioco visivo di geometrie attraversa la dura superficie del marmo. Diamond nasce dall'iconografia tipica della pietra preziosa, richiamata dal taglio triangolare deciso che crea diverse sfaccettature e che, come il diamante, si presenta in varie forme e dimensioni. Un'ulteriore peculiarità del lavabo è che per entrambe le misure è stata studiata una versione più inclinata, per un design più contemporaneo o semplicemente per facilitarne l'accessibilità, utilizzando la sfaccettatura come base di appoggio, e donando leggerezza visiva a un materiale pesante.

Diamond is a washbasin characterized by the fragmentation of the optical surface: a visual game of geometries that cross the hard surface of the marble. Diamond was born by the iconography of the typical gemstone, with a clear triangular cut that creates different facets and that, like a diamond, comes in various shapes and sizes. A further peculiarity of Diamond is that for both sizes a more inclined version has been studied, giving these washbasins a more contemporary design or just to make it easier to use them. The facet is used as a base, giving visual lightness to a material that is historically heavy.





Dry

Cat.
Lavabo / Washbasin
Design by Enzo Berti
Year 10

Data sheet
107

Forme pure, superfici che si fondono nell'elemento marmo che ne esalta le qualità sensoriali. Dry (nome che fa riferimento alla coppa in cui viene servito il famoso cocktail Martini Dry e dalla quale si ispira la forma) è un lavabo la cui nobile semplicità ne esalta la grazia e l'eleganza, dove il volume puro del marmo disegna forme e curve. L'inserimento di un anello di pietra a contrasto lungo il bordo superiore completa un oggetto dalla massima funzionalità d'uso quotidiano ma che si distingue come pezzo di design. Dry è proposto in 7 diverse tipologie di marmo levigato. Sul bordo superiore, a sottolineare le linee, è innestato un cerchio in marmo abbinato. Dry è destinato sia al canale Home sia al Contract.

Pure shapes and surfaces blend in the marble element and exalt its sense characteristics. Dry (named after the typical glass of Martini Dry) is a noble and simple sink, where the pure volume of marble draws shapes and lines. The insertion of a stone ring all along the upper profile completes the functionality of the object and makes it a design object. Dry is proposed in 7 marble kinds, always honed. On the upper profile the marble ring underlines its shape. Dry is directed both to Home and Contract.







Gong

Cat.
Lavabo / Washbasin
Design by Enzo Berti
Year 13

Data sheet
107

Incontro tra acqua e materia. Gong è un lavabo da appoggio, una forma pura modellata nel marmo che ne evidenzia l'eccellenza progettuale ed esecutiva. Il nome e la forma di Gong rimandano alle campane tibetane, antichi strumenti musicali buddisti, capaci di evocare molte sensazioni. In Gong la consueta conformazione del sasso ellissoidale è stata interpretata con un taglio diagonale: ne risulta un ovale scavato con una tecnica minuziosa e finissima, un corpo unico, essenziale che nei materiali chiari risulta quasi opalescente. Disponibile con verniciatura interna che ne esalta l'eleganza.

Meeting between water and substance. Gong is a purely shaped washbasin where marble pure shape emphasizes its design and aesthetic excellence. The name and shape of Gong recall the Tibetan bells, ancient Buddhist musical instruments, able to evoke many feelings. In Gong the usual ellipsoidal shape has been interpreted with a diagonal cut; the result is an oval hollowed with meticulous and fine technique, an essential body that seems nearly opalescent thanks to the softness of its colours. Available with internal painting that magnifies its elegance.





36

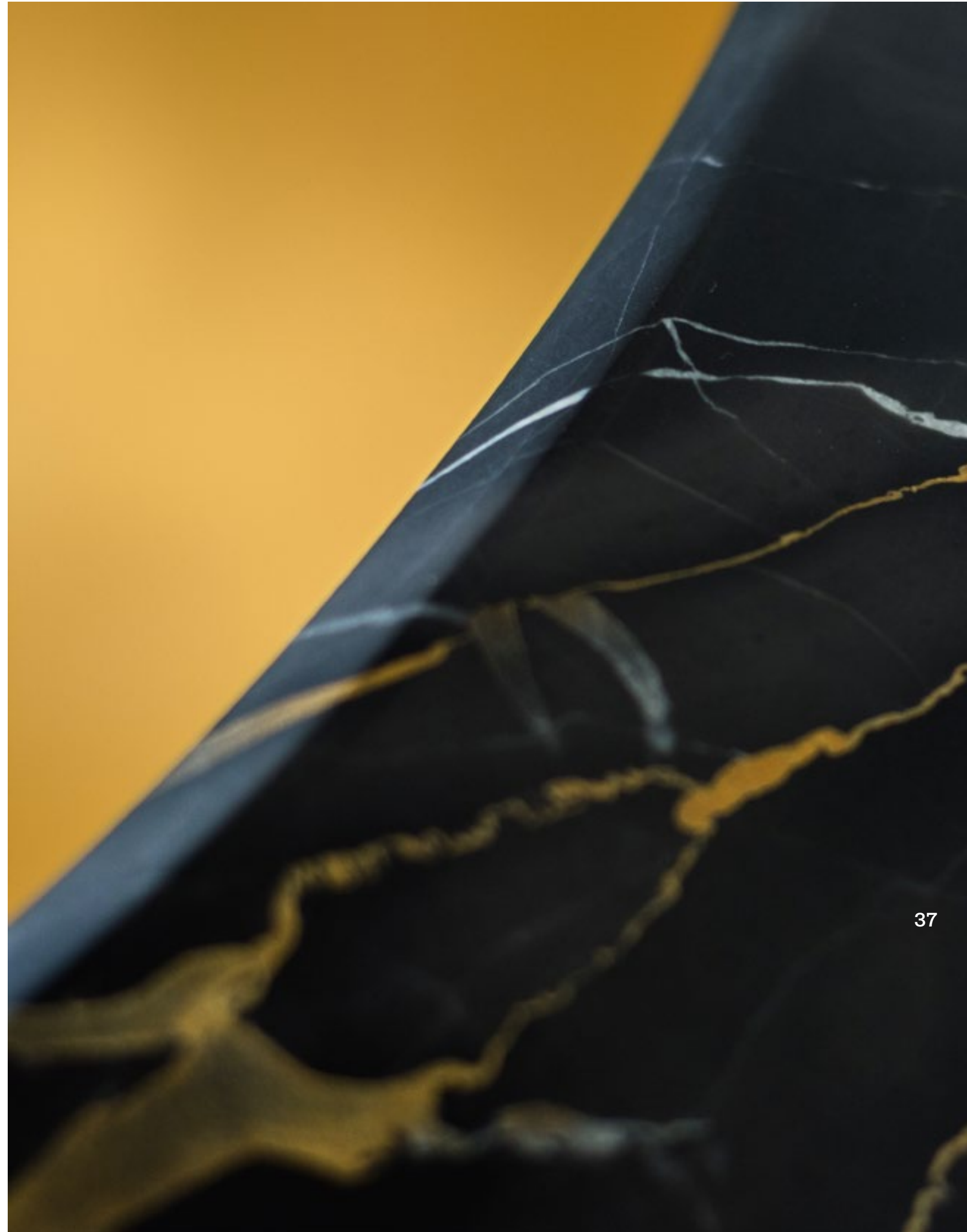

37







Loto n°1 & n°2

Cat.
Lavabo / Washbasin
Design by Enzo Berti
Year 10

Data sheet
108

Loto riporta alla memoria forme archetipiche rivisitate in chiave contemporanea. Il forte impatto scultoreo di questo lavabo consente anche un inedito utilizzo al centro della stanza da bagno grazie ad un'attenta progettazione che prevede un cavalletto free-standing oltre che ad una collocazione più tradizionale a parete (su cavalletto o appoggiato su un piano). L'ampio catino è un volume in marmo dalle linee pulite e naturali, che si presenta in due versioni, con o senza base di appoggio. Sostenuto con grazia e leggerezza da un cavalletto nella versione free-standing, ne risulta un design puro, che mette in luce la straordinaria capacità scenografica del binomio marmo-legno.

Loto brings back to modern archetypal shapes. The sculptural effect of this bowl allows its use in the center of the room thanks to a careful previous project that foresees a free-standing easel rather than a more traditional position against the wall (on an easel or countertop). The large bowl presents essential lines. It is available in two versions: with or without a wooden easel. Both versions reflect the ideal of pure design and exalt the beautiful composition that is created by matching marble and wood.





Nabhi Collection

Cat.
Lavabo / Washbasin
Design by Enzo Berti
Year 10

Data sheet
108
> 110

Nabhi è la poliedrica collezione di lavabi di Kreoo. Forte matericità per più di 350 diverse combinazioni tra modelli, tipologie di sostegno, finiture e colori per un insieme di oggetti che gioca sull'istintiva espressività di elementi naturali come il marmo, legno e particolari finiture. Ricercati marmi a catalogo, dai preziosi Bianco Carrara e Calacatta Carrara alla suggestiva e bellissima Sodalite Blu, dipingono Nabhi, una collezione dedicata al Contract (hotellerie, aree wellness etc.) e alla Casa che comprende:

- ① Un sistema flessibile di elementi di arredo bagno composto dal binomio vassoio/ciotola declinabile in molteplici misure e forme che vivono insieme o separate.
- ② Sospesi (con staffa a muro), appoggiati su una struttura a cavalletto porta vassoio in legno di larice in diverse finiture, posati su una consolle in marmo o sopra mobiletti di contenimento in larice o marmo/larice: Nabhi permette interpretazioni architettoniche inedite e altamente personalizzabili adatte ad ogni tipo di esigenza e spazio.
- ③ Diverse e preziose le nuovissime finiture a catalogo che rendono ancora più flessibili e personalizzabili tutti i modelli di Nabhi attraverso inedite lavorazioni interne dai colori accesi o con materiali preziosi come la Foglia d'Oro che conferiscono all'elemento nuove prospettive di volume.
- ④ Ogni singolo pezzo di Nabhi si caratterizza per l'equilibrio delle proporzioni e per la dinamica leggerezza delle lavorazioni. Un sapiente mix di forme e funzione dove maestria artigiana e tecniche d'avanguardia danno vita ad oggetti che risplendono in tutta la loro naturale bellezza per un risultato che esalta la purezza del design e la forza espressiva del marmo.

Nabhi is a polyhedral collection of washbasins. More than 350 different combinations among models, supports, finishing and colors constitute a group of items that play with the expressivity of natural elements, such as marble, wood and particular finishing. Elite catalogue marbles, from the precious Bianco Carrara and Calacatta Carrara to the most suggestive and beautiful Blue Sodalithe depict Nabhi, a delicate collection dedicated to Contract (hotellerie, wellness etc.) and Home that include:

- ① A flexible system of furniture for bathroom characterized by the binomial tray and bowl and declinable into various sizes and shapes.
- ② Hanging on a wall bracket, or laid on a larch easel with tray, on a marble consolle or on furniture: Nabhi allows many and personalized architectural interpretations' as per different exigencies and available space.
- ③ The new finishing make all the shapes even more flexible and customizable through inedited processing with bright colors or precious materials such as Gold Leaf, that give new perspectives, volume.
- ④ The balance of proportions and the dynamic lightness of workmanship characterize each single item. A wise mixture of shapes and functions where artisanship and technology give life to items that shine in all their beauty and exalt design purity and marble expressivity.



Bowl n°1



Bowl n°6



Bowl n°2



Bowl n°8



Bowl n°3



Bowl n°9



Bowl n°4



Bowl n°10

Bowl n°1



Kreoo







Bowl n°2



56

Kreoo



57







Bowl n°6



64

Kreoo



65

Bowl n°8



66

Kreoo



67

Bowl n°9



Kreoo



Bowl n°10



70

Kreoo



71

Nami

Cat.
Lavabo / Washbasin
Design by Enzo Berti
Year 16

Data sheet
110

Nami, il cui significato in lingua giapponese significa “onda”, è un lavabo da appoggio dalla forma ovale, le cui sinuosità ricordano i drappeggi di un tessuto: il marmo viene plasmato con minuzia scultorea, andando a creare morbide onde sulla parete esterna. Il riferimento nasce dalla storia dell’arte figurativa italiana, e più precisamente dal monumentale drappeggio della Pietà di Michelangelo, all’effetto di “caduta” del marmo nel vestito della Vergine. Nel gioco di luci e ombre, il materiale lapideo si presenta come un materiale leggero, sofisticato e prezioso. Unico, perché Nami nasce da un processo industriale, ma viene poi modellato da sapienti mastri artigiani i quali, rendendo omaggio alla nostra millenaria tradizione scultorea, donano al prodotto il valore aggiunto dell’irripetibilità.

Nami means “wave” in Japanese and it is an oval washbasin, whose sinuosity is reminiscent of a cloth’s drapery: marble is manipulated with sculptural skills, creating soft waves on its outer side. The reference comes from the Italian figurative Art History, and more specifically from the monumental drapery of Michelangelo’s Pietà, Virgin’s dress. In the game of lights and shadows, marble is presented as a light, sophisticated and precious material. Unique, because even if Nami is born from an industrial process, is then modeled by skilled masters craftsmen who, paying tribute to the Italian ancient sculptural tradition, give the product the plus value of being unrepeatable.





74



75

Roma

Cat.
Lavabo / Washbasin
Design by Marco Piva
Year 18

Data sheet
110

Linee lucenti enfatizzano la forma scultorea del lavabo e inquadrano in precise geometrie le fantastiche e sorprendenti textures generate dalla natura. In Roma il marmo esprime essenzialità, eleganza storica, idea di un lusso raffinato ed esclusivo, che coniuga memoria e contemporaneità. Roma è armonia e contrasto, è forma e funzione fuse in un unicum fortemente estetico. Le linee sorgono dal terreno a definire il contenitore dell'acqua, una fonte che evoca la teatralità del gesto dell'abluzione. In Roma le forme del passato si proiettano nel futuro caricate di nuova forza espressiva. Pensato nella versione free-standing, ma disponibile anche da appoggio.

The bright lines of the contrasting material emphasize the washbasin's sculptural shape and unexpected textural combinations. In Roma, marble expresses a heritage of elegance, the idea of refined and exclusive luxury that combines tradition and contemporaneity. Roma offers a unique aesthetic, a combination of harmony, shape and function. The lines rise from the ground to define the water container, evoking the theatricality of the ablution ritual. In Roma, shapes of the past plunge into the future with a new expressive force. Conceived as free-standing washbasin, but also available as countertop-supported vessel sink.





78



79

Scarlet

Cat.
Lavabo / Washbasin
Design by Enzo Berti
Year 18

Data sheet
111

Il lavabo free-standing Scarlet, disegnato da Enzo Berti per Kreoo, ricorda l'elegante forma di un bicchiere da vino rosso: largo e "panciuto", con imboccatura più stretta in cima, evoca la maestosità di un vino stile "Borgogna". Un lavabo dal carattere deciso, con un impatto visivo monumentale. Come un'opera d'arte, questa scultura simboleggia un nuovo modo di vivere e percepire il bagno, da luogo di servizio a vera e propria area di relax in cui dedicarsi alla propria persona.

Scarlet free-standing washbasin, designed by Enzo Berti for Kreoo, is reminiscent of the elegant shape of a red wine glass: wider and rounded, with a narrower mouthpiece, to evoke the majesty of a wine like "Borgogna". A washbasins with strong character and visual impact. Like a work of art, this sculpture symbolize a new way of living and perceiving the bathroom, from a place of utility to a place of relaxation.





Tao

Cat.
Lavabo / Washbasin
Design by Marco Piva
Year 18

Data sheet
111

Forma scultorea, elegante, decisa. Il lavabo free-standing Tao, disegnato da Marco Piva per Kreoo, esprime la forza che scorre attraverso la materia. Un segno grafico forte, che richiama alla tradizione monumentale intrinseca nel marmo. Inserti metallici enfatizzano la forma scultorea del lavabo attraversandolo per tutta la sua lunghezza e diametro, inquadrando in una precisa geometria le textures generate dalla natura. Tao, nella sua essenzialità, sintetizza ed evoca la filosofia Taoista dello Yin e Yang, la contrapposizione tra chiaro e scuro, tra pieni e vuoti, leggerezza e pesantezza, luce e ombra. L'incontro degli opposti, in forma armonica. Il lavabo è stato pensato sia nella versione da appoggio che free-standing.

A sculptural, elegant, clean shape. Tao free-standing washbasin, designed for Kreoo by Marco Piva, expresses the strength running through matter. A strong, graphic design, which reflects marble's intrinsic dynamism. Metal inserts emphasize the washbasins' sculptural shape along its entire length and diameter, framing in an the exquisite and unique geometries of the natural material. Tao's essential design draws upon the "Yin and Yang" Taoist philosophy, involving the juxtaposition of bright and dark, full and empty spaces, lightness and heaviness, light and shadow, opposites that meet in harmony. Conceived as free-standing, Tao is also available as countertop washbasin.



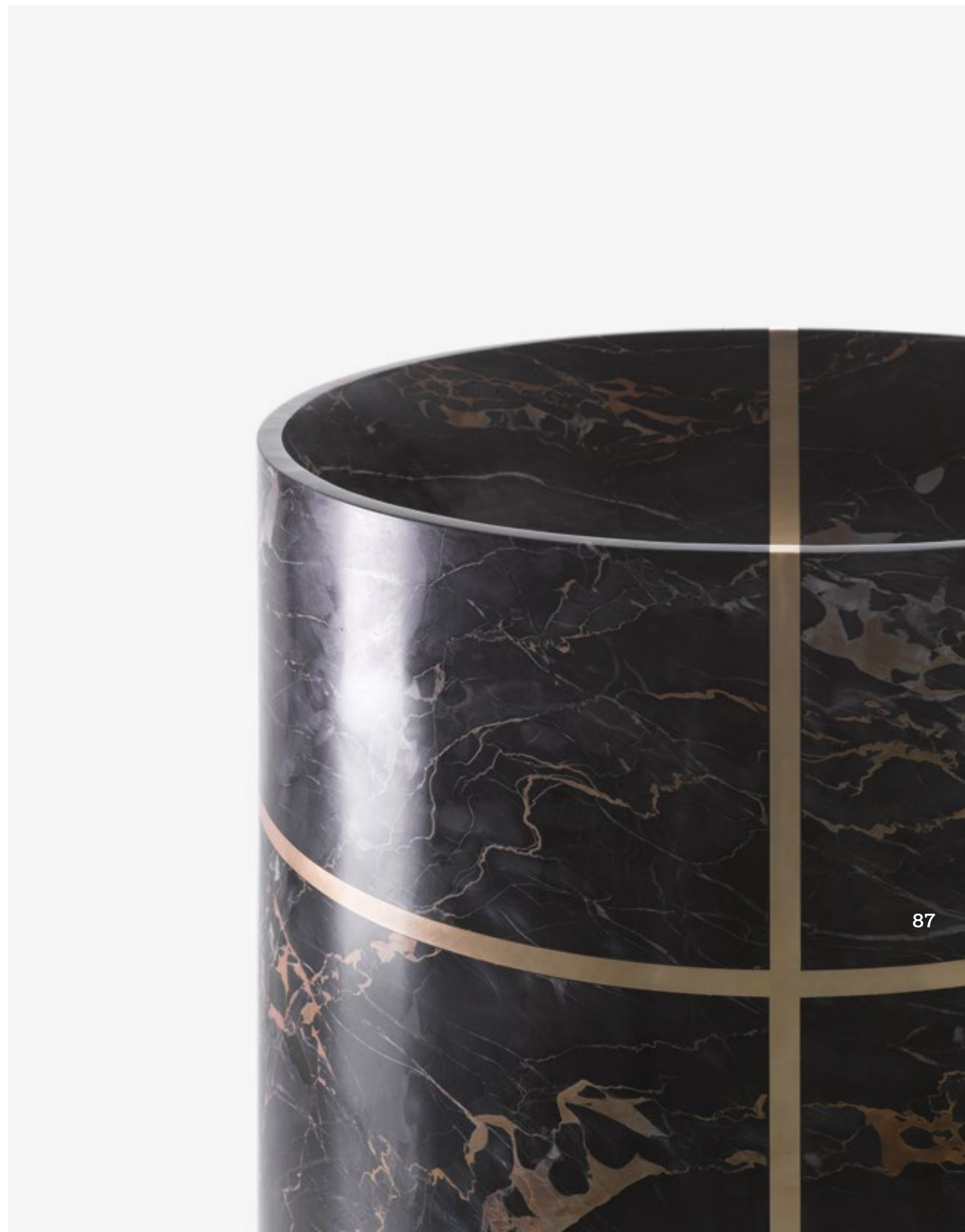



Hashi Easel

Cat.
Cavalletto / Easel
Design by Enzo Berti
Year 16

Data sheet
112

Hashi, “bacchette” in giapponese, è un oggetto dal carattere razionalista, costituito da segmenti di una barra di sezione quadrata connessi tra loro a definire un assetto geometrico puro ed essenziale. Il progetto nasce dall'incrocio delle tre barre di metallo che costituiscono la struttura. Il top è costituito da un piano in legno disponibile in diverse finiture.

Hashi, “chopsticks” in Japanese language, is a rationalist object, constituted by segments of a square section bar, connected together to define a pure and essential geometrical layout. The project stems from the intersection of the three metal bars of the structure. The top is made of a wooden top available different finishings.



Kato Easel

Cat.
Cavalletto / Easel
Design by Enzo Berti
Year 16

Data sheet
112

Il cavalletto Kato, “carrello” in giapponese, si ispira alla memoria: una forma sinuosa che spezza la rigidità del metallo, un recupero formale dei cavalletti della tradizione, strutture tubolari che un tempo sorreggevano i catini. Il cavalletto in metallo, oltre a supportare il vassoio superiore e inferiore, è stato studiato per poter ospitare anche la funzione di porta salviette. Il top può essere costituito dai vassoi in marmo delle collezioni Kreoo o da un piano in legno disponibile in diverse finiture, mentre alla base si aggiunge un ulteriore supporto in marmo per avere un secondo piano di appoggio, a scelta tra i colori della collezione Nabhi.

Kato, “cart” in Japanese language, is an easel inspired by the tradition: a sinuous shape that breaks the rigidity of metal, a formal recovery of traditional easels, tubular structures that once supported the basins. The metal easel, in addition to supporting the upper and lower tray, has been designed in order to accommodate the towels. The top can be constituted from the trays of Kreoo marble collections or a wood top, while the base has an additional support in marble that can be chosen between the colors of Nabhi collection.





Stick

Cat.
Cavalletto / Easel
Design by Enzo Berti
Year 10

Data sheet
112

Stick, il fascino del marmo abbinato al legno. Stick è un cavalletto in legno con una forma molto pulita, ad "X", un sostegno minimalista, che si apre come una sdraio, garantendo il minimo ingombro quando è chiuso. Un dettaglio di design molto ricercato risiede nelle viti di pistaggio, disegnate ad hoc per l'azienda. Il cavalletto, con la sua particolare resistenza, può essere utilizzato per ospitare i lavabi delle collezioni bagno o come oggetto di arredo autonomo.

Stick, the charm of marble combined with wood. Stick is a wooden easel with a very clean structure, an "X", a minimalist support, which opens like a deck, ensuring minimal space occupation when closed. A detail of a sophisticated design lies on the screws, designed specifically for Kreoo. Stick, with its special resistance, can be used to host the basins of Kreoo bathroom collections or as an autonomous object of furniture.



Wall Bracket

Cat.
Cavalletto / Easel
Design by Enzo Berti
Year 16

Data sheet
112

La staffa in acciaio studiata da Kreoo si configura come supporto quasi invisibile per i vassoi della collezione Nabhi. Opzionalmente, il sistema è integrabile con un porta salviette, studiato ad hoc per integrarsi con la staffa. Particolarmente adatta in caso di rubinetteria a muro, la staffa Kreoo dona all'intero ambiente bagno un senso di leggerezza e sofisticata eleganza.

The metal bracket system studied by Kreoo is an almost invisible support for the trays of Nabhi collection. Optionally, the system is integrated with a towel-holder, designed specifically to integrate with the bracket. Particularly suitable in case of wall taps, Kreoo bracket gives the whole bathroom environment a sense of lightness and sophistication.



Wood Box

Cat.
Contenitore / Cabinet
Design by Enzo Berti
Year 13

Data sheet
114

Geometrie, rigore esecutivo e flessibilità compositiva. Wood Box è una linea di mobili di contenimento modulari per il bagno che può essere utilizzato anche come base di appoggio per i lavabi delle collezioni Kreoo. I moduli sono disponibili in legno mentre il top è disponibile sia in legno che in marmo.

Geometry, rigorous execution and compositional flexibility. Wood Box is a line of modular furniture for the bathroom that also become a base for Kreoo's washbasins collection. The modules are available in wood while the top is available both in wood and marble.





Vasca
/Bathtub

Kalypso

Design by Enzo Berti
pag. 2 > 3

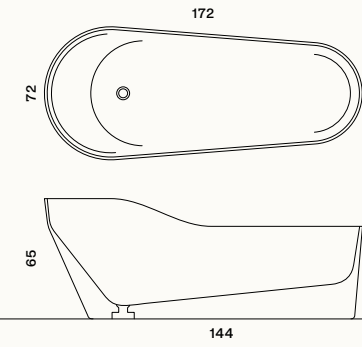

Marmo / Marble



Kora

Design by Enzo Berti
pag. 4 > 7

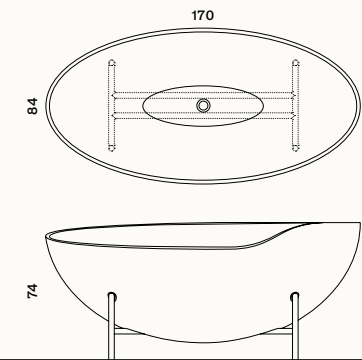

Marmo / Marble



Metallo / Metal



Lavabo
/ Washbasin

Amber

Design by Enzo Berti
pag. 8 + 11

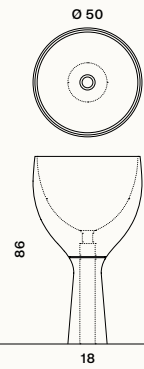

Marmo / Marble



Bubbles

Design by Marco Piva
pag. 12 + 19

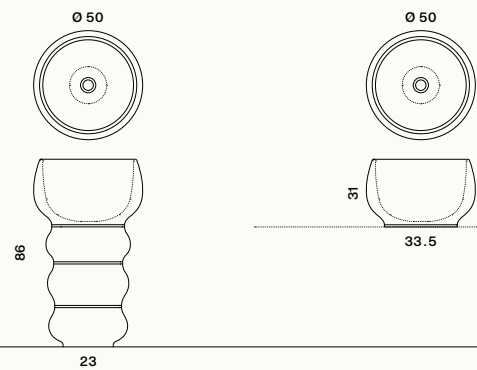

Marmo / Marble

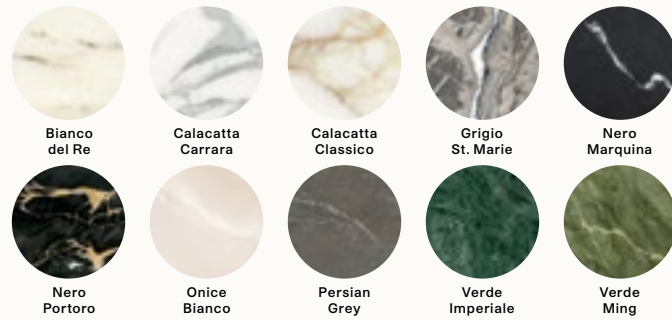

Profili / Profiles

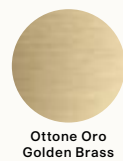

Ottono Oro
Golden Brass

Cashmere

Design by Enzo Berti
pag. 20 + 23

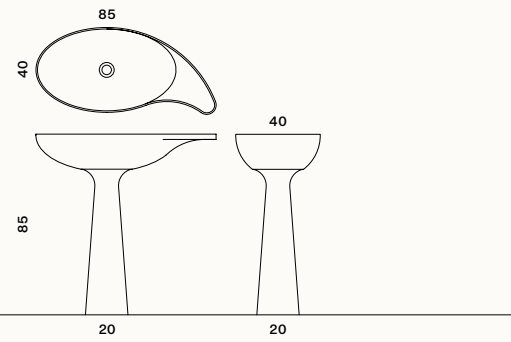

Marmo / Marble

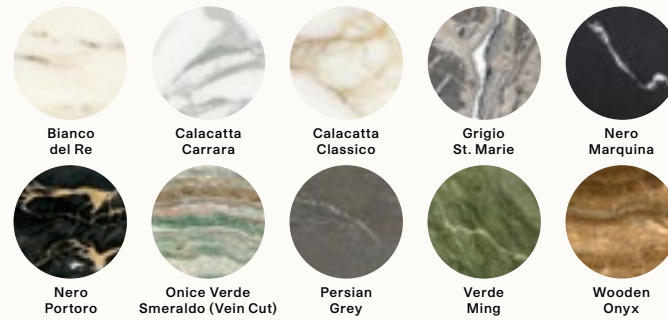

Diamond

Design by Paolo Ulian & Moreno Ratti
pag. 24 + 27

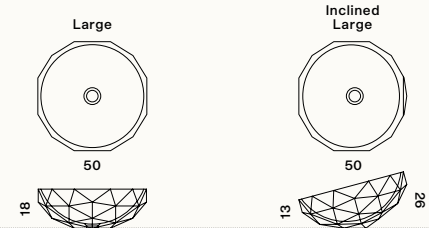
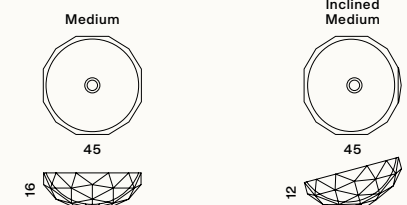

Marmo / Marble



Dry

Design by Enzo Berti
pag. 28 + 33

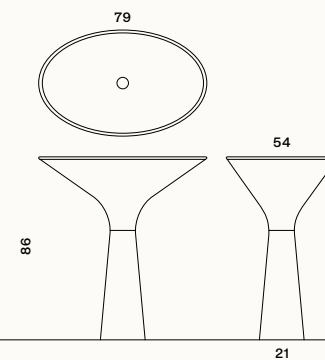

Marmo / Marble

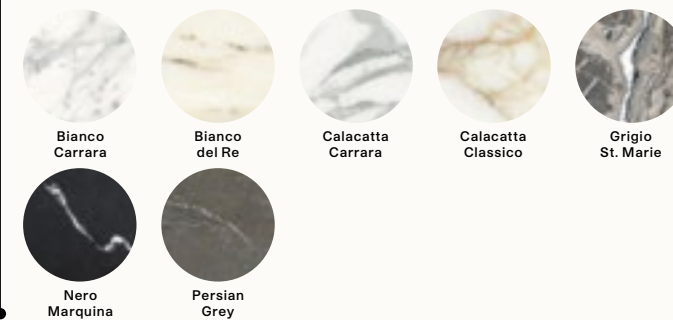

Gong

Design by Enzo Berti
pag. 34 + 43

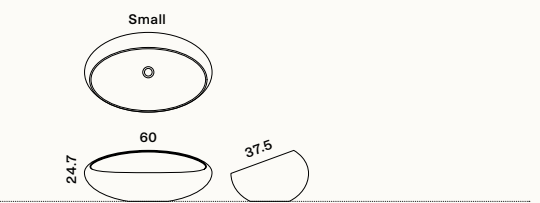
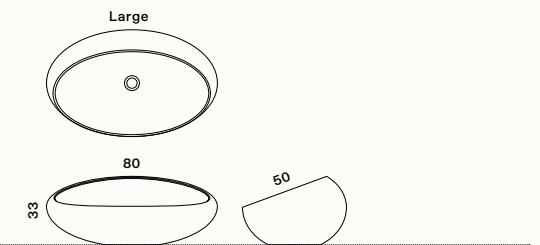
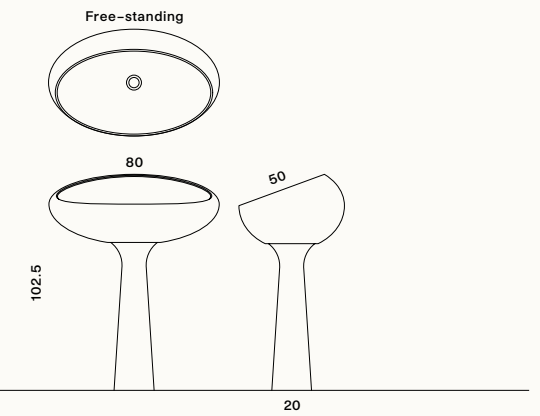

Marmo / Marble

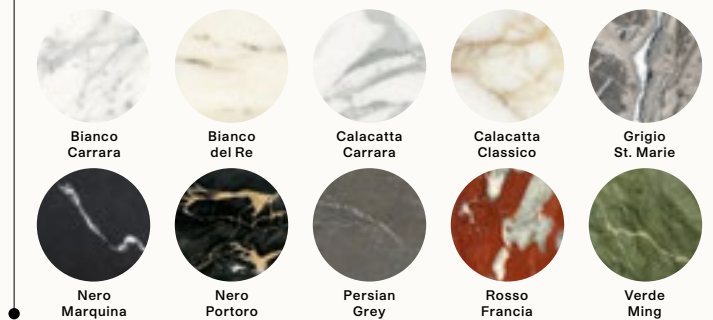

Lavabo
/Washbasin

Loto n°1 & n°2

Design by Enzo Berti
pag. 44 & 47

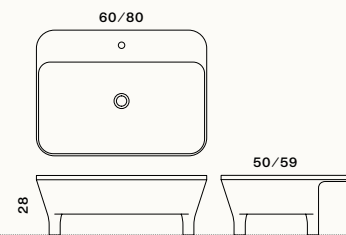
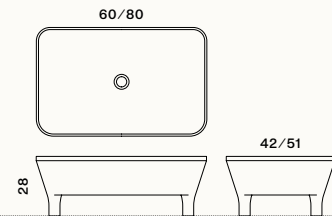

Marmo / Marble



Larice spazzolato / Brushed larch



Nabhi Collection
Bowl n°1

Design by Enzo Berti
pag. 50 & 55

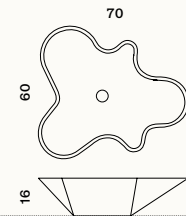

Marmo / Marble

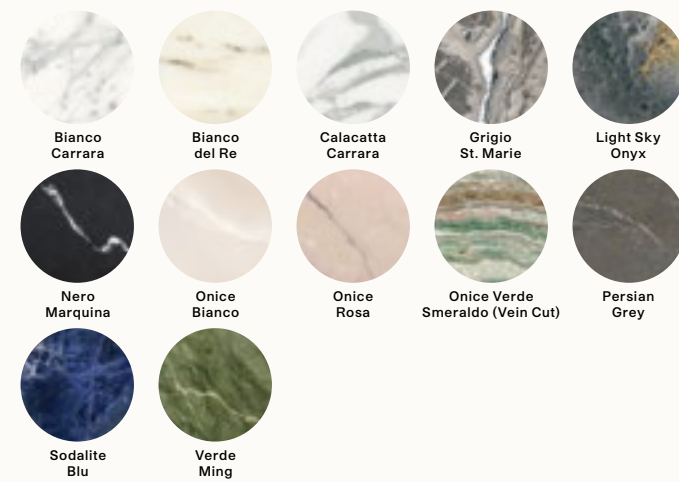

Bowl n°2

Design by Enzo Berti
pag. 56 & 57

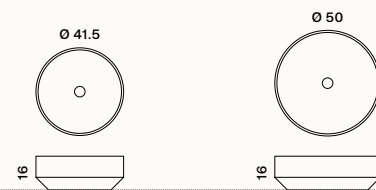

Marmo / Marble

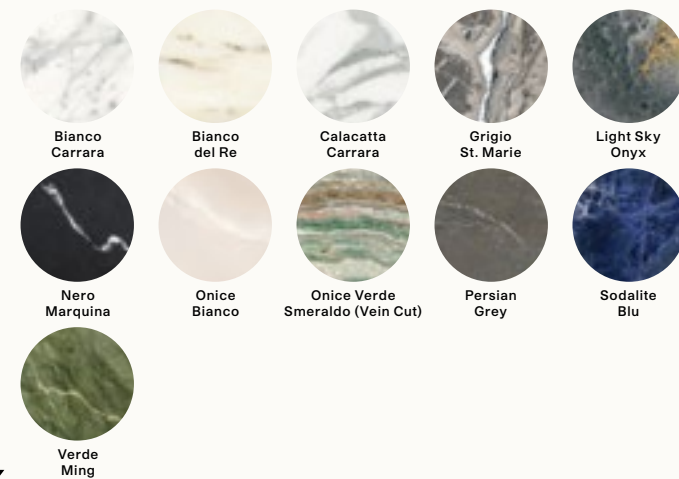

Bowl n°3

Design by Enzo Berti
pag. 58 & 61

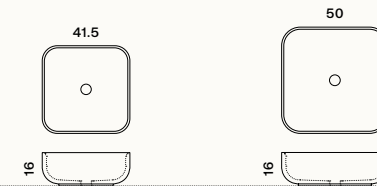

Marmo / Marble



Bowl n°4

Design by Enzo Berti
pag. 62 & 63

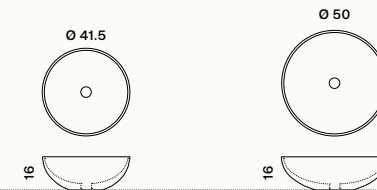

Marmo / Marble

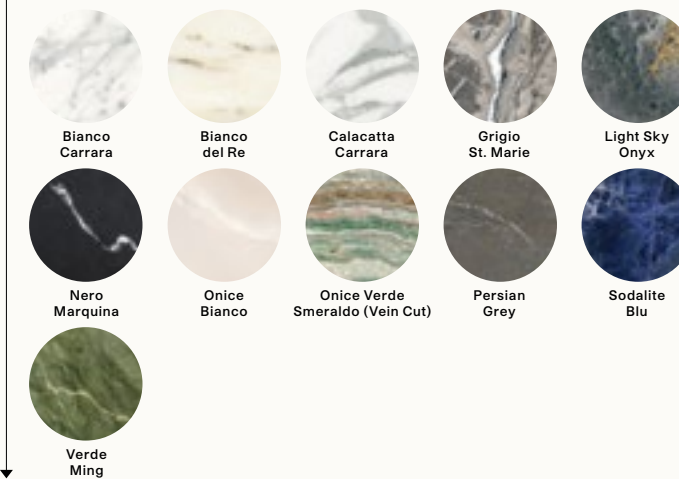

Bowl n°6

Design by Enzo Berti
pag. 64 & 65

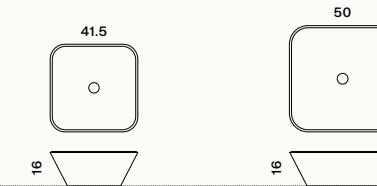

Marmo / Marble

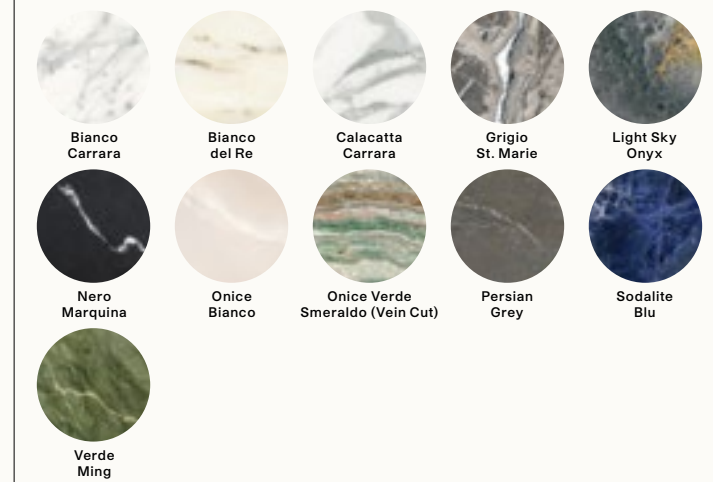

Bowl n°8

Design by Enzo Berti
pag. 66 & 67

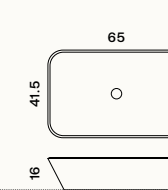

Marmo / Marble

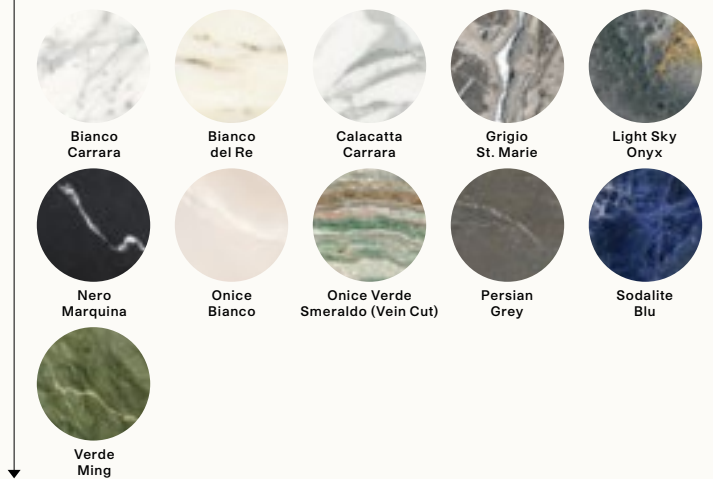

Lavabo
/ Washbasin

Bowl n°9

Design by Enzo Berti
pag. 68 › 69

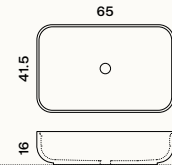

Marmo / Marble



Bowl n°10

Design by Enzo Berti
pag. 70 › 71

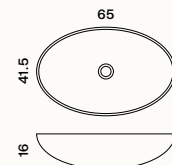

Marmo / Marble

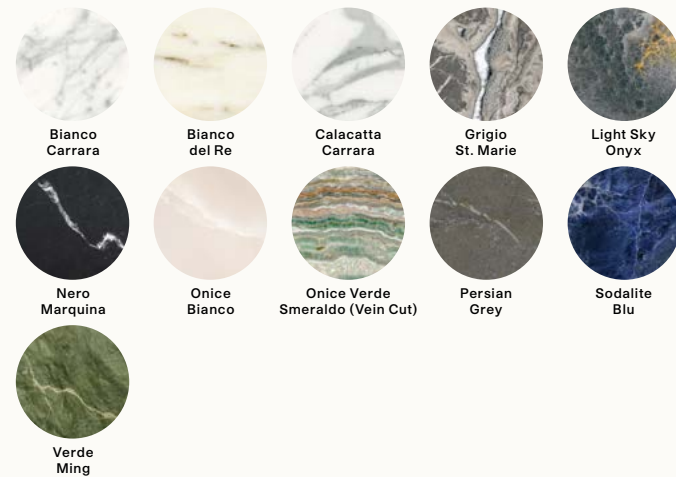

Nami

Design by Enzo Berti
pag. 72 › 75

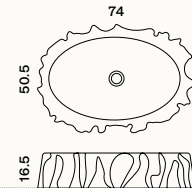

Marmo / Marble

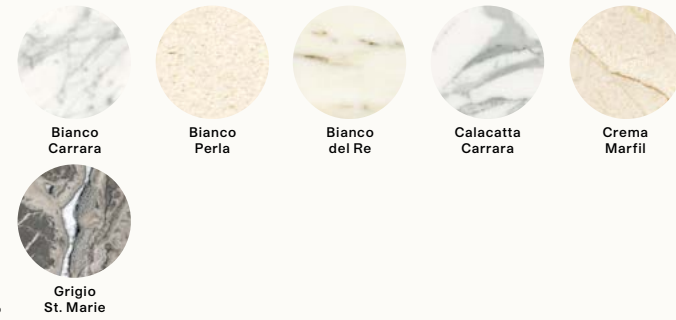

Roma

Design by Marco Piva
pag. 76 › 79

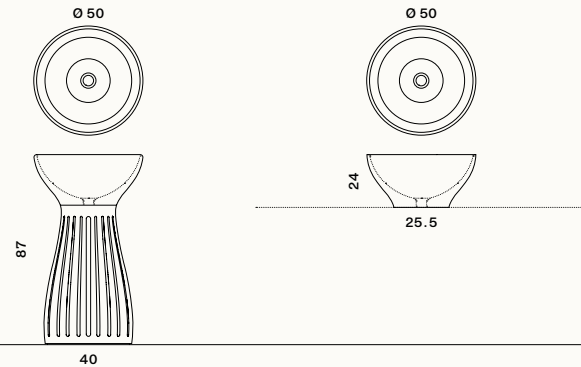

Marmo / Marble



Scalanature / Groove

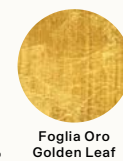

Scarlet

Design by Enzo Berti
pag. 80 › 83



Marmo / Marble



Tao

Design by Marco Piva
pag. 84 › 89

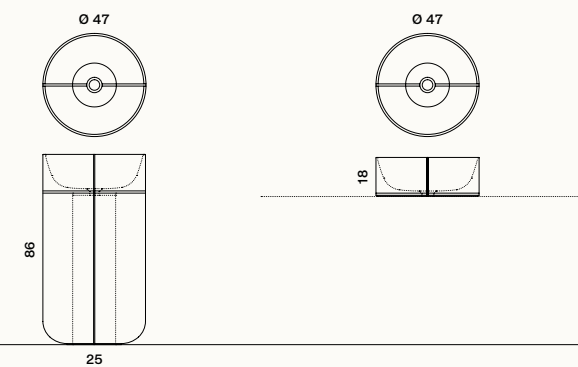

Marmo / Marble



Profili / Profiles

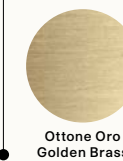

Lavabo / Washbasin
Optional Shades:

- Finitura RAL fornita lucida. / RAL color finish is provided glossy polished.
- Shade è applicabile a tutti i modelli di ciotole proposte nel catalogo. / Shade can be applied on all the shapes proposed in our catalogue.

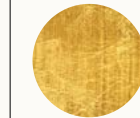

Foglia Oro
Golden Leaf



Foglia Argento
Silver Leaf



Colore Ral
Ral Color

Cavaletto
/Easel

Hashi Easel

Design by Enzo Berti
pag. 90 › 91

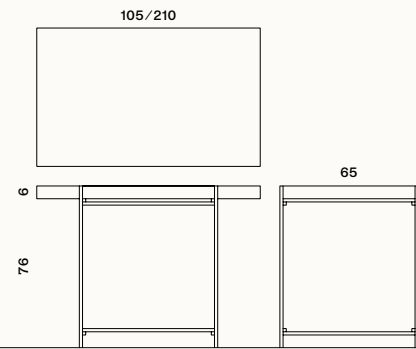

Metallo / Metal

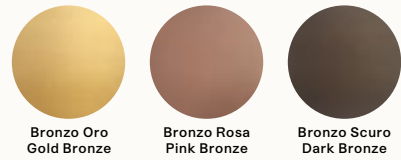

Hashi top in legno / Wooden Hashi top



Stick

Design by Enzo Berti
pag. 96 › 97

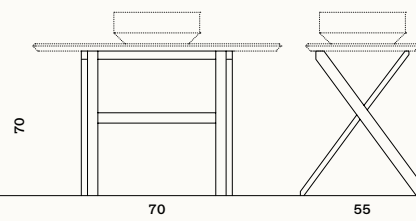

Larice spazzolato / Brushed larch



Kato Easel

Design by Enzo Berti
pag. 92 › 95

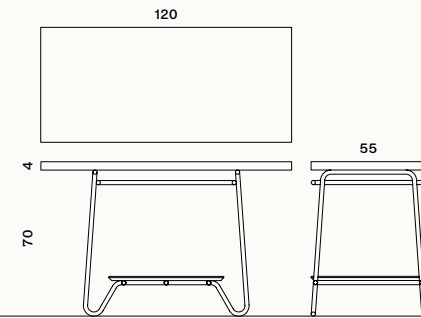

Metallo / Metal

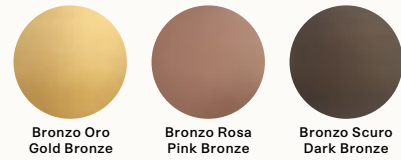

Kato top in legno / Wooden Kato top



Kato top e ripiano inferiore in Marmo / Marble Kato top and lower shelf

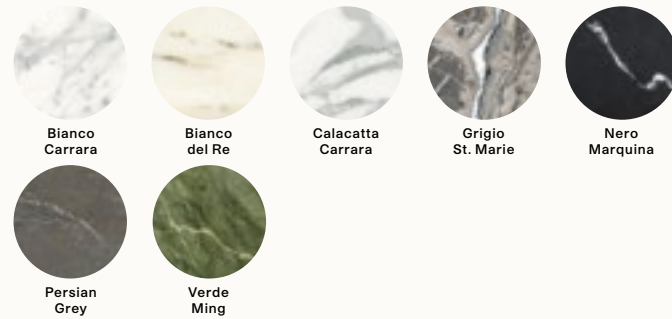

Wall Bracket

Design by Enzo Berti
pag. 98 › 99

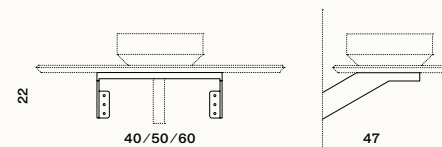

Acciaio verniciato opaco / Matt laquerel steel



Top

Tray

Design by Enzo Berti

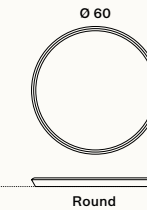

Round

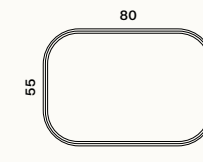

Small

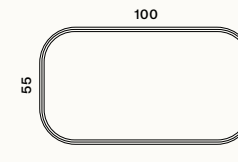

Medium

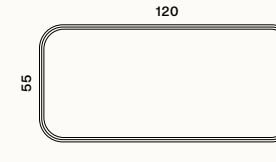

Big

Marmo / Marble

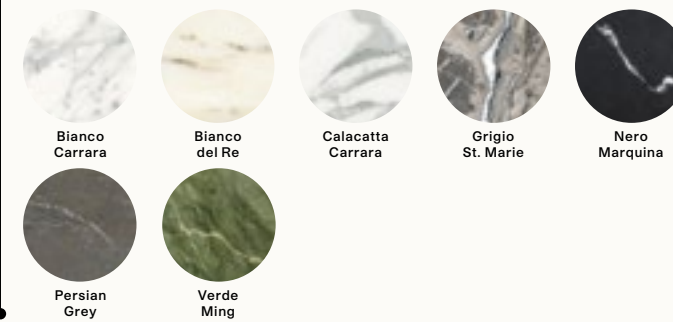

Wood Top

Design by Enzo Berti

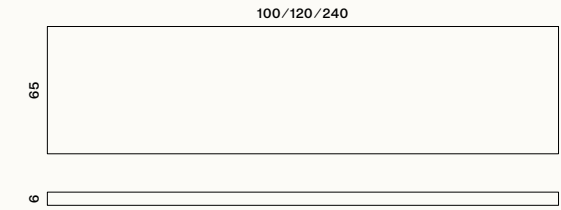

Legno / Wood



Contenitore / Cabinet

Wood Box

Design by Enzo Berti
pag. 100 - 103

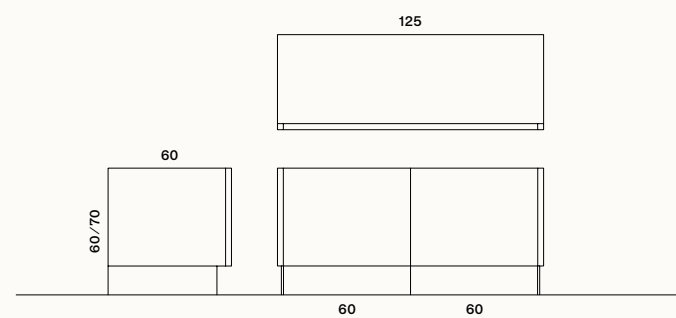
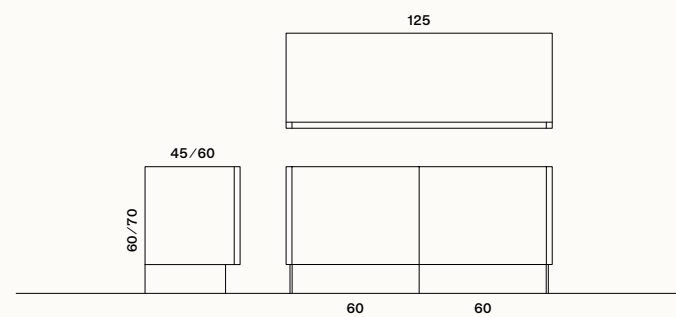
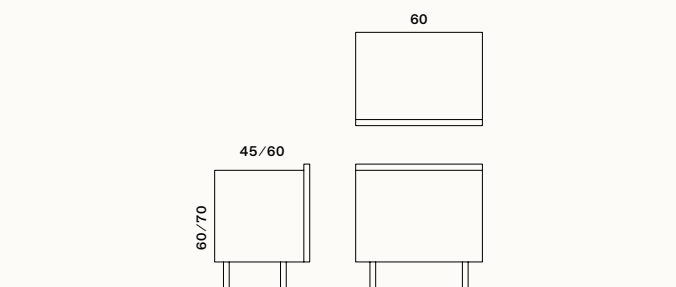

Box, Top, Zoccolo e Alzatina / Box, Top, Skirting and Risers



Top, Zoccolo e Alzatina / Top, Skirting and Risers

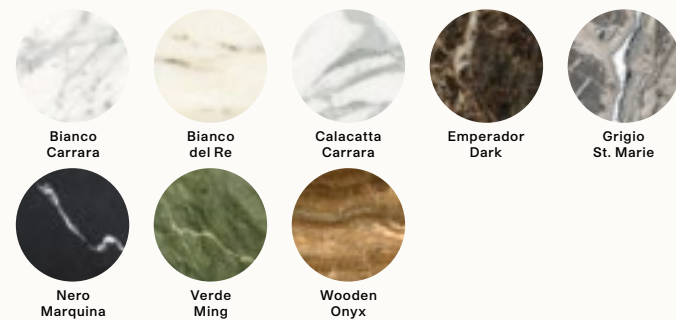

Per sua natura ogni marmo o pietra presenta colori, venature e fessure uniche, che attestano ed esaltano le qualità di naturalezza e unicità del prodotto. Kreoo si riserva la facoltà di apportare ai propri modelli qualsiasi modifica tecnica, nelle dimensioni e nei colori, ritenuta necessaria, nonché la facoltà di sospendere la produzione in qualunque momento senza preavviso, rinunziata fin d'ora da parte del committente ogni conseguente richiesta risarcitoria. Si declina ogni responsabilità relativa ad eventuali inesattezze contenute in questo catalogo, se dovute ad errori di stampa o trascrizioni.

Each marble or limestone can present different colors and veins that exalt and confirm its naturalness and uniqueness. Note: Kreoo reserves the right to make any and all necessary technical, colour or size modifications to the furniture in order to enhance its use and esthetic value, and may suspend the production cycle et any moment without notice. Such instances may not be subject to claim by the client. We decline all responsibilities for any possible uncertainties due to misprints in this catalogue.

Kreoo
Via Duca d'Aosta, n°17/e
36072, Chiampo
Vicenza - Italy
P. iva 02799900242

Ph (39) 0444 68 8311
Fax (39) 0444 68 8380
info@kreoo.com
kreoo.com

Art direction, concept
and graphic design
→ Studio Malisan

Photography
→ Tobia Berti

→ Studio Eye
(pag. 50, 51)

Image
→ Nudesignstudio
(pag. 3, 16, 17, 30, 31)

Colour separation
and printing
→ Grafiche GFP
2018

kreoo

Via Duca d'Aosta, n°17 / e
36072, Chiampo
Vicenza - Italy
P. iva 02799900242

Ph (39) 0444 68 8311
Fax (39) 0444 68 8380
info@kreoo.com
kreoo.com