

2

Arcaico, Dora, Jackie, John, Moon,
Nodo, Pedina, Torre & Torre Maxi, Tangram
Collection, Oasi, Pavé Collection, Shiro,
Vis à Vis.

Living Collection

Tavolo e Tavolino
/ Table & Coffee table

Arcaico	2
Dora	10
Jackie	16
John	20
Nodo	26

Tangram Collection:	Mini	46
	Mono	40
	Maxi	39, 42, 44

Tavolo, Tavolino e Sistema
di sedute / Table, Coffee table
& Seating system

Pedina, Torre & Torre Maxi	32
-------------------------------	----

Tavolino e Sistema
di sedute / Coffee table
& Seating system

Moon	22
Oasi	48

Pavé Collection:	Stone	53, 54, 58
	Drink	53, 57
	Log	56, 57

Libreria / Bookcase

Shiro	60
-------	----

Chaise longue

Vis à Vis	64
-----------	----

Data sheet	69
------------	----

2. Living Collection

Company

Straordinaria creatività e sperimentazione nel campo della lavorazione del marmo, Kreoo realizza arredi e complementi ad alto tasso di design per l'architettura, l'interior e l'outdoor. Il brand nasce nel 2010 sulla base della ultra cinquantennale esperienza di Decormarmi, per interpretare attraverso le sue collezioni una inesplorata dimensione dell'oggetto in marmo ed esaltarne la sua anima segreta e sensuale: in Kreoo il materiale lapideo può essere accostato ad altri elementi materici come il legno, il vetro e i metalli, creando nuove forme e spessori e donando nuove funzionalità agli oggetti del nostro vivere quotidiano. Il nome Kreoo ha un preciso riferimento al verbo greco kraino che significa "creare, realizzare": dalla Grecia classica Kreoo trae l'istinto alla perfezione e all'armonia delle forme che traduce, in Italia, in un vocabolario estetico contemporaneo e fortemente innovativo. I valori fondanti del brand sono da considerarsi nella qualità del processo produttivo, che ricerca i migliori materiali e li lavora calibrando sapientemente processi industriali alla manifattura artigiana, e nella cultura del progetto e creatività italiana, la cui trasversalità e l'interdisciplinarietà permettono la creazione di opere uniche. Particolare attenzione viene anche riservata agli aspetti di sostenibilità ambientale, riducendo il più possibile il materiale di scarto nelle lavorazioni e riutilizzandolo, ove possibile, all'interno della filiera produttiva. Il design di molti prodotti è stato affidato all'estro del designer veneto Enzo Berti, e negli anni si sono aggiunte collaborazioni con Marco Piva, Sebastiano Zilio, Paolo Ulian e Moreno Ratti. Il rapporto instaurato con i designers massimizza le capacità espressive del materiale, creando elementi in grado di possedere un'anima: oggetti forti, in qualche misura tradizionali, ma che inducono, quasi inavvertitamente, ad un progresso nel saper vedere le cose. L'azienda propone una già vasta collezione, sistemi flessibili declinati in pezzi di grande seduzione che, in alcuni casi, sono diventati icone del marchio, come il lavabo Gong, la vasca Kora, le sedute Pavè Stone o il tavolo Arcaico. Precisa, innovativa e attenta anche la scelta dei materiali: una sorta di cartella colori che predilige nuance di bianchi, grigi e neri, ma si accende anche dei bagliori dei verdi, blu, rossi, svelando sfumature e venature uniche del materiale. Kreoo è oggi distribuito a livello internazionale, con ottima copertura del territorio europeo, americano, russo e arabo, con la collocazione dei suoi prodotti nelle migliori showroom, da San Francisco a Dubai, da Mosca a Hong Kong, e fino all'Australia.

Extraordinary creativity and experimentation in the field of marble processing, Kreoo realizes furniture and accessories with high design level for architecture, interiors and outdoors. The brand was born in 2010, on the basis of the 50-year-long experience by Decormarmi, to interpret through its collections an unexplored dimension of the marble item and exalting its sensual and secret soul: in Kreoo marble can be combined with other materials such as wood, glass or metal, creating new shapes and thicknesses and giving new functionalities to the objects of our daily lives. The name Kreoo has a precise reference to the Greek verb kraino meaning "to create, to realize": from Ancient Greece, Kreoo draws the instinct for perfection and harmony and translate it, in Italy, into a contemporary, aesthetic and innovative vocabulary. The founding values of the brand are in the quality of the production process, whose research the best materials and work them by wisely calibrating industrial processes with an artisan craftsmanship, and in the Italian Design history and creativity, whose wide spread approach and interdisciplinary perspective allow the creation of unique works. Particular attention is also paid to aspects of environmental sustainability, reducing as much as possible the waste of material during the production and reusing it, where possible, within the production chain. The design of many products has been appointed to the inspiration of the Venetian designer Enzo Berti, and over the years new collaborations with Marco Piva, Sebastiano Zilio, Paolo Ulian and Moreno Ratti have been added. The relationship established with the designers maximizes the expressive capabilities of the material, creating objects that possess a soul: strong objects, in some way "traditional", that induce, almost inadvertently, to an improvement in the ability to seeing things. The company already offers a wide collection, flexible systems declined in high seduction pieces that, in some cases, have become icons of the brand, such as Gong washbasin, Kora bathtub, Pavè Stone seats or Arcaico table. Precise, innovative and careful is the choice of materials: a sort of colour palette that prefers nuance of whites, grays and blacks, but also lights up with flashes of green, blue and red, revealing unique and refined shades of the marble material. Kreoo is today internationally distributed, with a very good coverage in European, American, Russian and Arabic territories, with its products displayed in the best showrooms, from San Francisco to Dubai, from Moscow to Hong Kong, 'till the far Australia.

Arcaico

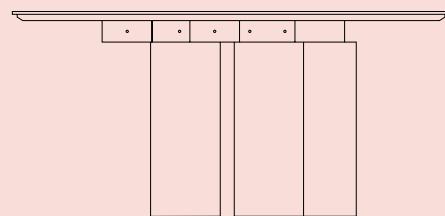

Dora

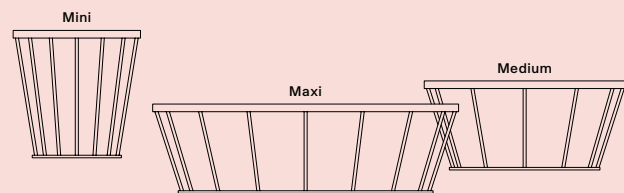

Jackie

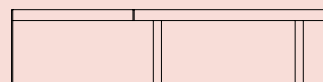

John

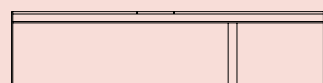

Moon

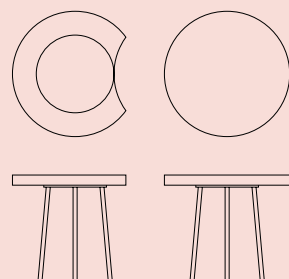

Nodo

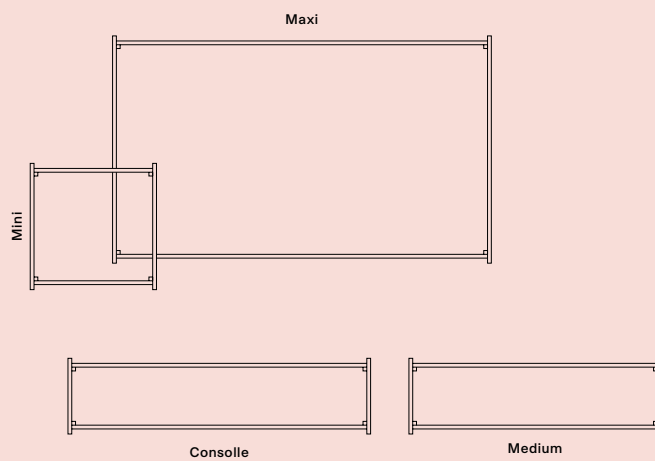

Pedina

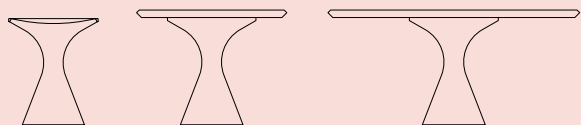

Torre & Torre Maxi

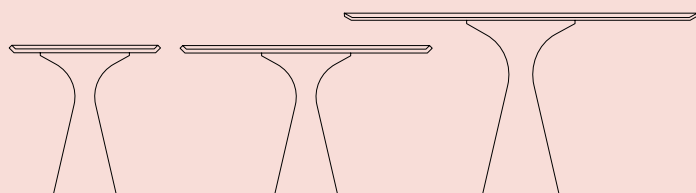

Tangram Collection:

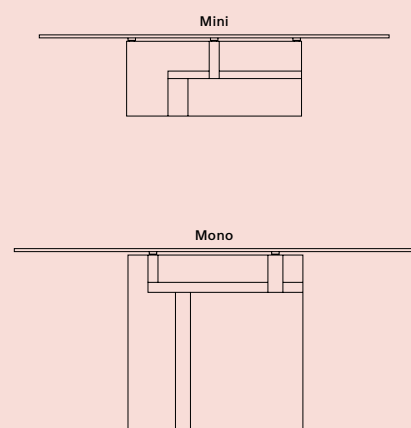

Tangram Collection:

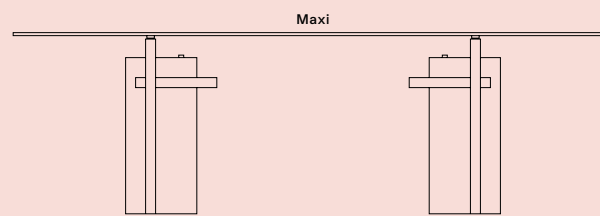

Oasi Collection:

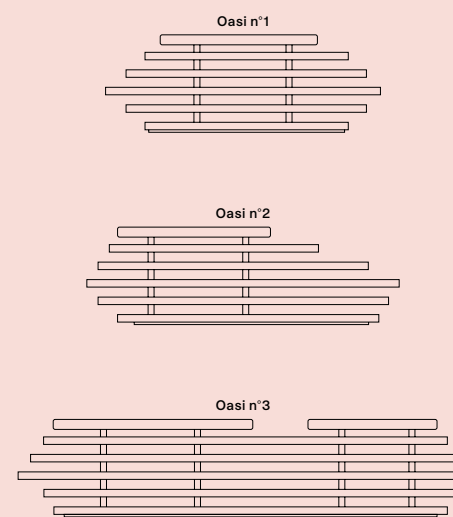

Pavé Collection:

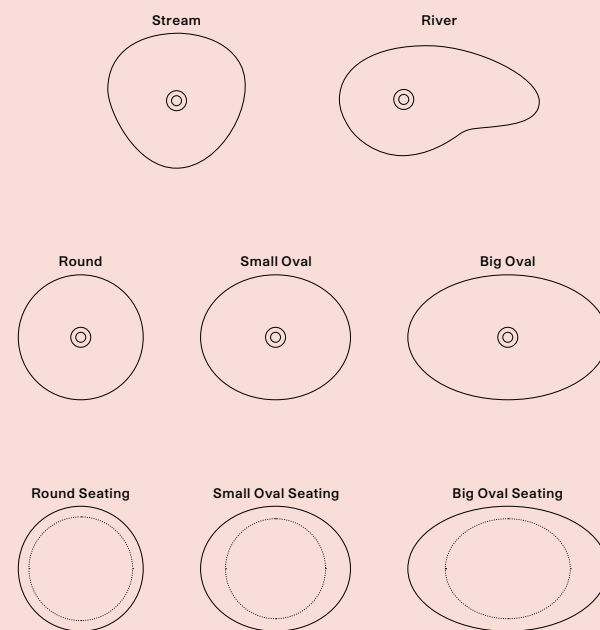

Pavé Collection:

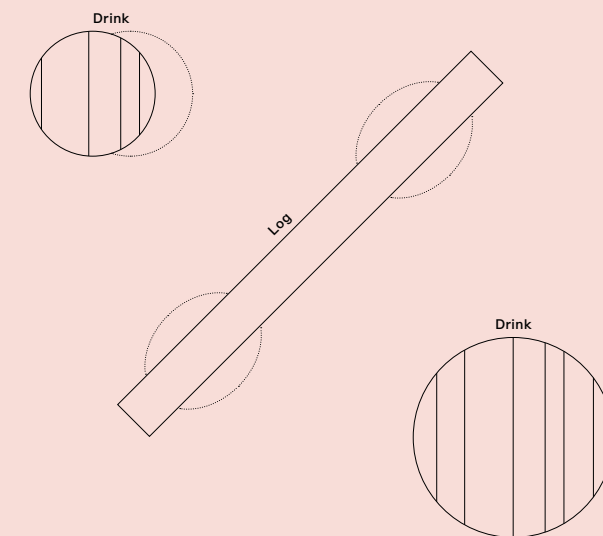

Shiro

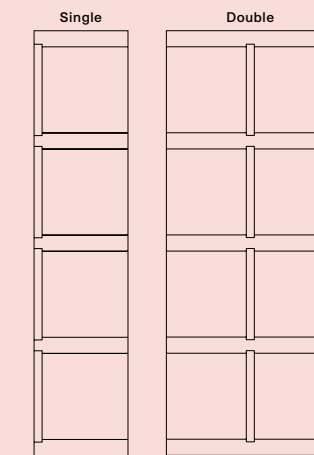

Vis à Vis

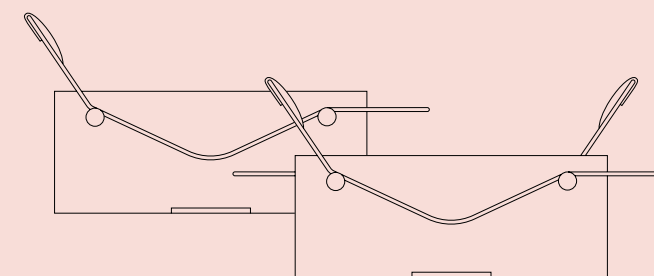

Arredi funzionali, duraturi, innovativi ed eleganti, gli elementi della collezione Living di Kreoo, spesso ispirati alle forme e al movimento perpetuo della natura, sono un tributo al marmo e alle potenzialità offerte dai materiali litici. Tavoli, tavolini, sedute da esterni o da interni, mensole e librerie, oltre alle infinite customizzazioni rese possibili dalla maestria artigiana di Kreoo: oggetti sofisticati e contemporanei non legati alle mode del momento ma a uno stile senza tempo. Una collezione contemporanea di elementi di arredo che si contraddistingue per l'elegante connubio del marmo con altri materiali come il vetro, il metallo e pietre preziose, dove innovazione, design e qualità sono protagonisti.

Functional, long-lasting, innovative and elegant furnitures, the elements in Kreoo's Living collection, often inspired by the shape and movement of nature, are a tribute to marble and the potential offered by stone materials. Tables, coffee tables, indoor and outdoor seats, bookcases, shelves, in addition to the infinite customizations made possible by Kreoo craftsmanship: sophisticated and contemporary objects not linked to current trends but to a timeless style. A collection of contemporary furnishing items with smart combinations of marble and other materials such as glass, metal and gemstones, where innovation, design and quality are protagonists.

Cat.

Tavolo / Table

Tavolino / Coffee table

Sistema di sedute / Seating system

Libreria / Bookcase

Chaise longue

Data sheet

69

> 79

Arcaico

Cat.
Tavolo / Table
Design by Enzo Berti
Year 14 - 18

Data sheet
69

Grande flessibilità d'impostazione per la collezione Arcaico, un sistema di tavoli presentato con successo nell'aprile 2014, basato su una struttura in metallo alla quale sono agganciate basi cilindriche in marmo massello che fungono da contrappesi rispetto al piano (in marmo o legno), che appare quasi sospeso nello spazio in uno slancio di dinamica leggerezza. Al Salone del Mobile 2018, Arcaico si arricchisce con basi in metallo oro, metallo bronzo e metallo rosa, e con il top in Onice Tramonto, prezioso materiale che entra per la prima volta nelle collezioni dell'azienda. Decise sfumature di arancio, verde e beige, a contrasto con la lucentezza dei metalli o la plasticità degli onici, donano un'impatto visivo onirico e accattivante.

There is a great flexibility in the definition of Arcaico collection, a system of tables successfully presented in April 2014, based on a metal structure where massive marble cylinders are hooked. These cylinders act as counterweights to the top (in marble or wood) that seems to be suspended in the space in a burst of dynamic light. At Salone del Mobile 2018, Arcaico is enriched with bases in gold metal, bronze metal and pink metal, and with the Onice Tramonto (sunset onyx) top, a precious material that enters for the first time in the company's collections. Clear shades of orange, green and beige, contrasting with the shine of the metals or the sculptural quality of the onyx, give a dreamlike and captivating visual impact.







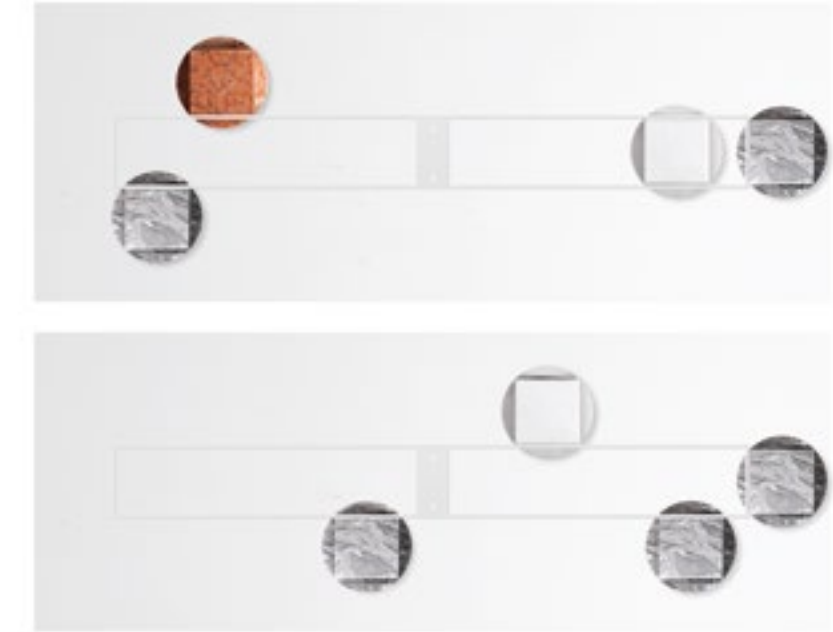

Particolarmente adatto ad ambienti Contract per concezione e struttura, il concept di Arcaico offre la possibilità di un alto livello di personalizzazione: l'insieme dei basamenti in marmo o metallo sui quali poggia il piano possono essere, a scelta, monocromatici o policromi potendo attingere dall'infinita varietà delle essenze di marmo presenti in natura. Le basi variano da un minimo di tre ad un massimo di sei a seconda della misura del piano e delle preferenze. Arcaico, un elemento d'arredo unico, una "scultura funzionale" per la zona ufficio, pranzo o living.

Thanks to its conception and structure, it is particularly suitable for Contract. The table concept offers a wide range of personalization: the group of marble or metal bases can be both monochrome and polychrome, and you can choose among various marble essences that nature offer. Bases vary from a minimum of 3 to a maximum of 6, in relation to the top sizes and to personal tastes. Arcaico, a unique furnishing item, a "functional sculpture" for the office, the dining or the living room areas.

Dora

Cat.
Tavolino / Coffee table
Design by Enzo Berti
Year 18

Data sheet
73

La nuova serie di coffee tables Dora, disegnata da Enzo Berti per Kreoo, si compone di tre elementi caratterizzati da base in ottone e piano in marmo o semipreziosi, che si differenziano tra loro per altezza, diametro e materiale selezionato per il top. La forma a barile del tradizionale tamburo Giapponese si mescola con quella conica appartenente alla tradizione dell'Africa Occidentale dello Djembè, con il suo sistema di tiraggio formato da corde e da cerchi. Il risultato è una serie di oggetti unici, dalla forte personalità sospesa tra più culture, ma dall'anima fortemente italiana.

The new Dora coffee tables collection, designed by Enzo Berti for Kreoo, consists of three models. Each table is composed of a brass base and a marble or semi-precious stone top, varying in height, diameter and proposed material. In the Dora design, the barrel shape of the traditional Japanese Doramu drum is combined with the conical shape of the West African Djembè and its system formed by ropes and circles. The result is a series of unique objects – an intersection of different cultures, with a strong Italian soul.







Jackie

Cat.
Tavolino / Coffee table
Design by Sebastiano Zilio
Year 18

Data sheet
72

Jackie, nome che rimanda a una grande personalità femminile nell'immaginario Americano, è il nuovo tavolino della collezione Living di Kreoo, omaggio agli Stati Uniti d'America, che si propone come elemento di arredo dal carattere deciso. Il marmo è, come sempre, il protagonista indiscusso. Opera d'arte in se stessa, la materia litica è il piano d'appoggio, che si configura dall'intersezione di tre elementi geometrici, sinuosi e circolari. Un'unica lastra, tagliata secondo il profilo metallico del tavolino, che interrompe con eleganza le venature del marmo, generando nuove forme, simili a chicchi di riso, o petali di un fiore.

Named for the inspirational American Icon, "Jackie" is a new table in Kreoo Living collection – A tribute to the United States of America, which proposes itself as a piece of furniture with a strong character, where marble is, as always, the protagonist. A work of art in itself, the table top is carved from a single marble slab and configured by the intersection of three geometric elements, sinuous and circular. Marble is cut according to the metal profile of the table, which elegantly bisects the veining of the marble, generating new shapes, similar to rice grains, or flower's petals.





John

Cat.
Tavolino / Coffee table
Design by Sebastiano Zilio
Year 18

Data sheet
72

Il coffee table John, disegnato da Sebastiano Zilio per Kreoo, si riferisce nel suo nome ad una grande personalità nella coscienza collettiva Americana: un carattere forte dato dai preziosi marmi selezionati, caratterizzati da venature decise. Il piano di John è composto da elementi squadrati, che derivano da un'unica lastra o da diverse, con un profilo metallico che lo seziona in modo elegante, creando un gioco di contrasti e infinite possibilità compositive. John ha infine un bordo perimetrale metallico forte, che lo incornicia come il più prezioso dei dipinti. Un gioco di geometrie, intersezioni e materiali a contrasto, che esaltano la pura bellezza del marmo.

John's coffee table, designed by Sebastiano Zilio for Kreoo, refers in its name to a great personality in the American collective consciousness: a strong character given by the selected precious marbles, characterized by decided veins. John's marble top is composed of squared elements, from a single slab or from different ones, with a metal profile that elegantly bisects it, creating a game of contrasts and endless compositional possibilities. John has finally a major metal perimeter rim, whose frame it as the most valuable of the paintings. A play of geometries, intersections and contrasting materials, which enhance the pure beauty of the marble.



Moon

Cat.
Tavolino / Coffee table
Sistema di sedute / Seating system
Design by Enzo Berti
Year 14

Data sheet
73

Intrigante e misterioso come la luna: Moon è un sistema flessibile sgabello / tavolo in marmo e legno con base in metallo dove le forme di sedute e piano tavolo ricordano le fasi lunari. Proprio come i diversi periodi della luna, il piano del tavolino è un cerchio che combacia perfettamente con i "tre quarti di luna" dello sgabello. La seduta e il tavolino d'appoggio, infatti, vivono da soli oppure possono essere agganciati l'uno all'altro ad incastro in una sorta di coreografico grappolo di sedute e piani di appoggio: visto dall'alto il sistema risulta una fioritura di diversi colori del marmo a contrasto materico con il legno.

Intriguing and mysterious as the moon: Moon is a flexible system made by stool / table in marble and wood with a metal base and the shape of the seat and tabletop recall the moon phases. Just like the phases of the moon, the tabletop is a circle that perfectly joins the "three-quarters" of the stool. As a matter of fact, the seat and the side table can be on their own or be hooked one with the other in a sort of bunch of seats and tops: if you see it from above, the system looks like a blooming of many marble colors in contrast with wood.





Nodo

Cat.
Tavolino / Coffee table
Design by Enzo Berti
Year 18

Data sheet
74

La famiglia di coffee tables e piani di appoggio Nodo è caratterizzata da elementi geometrici dalle forme essenziali, nei quali il top in marmo è sostenuto da profili in ottone lineari. L'effetto visivo è leggero e contemporaneo, le venature del marmo enfatizzano l'unicità dei singoli elementi. Un particolare significativo è l'eleganza dell'incastro angolare dei profili, in grado di sostenere il piano facendolo sembrare "sospeso" su due lati, conferendo alla solidità del materiale un'inedita leggerezza. L'effetto dell'incastro sembra un nodo, da qui il nome della collezione. Realizzati in diverse altezze e dimensioni, per un totale di quattro modelli a base rettangolare o quadrata, possono dar vita a composizioni modulari innovative o porsi come singole soluzioni di arredo.

Nodo is a multi-functional family of geometric coffee tables and shelves. Each piece is characterized by a natural marble top resting on linear brass profiles. The visual impact of the marble veining offers a light and organic feel to this contemporary collection. A significant detail of the Nodo design is the elegance of the brass profile's angular joint. This supports the stone top, while giving the appearance of the marble being "suspended" on two sides, creating an unprecedented lightness for a stone table concept. The joint design resembles a knot. In Italian, this word translates to Nodo, which became the collection name. Available in different heights, sizes and a choice of square or rectangle base, the Nodo Collection offers four models that can be installed separately or as innovative modular compositions.





28



29

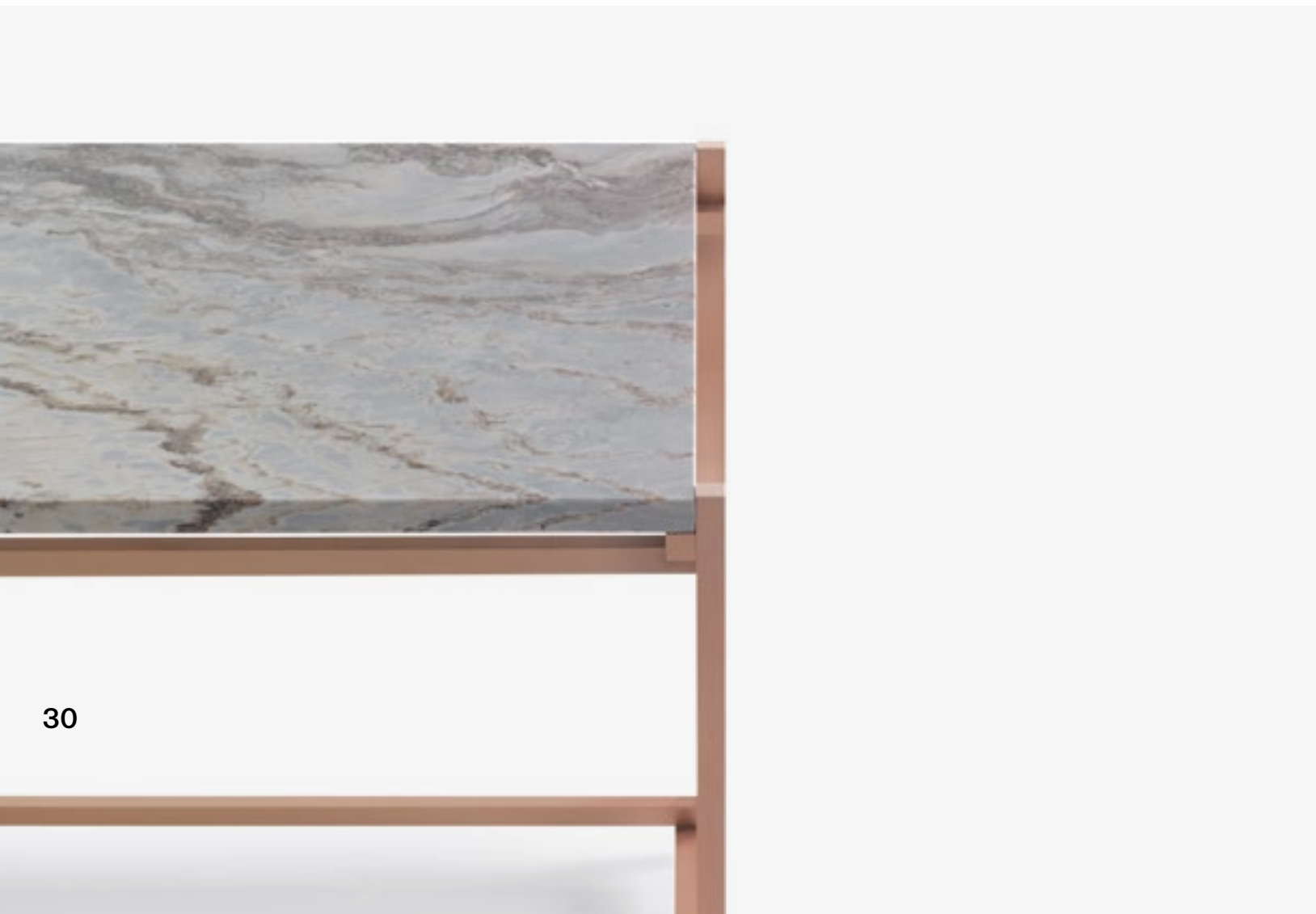

30

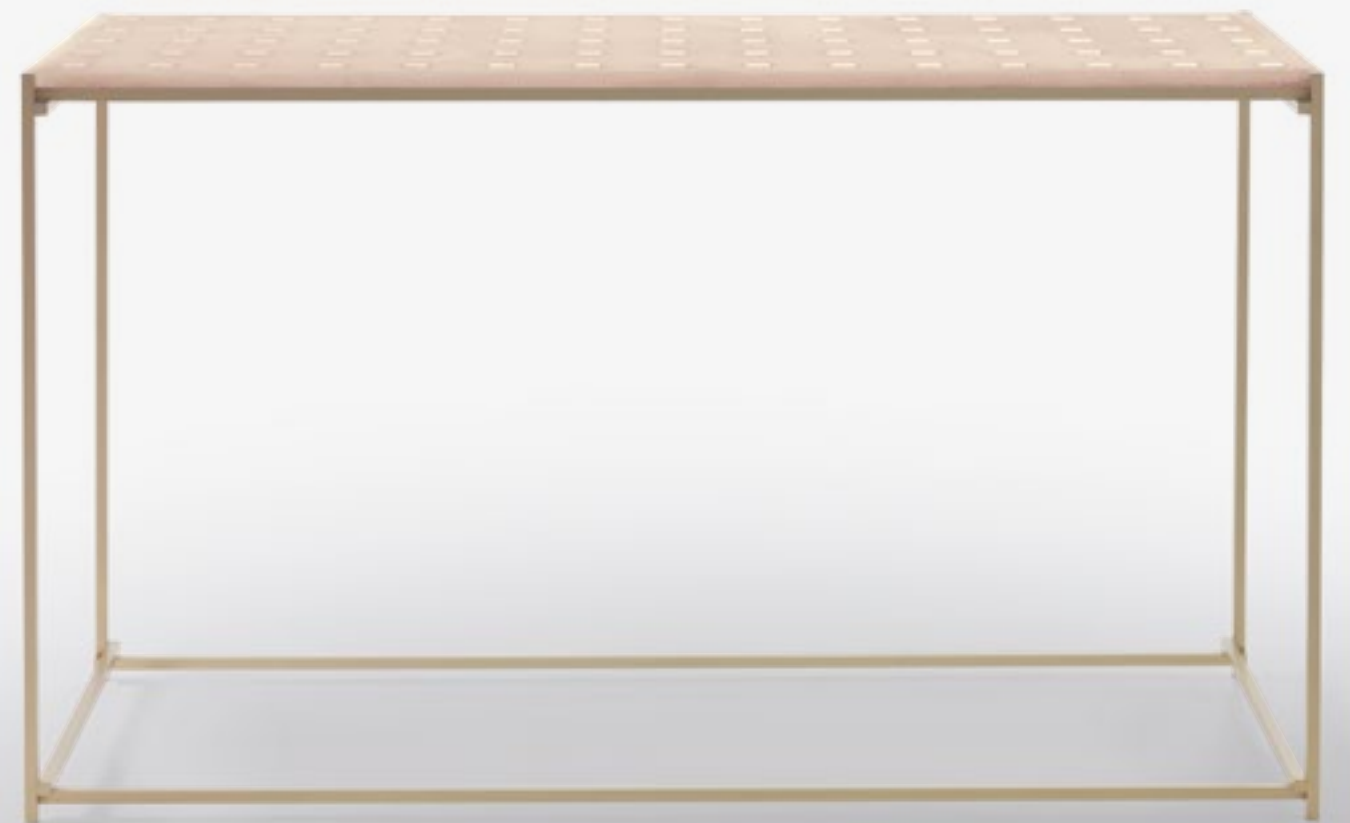

31

Pedina, Torre & Torre Maxi

Cat.
Tavolo / Table
Tavolino / Coffee table
Sistema di sedute / Seating system
Design by Enzo Berti
Year 10 - 18

Data sheet
71

Pedina è un progetto polifunzionale, nasce come sgabello in marmo e, con una variante tecnica, si evolve in un sistema di tavolini d'appoggio o in un vero e proprio tavolo, mediante la sovrapposizione di un vassoio rotondo dello stesso tipo di marmo. Dalla stessa forma sinuosa, nascono anche i tavoli Torre, disponibile in due misure di top, e Torre Maxi. In questi oggetti il marmo si esalta in tutta la sua capacità espressiva creando volumi equilibrati e raffinati giocati su linee dolci, minimal e senza spigoli. Oggetti sinuosi, scultorei, classici e all'avanguardia al tempo stesso. Frutto della ricerca innovativa sull'utilizzo e le tecniche di lavorazione del marmo, il programma Pedina è composto da oggetti di design che si inseriscono facilmente e con eleganza non ostentata in ogni ambiente.

Pedina is a multipurpose item; it is born as a marble stool but evolves, through a technical modification, into a system of support tables of two different top sizes, through the superposition of a round tray of the same type of marble. Finally, it evolves in table. From the same sinuous shape, born the tables Torre, available in two top sizes, and Torre Maxi. In those items marble is enhanced in all its expressive capacity, by creating balanced and refined volumes played on soft lines, minimal and no sharp edges. Sinuous objects, sculptures, classic and modern at the same time. As a result of innovative research techniques and marble processing, Pedina program is composed of design objects that fit easily and elegantly understated in any environment. Suitable for both home and contract.



Torre Maxi





36

Pedina & Torre



37

Torre

Tangram

Cat.
Tavolo / Table
Tavolino / Coffee table
Design by Enzo Berti
Year 16

Data sheet
70

La collezione di tavoli Tangram è caratterizzata da un piano in vetro che mette in evidenza la sua anima, la base, realizzata dall'incastro di elementi in marmo e legno massello di diversi colori e misure. Geometrie, spessori e materiali diversi, ma complementari, dalla cui compatibilità nasce una nuova unione armonica di forme, di grande impatto visivo e fortemente innovativo. Un gioco di incastri e sovrapposizioni che, alludendo al millenario gioco cinese e al famoso produttore del gioco di mattoncini danese, consente di sviluppare infinite soluzioni di arredo. Come nella filosofia di Kreoo, l'accostamento del marmo ad altri elementi materici come il legno e il vetro, esalta ancora di più l'anima segreta e sensuale di questo affascinante materiale.

Tangram collection presents elegant tables made of a glass top that highlights the structural table soul, its base, obtained by interlocking elements of stone and wooden blocks of different colors and measures. From different geometries, thicknesses and materials, among them complementary, a new harmonious shapes cluster has born, highly innovative and characterized by a great visual impact. A game of joints and overlaps, alluding to the ancient Chinese game and to the famous Danish bricks game, that both give their names to this new statement piece of furniture. As in Kreoo philosophy, the combination of marble with other materials such as wood and glass, contributes to enhance the "sensual and secret soul" of stones even more.



Tangram Maxi



40

Tangram Mono



41



42

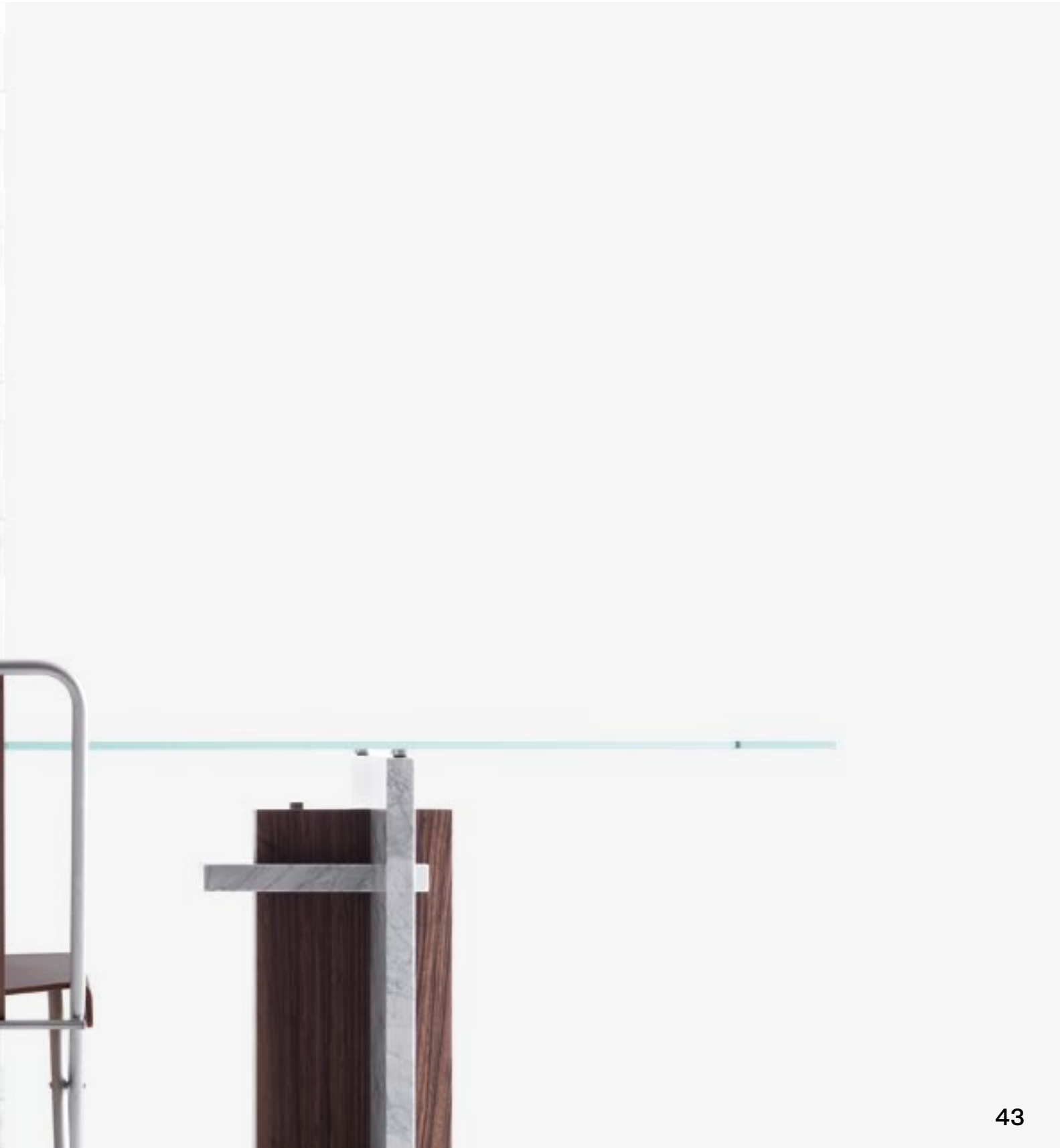

43

Tangram Maxi



Tangram Maxi





46

Tangram Mini

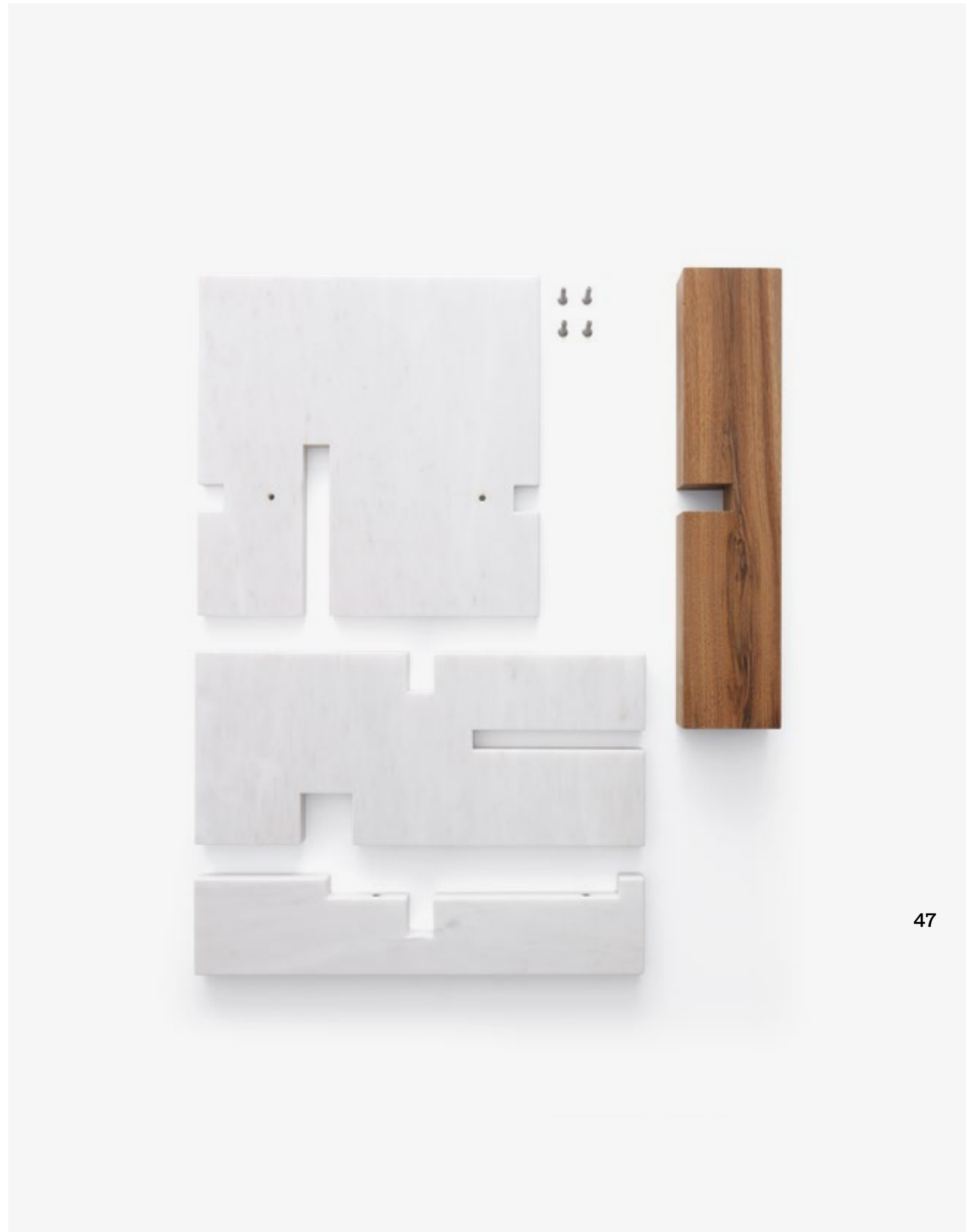

47

Oasi

Cat.
Sistema di sedute / Seating system
Design by Enzo Berti
Year 10

Data sheet
76

La vista aerea della collezione Oasi ricorda le forme tipiche degli atolli tropicali, particolari isole di natura corallina presenti nelle acque dell'Oceano Indiano e Pacifico. Proposta anche singolarmente ma ideale in gruppo poiché accostate queste sedute costituiscono un vero e proprio sistema. Le linee fluide che ne disegnano i contorni ricordano forme organiche, perfette nella loro naturale irregolarità. La materia millenaria plasmata nella sua autenticità conferisce al volume una dignità scultorea che riempie silenziosamente gli spazi creando ricercate oasi di conversazione o di semplice attesa.

The aerial view of Oasi collection recalls typical forms of tropical atolls, the particular coral islands of the Indian and Pacific Oceans. It is available also individually, but at best in-group because they constitute a proper seating system. The flowing lines of the contours recalls organic shapes, those are perfect in their natural irregularity. The substance formed thousands of years ago and shaped in its authenticity gives volumes to conversation islands and waiting rooms.



Oasi n°3



I.



III.

II.

Pavé

Cat.
Sistema di sedute / Seating system
Tavolino / Coffee table
Design by Enzo Berti
Year 10

Data sheet
75

La collezione Pavé di Kreoo, disegnata da Enzo Berti, trae origine dall'elaborazione scultorea che il fluire dell'acqua produce sulle pietre del greto scavandole e levigandole fino a creare piccoli esempi di opere perfette in natura. La collezione è composta dalle sedute Pavé Stone, ottenute sovrapponendo una base in marmo ovale e una di legno, e dalle due varianti Stream & River, dalla panca Pavé Log, un'unica asse in legno sovrapposta alle basi in marmo, e dal tavolino d'appoggio Pavé Drink, nel quale dalla base in marmo Pavé Stone parte lo stelo in metallo che sostiene il piano circolare in legno. Pavé Collection: singole o multiple isole conviviali, oggetti di design che si ricongiungono alla natura posizionati all'interno, e si fondono con essa all'esterno.

The Pavé collection by Kreoo, designed by Enzo Berti, is inspired by the effect of natural river water gliding over the stones of the river bed: water flows, smoothes and polishes, forming nature's great artwork. The collection is composed by Pavé Stone seats, realized through the overlap of an oval marble base and a wood seat, with its two variants Stream & River, by the bench Pavé Log, a unique wooden board that overlaps the original marble bases, and by the Pavé Drink table, characterized by free combinations of the classic marble base with a metal stem that is the support for the round wooden top. Pavé Collection: single or multiple convivial islands, design objects that recalls the nature indoors, and merge with it outdoors.



Pavé Stones & Drink





56

Pavé Log & Drink



57



Shiro

Cat.
 Libreria / Bookcase
 Design by Enzo Berti
 Year 12

Data sheet
 77

Shiro è un versatile sistema modulare realizzato in marmo/legno che per misure, forme e interpretazioni si presta particolarmente all'impiego in ambienti Contract. Si tratta di un'architettura modulare basata sull'accostamento fortemente materico di marmo e legno, un gioco statico basato sulla forza di gravità che permette ad ogni modulo di essere assemblato semplicemente attraverso due sole spine per diventare, a piacere, libreria o mobile di contenimento senza ante. Una variazione armonica di piani orizzontali e verticali capace di interpretare le diverse esigenze abitative e professionali: è questa la plurima anima di Shiro che, nella versione libreria, si esprime anche nella duplice proposta in appoggio alla parete o in veste bifacciale.

Shiro is a versatile modular system realized in wood and marble, and thanks to its shape and possible interpretations it is particularly suitable for Contract use. Its concept is based on the combination of wood and marble, a static gravity game that allows to each module to be installed only with two plugs; and it can be a bookcase or furniture with no doors. The harmonic variation of horizontal and vertical plans is able to interpret various living and professional needs: and this is the soul of Shiro. The bookshelf is available both in a single version, leaning against a wall, or a double, bifacial one.





Vis à Vis

Cat.
Chaise longue
Design by Enzo Berti
Year 12

Data sheet
78

Vis à Vis è una raffinata e rilassante chaise longue. È disponibile nella versione singola o doppia, quest'ultima consente agli utenti anche un piacevole approccio "vis à vis" da cui prende il nome. Il corpo centrale è proposto in diverse tipologie di materiale lapideo per conferire note di colore diverse secondo gusti ed esigenze cromatiche. Evocazione di un tempo lento per un benessere fisico e mentale, Vis à Vis si integra perfettamente nell'ampio progetto bagno di Kreoo, modulare e di grande ampiezza stilistica, che re-interpreta gli spazi dando loro un'impronta di forte matericità e sensuale bellezza.

Vis à Vis is a refined and relaxing chaise longue that challenges suspension. Is available both in the single and double version, which gives a pleasant vis à vis approach. The central element is proposed in various marbles in relation to aesthetic tastes and color needs. It is a slow time evocation for a physical and mental comfort. Vis à Vis perfectly integrates in the wide Kreoo bathroom project, which is modular and stylish. It re-interprets spaces giving a strong materic and sensual beauty.



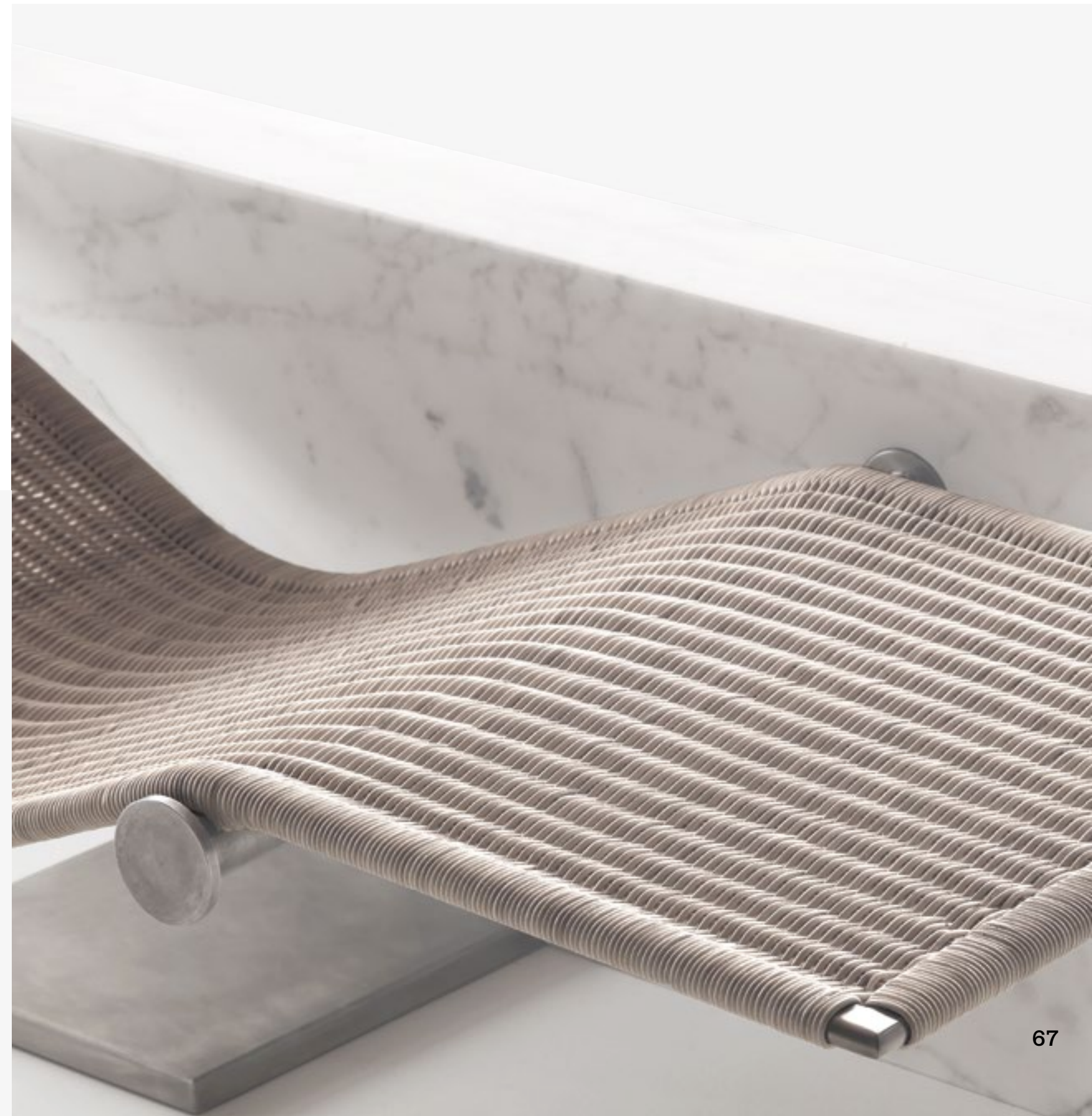

Tavolo
/Table

Arcaico

Design by Enzo Berti
pag. 2 + 9

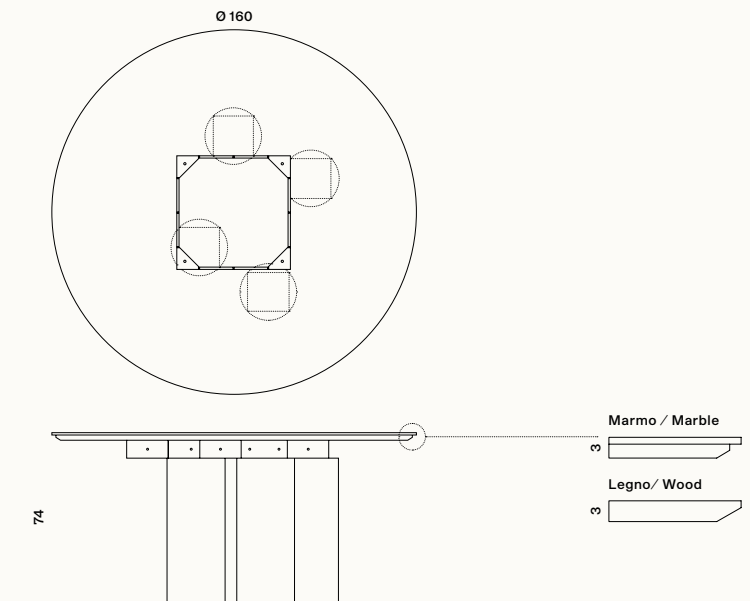
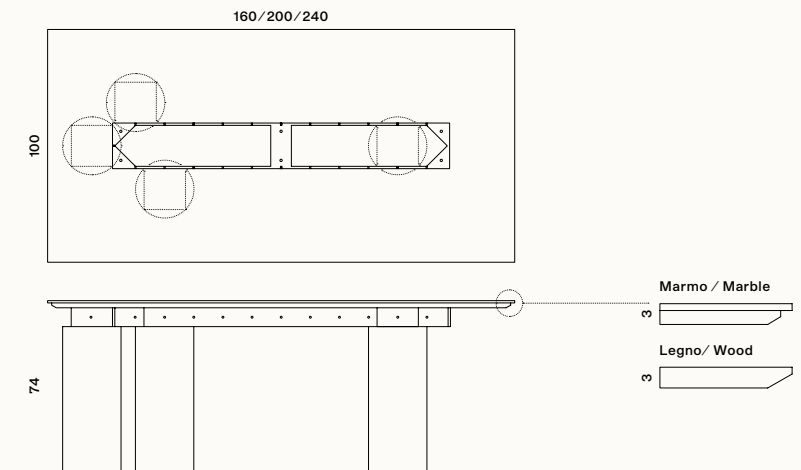

Top

Cilindri basi / Cylinder bases



Tangram Collection

Design by Enzo Berti
pag. 38 - 47

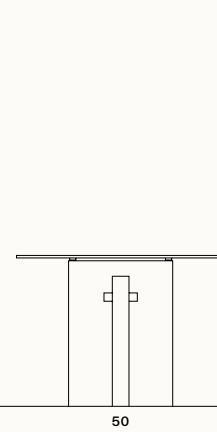
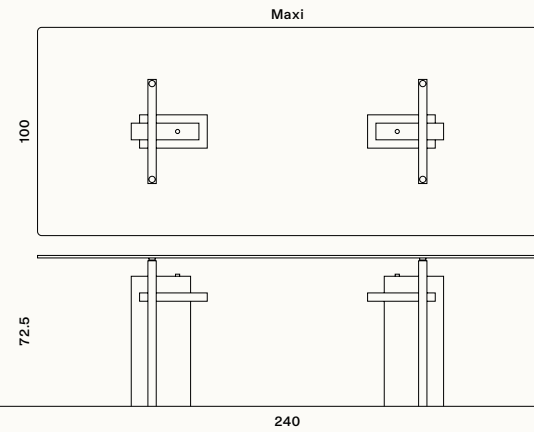
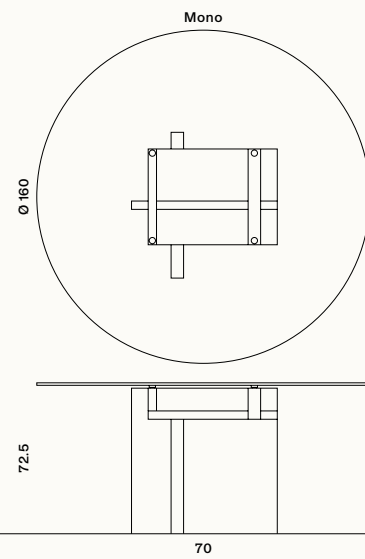
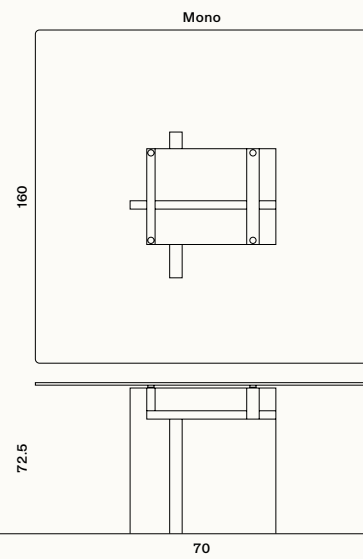
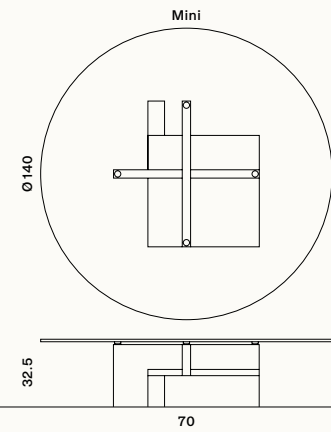
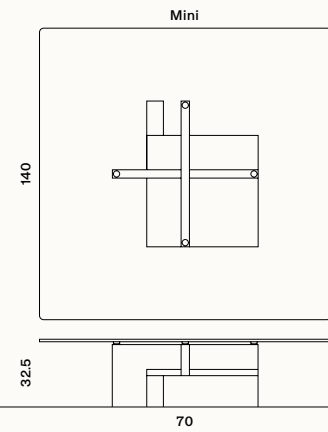

Struttura / Structure

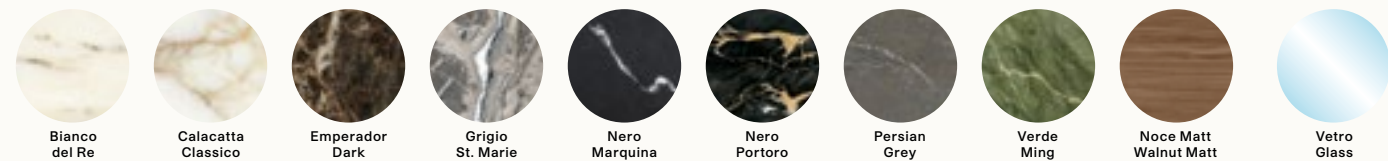

Top

Torre & Torre Maxi

Design by Enzo Berti
pag. 32 - 37

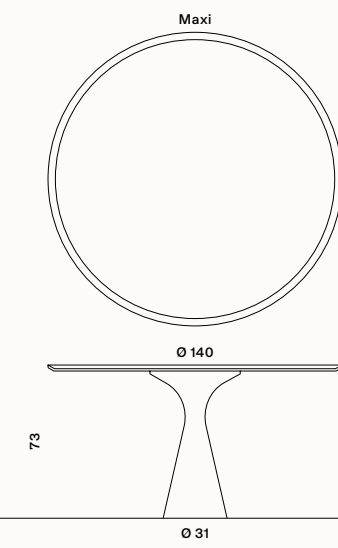
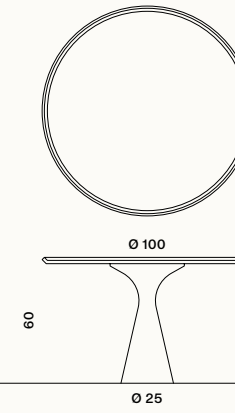
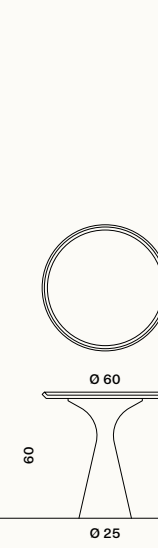

Marmo / Marble

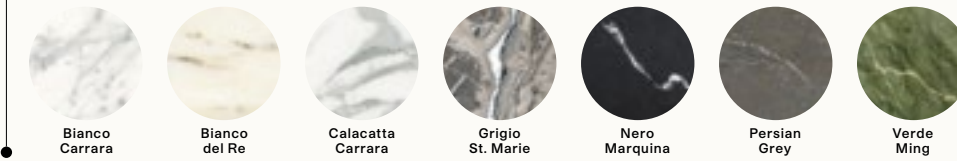

Pedina

Design by Enzo Berti
pag. 36

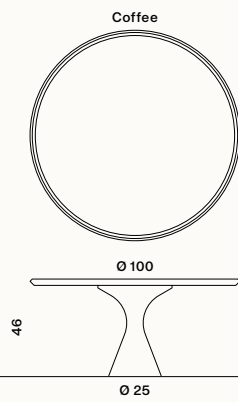
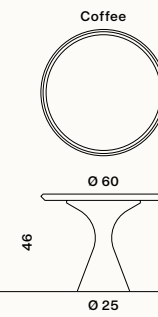

Sistema di sedute
/ Seating system

Tavolino
/ Coffee table

Marmo / Marble

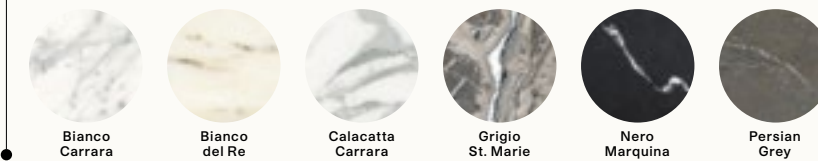

Tavolino
/ Coffee table

Jackie

Design by Sebastiano Zilio
pag. 16 › 19

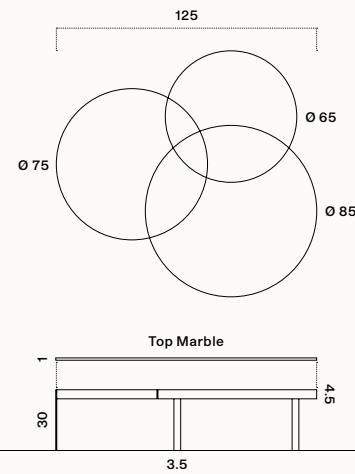

Marmo / Marble

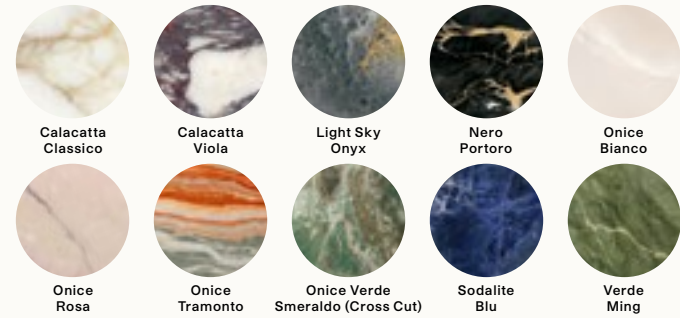

Metallo / Metal

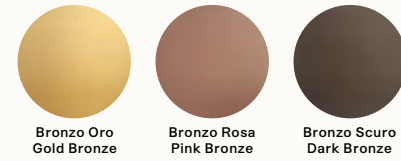

John

Design by Sebastiano Zilio
pag. 20 › 21

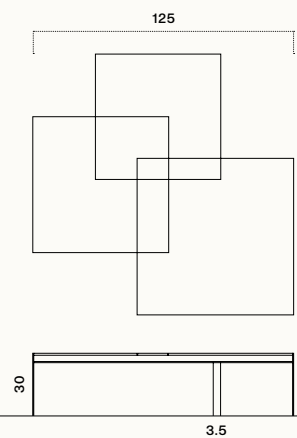

Marmo / Marble

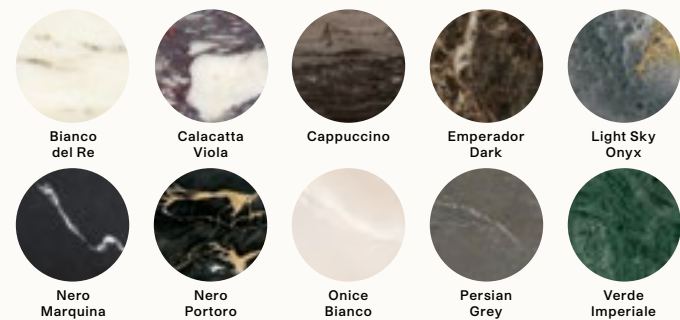

Metallo / Metal



Moon

Design by Enzo Berti
pag. 22 › 25

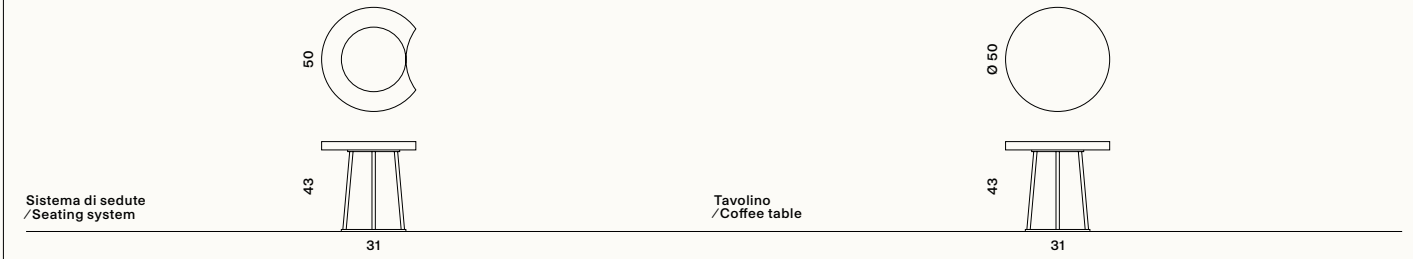

Marmo / Marble

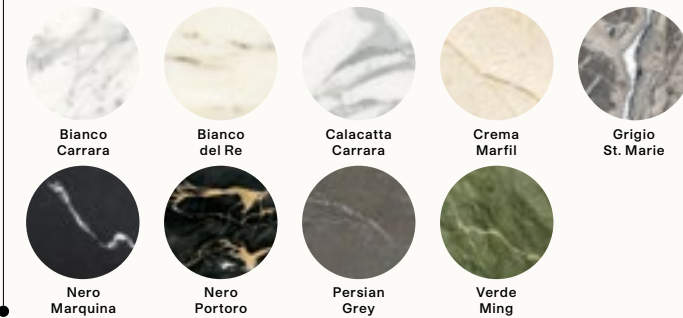

Legno / Wood

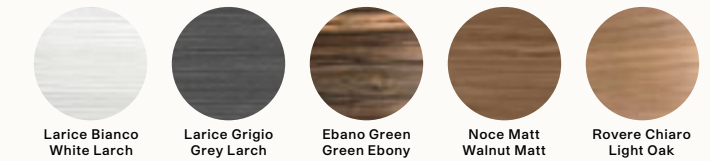

Dora

Design by Enzo Berti
pag. 10 › 15

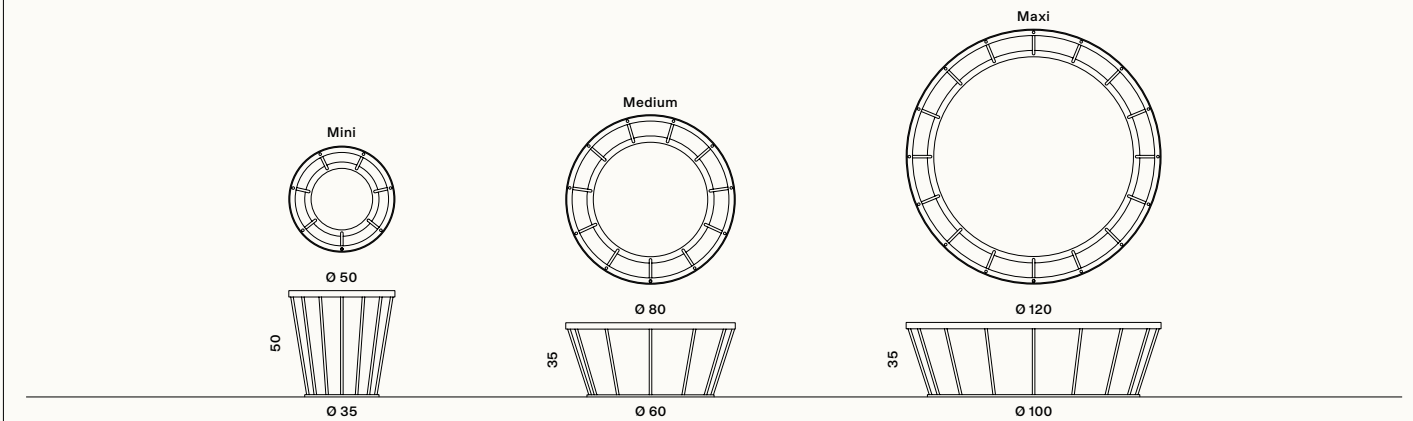

Marmo / Marble

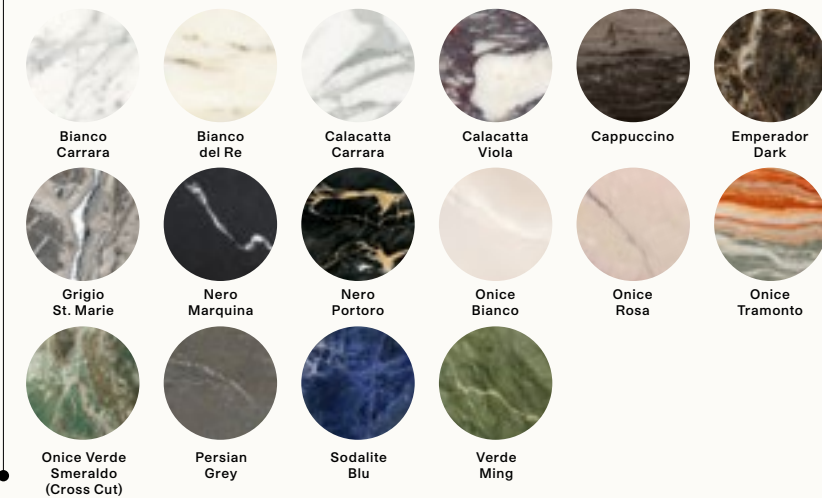

Metallo / Metal



Tavolo e Tavolino
/ Table & Coffee table

Nodo

Design by Enzo Berti
pag. 26 > 31

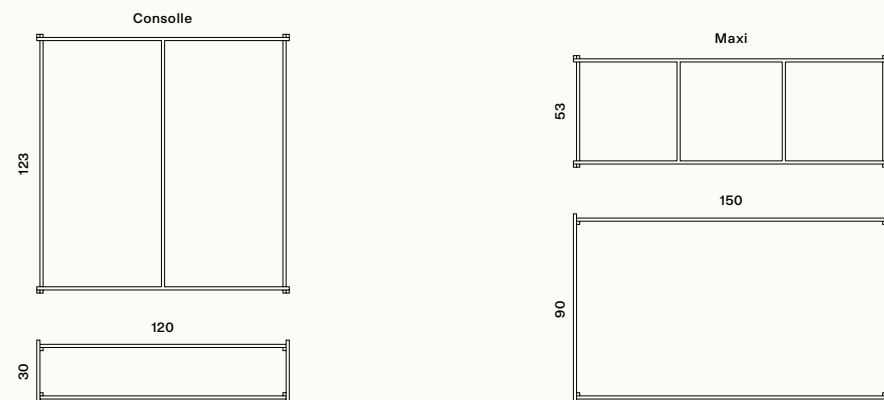
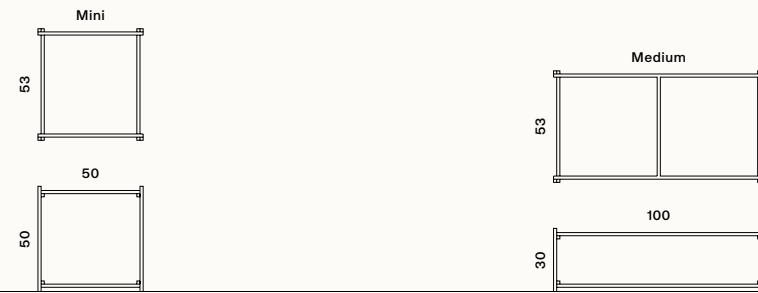

Marmo / Marble

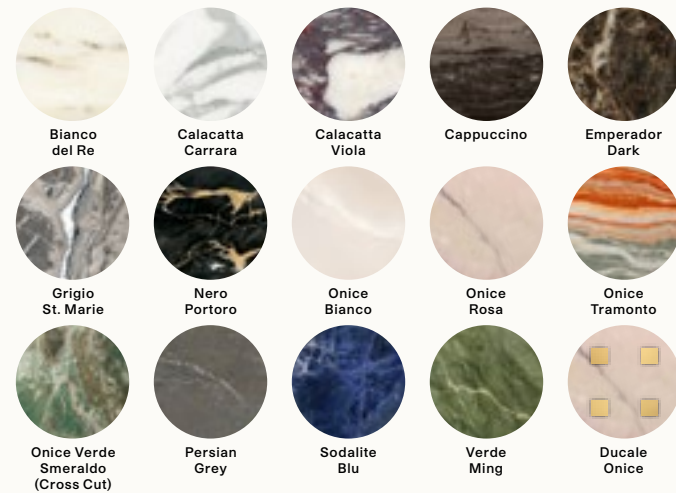

Metallo / Metal



Sistema di sedute
/ Seating system

Pavé Stones

Design by Enzo Berti
pag. 52 > 59

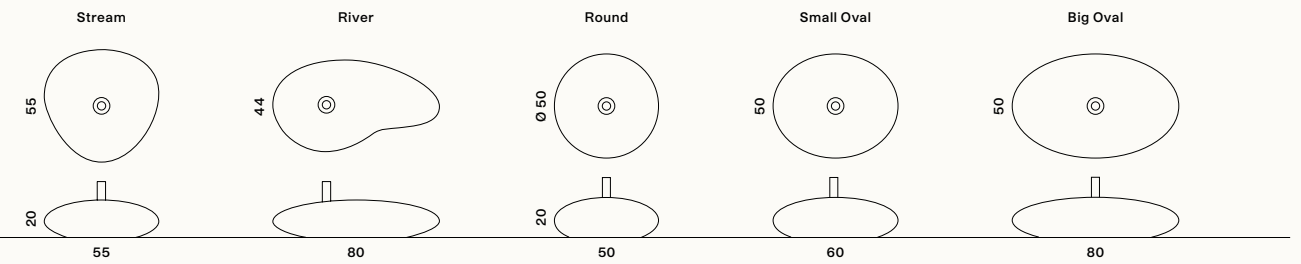

Marmo / Marble

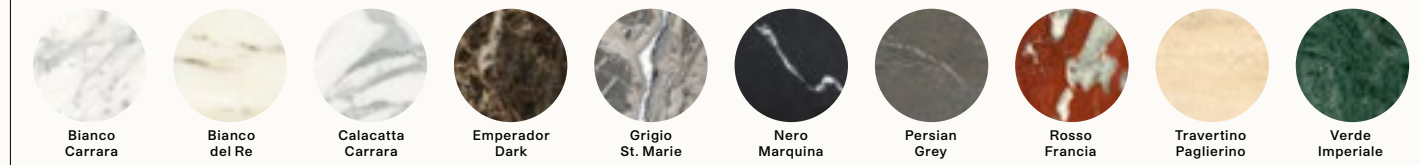

Round Seating, Small Oval Seating, Big Oval Seating

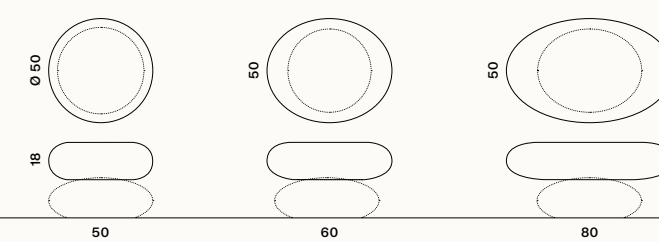

Seduta / Seat



Sistema di sedute
/ Seating system

Pavé Long & Drink

Design by Enzo Berti
pag. 52 > 59

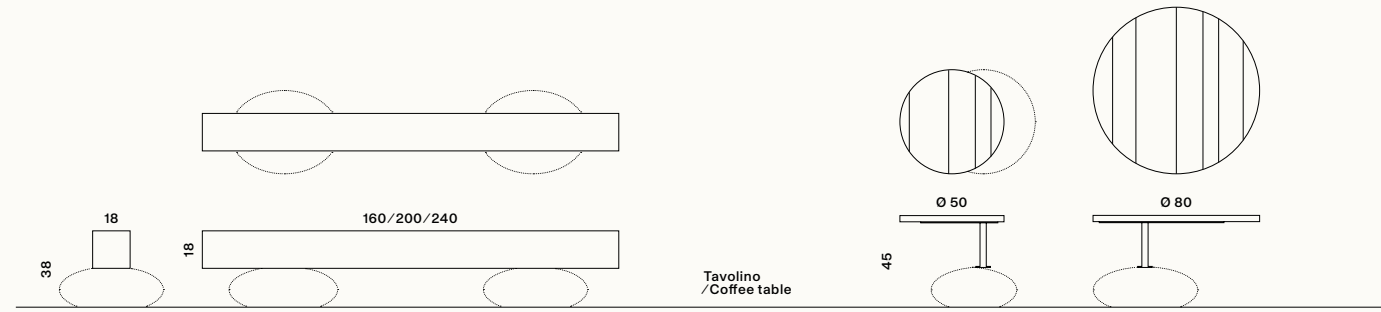

Legno / Wood

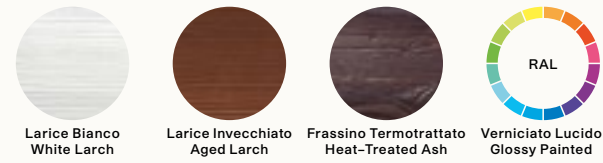

Oasi

Design by Enzo Berti
pag. 48 > 51

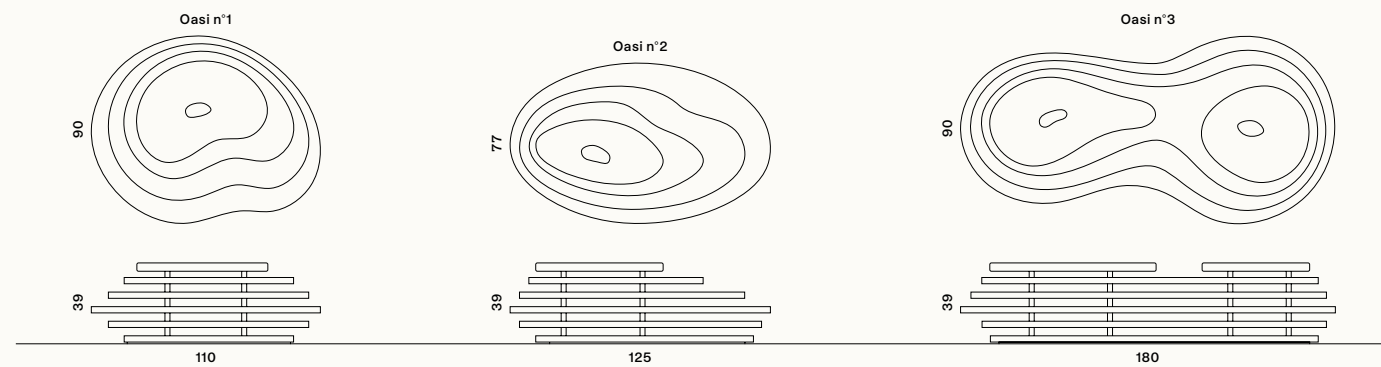

Base in Marmo / Marble base

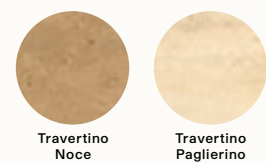

Seduta in Legno / Wood seat



Libreria
/ Bookcase

Shiro

Design by Enzo Berti
pag. 60 > 63

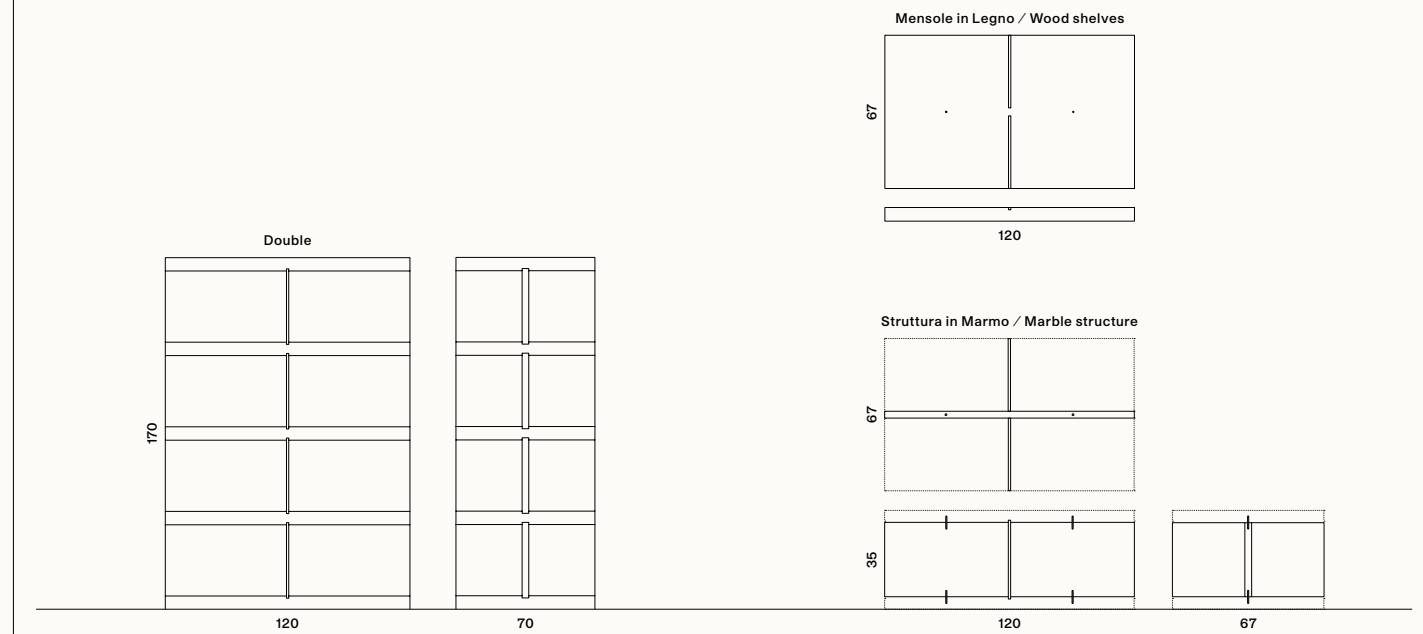
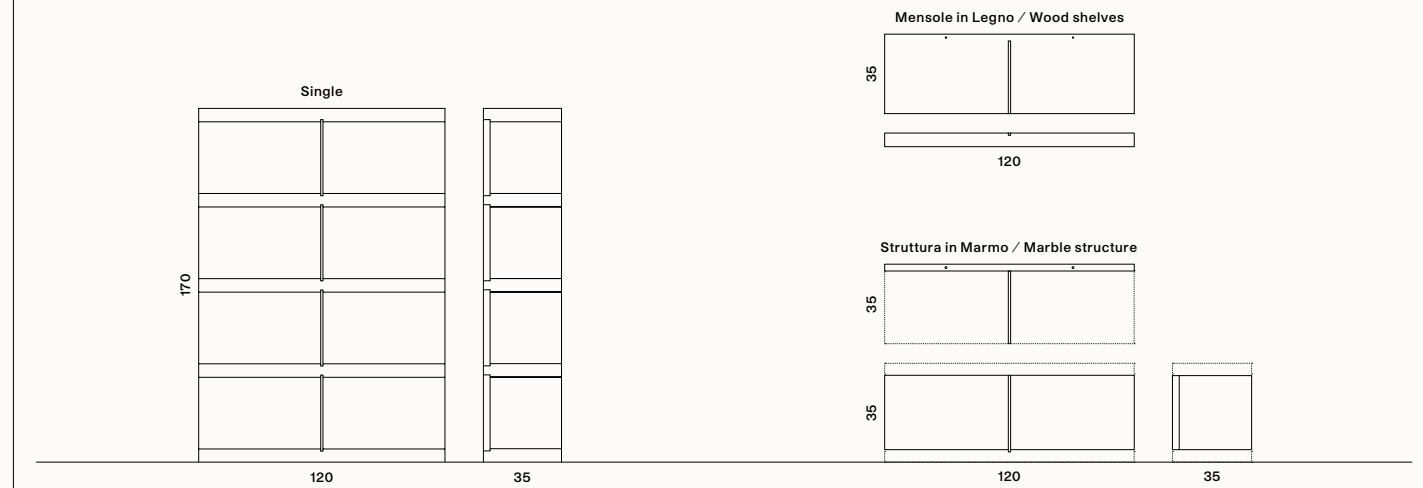

Marmo / Marble



Mensole / Shelves

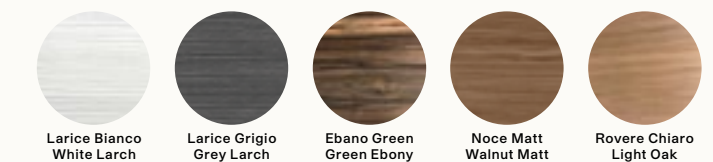

Chaise longue

Vis à Vis

Design by Enzo Berti
pag. 64 - 67

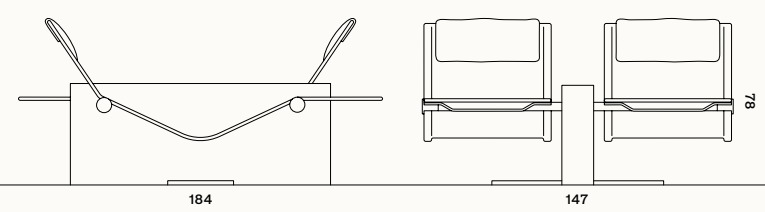
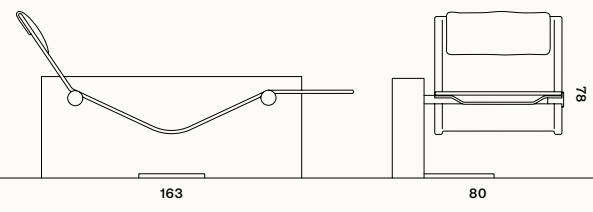

Marmo / Marble



Bianco Carrara

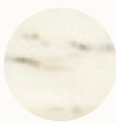

Bianco del Re



Calacatta Classico

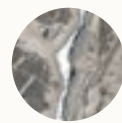

Grigio St. Marie

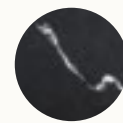

Nero Marquina



Midollino Naturale
Natural Wicker

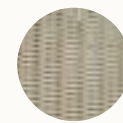

Midollino Tecnico
Technical Wicker
(Lloyd Loom)

Cuscino / Pillow



Lino Naturale
Natural Linen

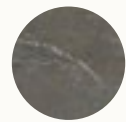

Persian Grey

Per sua natura ogni marmo o pietra presenta colori, venature e fessure uniche, che attestano ed esaltano le qualità di naturalezza e unicità del prodotto. Kreoo si riserva la facoltà di apportare ai propri modelli qualsiasi modifica tecnica, nelle dimensioni e nei colori, ritenuta necessaria, nonché la facoltà di sospendere la produzione in qualunque momento senza preavviso, rinunziata fin d'ora da parte del committente ogni conseguente richiesta risarcitoria. Si declina ogni responsabilità relativa ad eventuali inesattezze contenute in questo catalogo, se dovute ad errori di stampa o trascrizioni.

Each marble or limestone can present different colors and veins that exalt and confirm its naturalness and uniqueness. Note: Kreoo reserves the right to make any and all necessary technical, colour or size modifications to the furniture in order to enhance its use and esthetic value, and may suspend the production cycle at any moment without notice. Such instances may not be subject to claim by the client. We decline all responsibilities for any possible uncertainties due to misprints in this catalogue.

Kreoo
Via Duca d'Aosta, n°17/e
36072, Chiampo
Vicenza - Italy
P. iva 02799900242

Ph (39) 0444 68 8311
Fax (39) 0444 68 8380
info@kreoo.com
kreoo.com

Art direction, concept
and graphic design
→ Studio Malisan

Photography
→ Tobia Berti

→ Studio Eye
(pag. 27)

Image
→ Nudesignstudio
(pag. 3, 21)

Colour separation
and printing
→ Grafiche GFP
2018

kreoo

Via Duca d'Aosta, n°17 / e
36072, Chiampo
Vicenza - Italy
P. iva 02799900242

Ph (39) 0444 68 8311
Fax (39) 0444 68 8380
info@kreoo.com
kreoo.com