



e r b a





**NOT JUST  
A TREND  
BUT A  
TRUE  
STYLE**

NIRVANA	06
ABBEY ROAD	12
EDIZIONE	16
DYLAN	22
CANZONE	30
ICONA	34
VIAGGIO	38
PROFILE	44
PENSIERO	46
BE POP	50
RED BARON	56
ALBA CHIARA	62
AUTOGRAFO	68
VICEVERSA	76
ATOLLO	80
BALLA CON ME	86
OPALE	90
NOTTURNO	94
LEGENDA	98
CARTA BIANCA	100
FIORE	108
DISCO	114
MACCHIA	116
ARTE	118
ROCK COCO	122
NORD	124
LAMP AND COFFEE TABLE	126
TI AMO	128
RIFLESSO	130
PASO DOBLE	132
LEGGERO	134
ELEGANZA	138
I LOVE YOU	144
SENSAZIONE	150

# NIRVANA

design Giorgio Soressi







# ABBEY ROAD







16

# EDIZIONE

design Giorgio Soressi







# DYLAN

design Giorgio Soressi











# CANZONE





# ICONA



design Giorgio Soresi

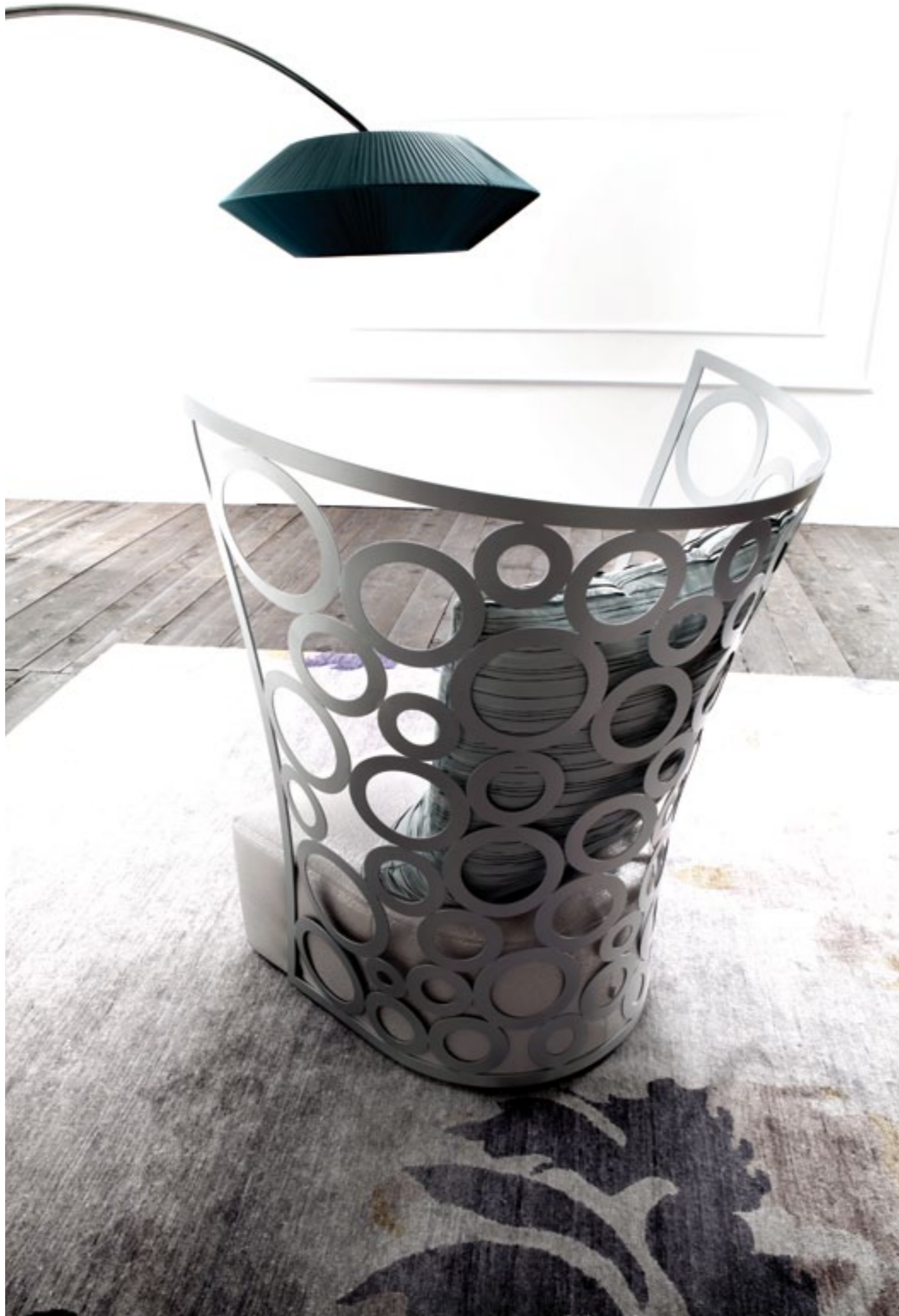

# VIAGGIO







# PROFILE



design Giorgio Soresi



# PENSIERO





# BE POP

design Giorgio Soresi







# RED BARON

design Giorgio Soresi









# ALBACHIARA







68

# AUTOGRAFO

design Giorgio Soressi









# VICEVERSA







80

# ATOLLO

design Giorgio Soressi







**BALLA CON ME**



design Giorgio Soressi



90

# OPALE

design Giorgio Soressi







# NOTTURNO





# LEGENDA

design Giorgio Soressi



# CARTABIANCA



design Giorgio Soresi







**LAMPADE / LAMPS**

# FIORE



108

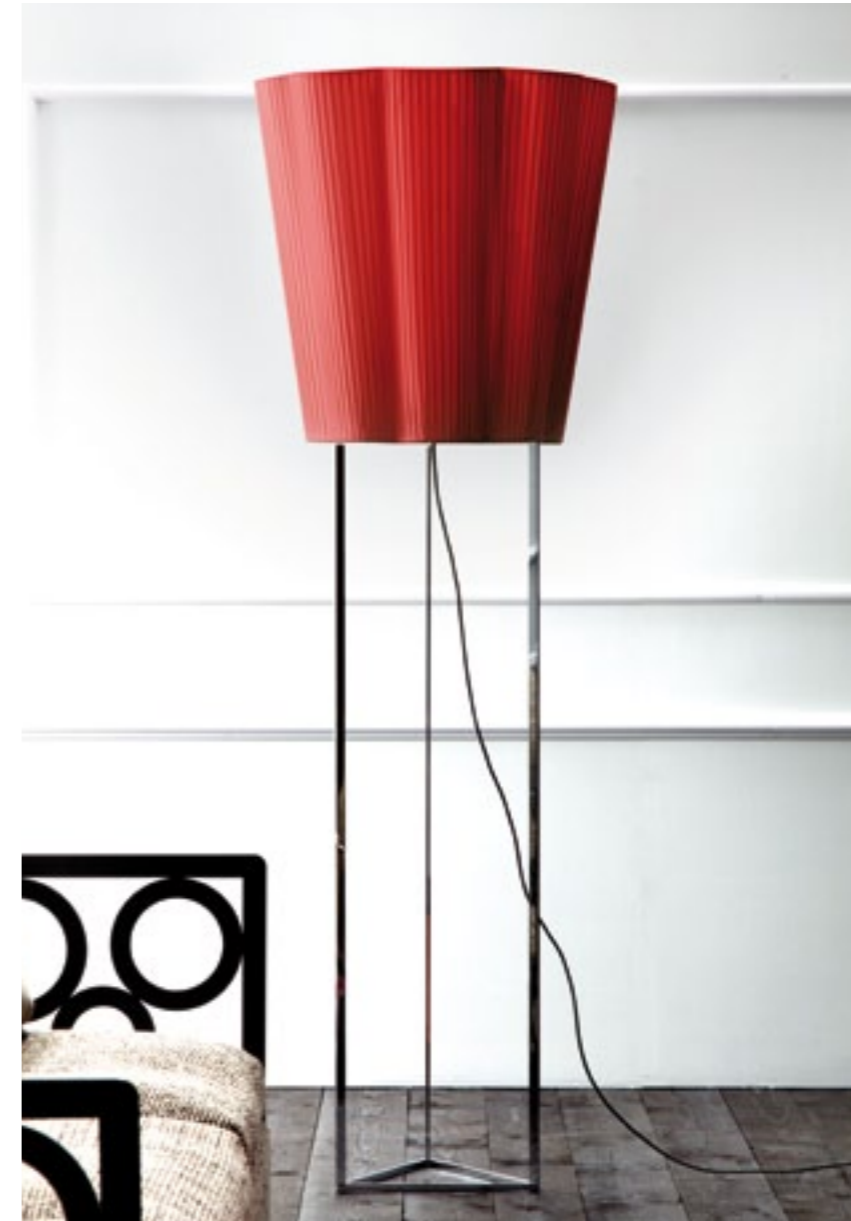

109







# DISCO

114



115

# MACCHIA





# LAMP AND COFFEE TABLES



# ROCK COCO



design Giorgio Soressi



# NORD



124

design Giorgio Soressi



125



# LAMP AND COFFEE TABLE



126



127

# TI AMO



# RIFLESSO



130

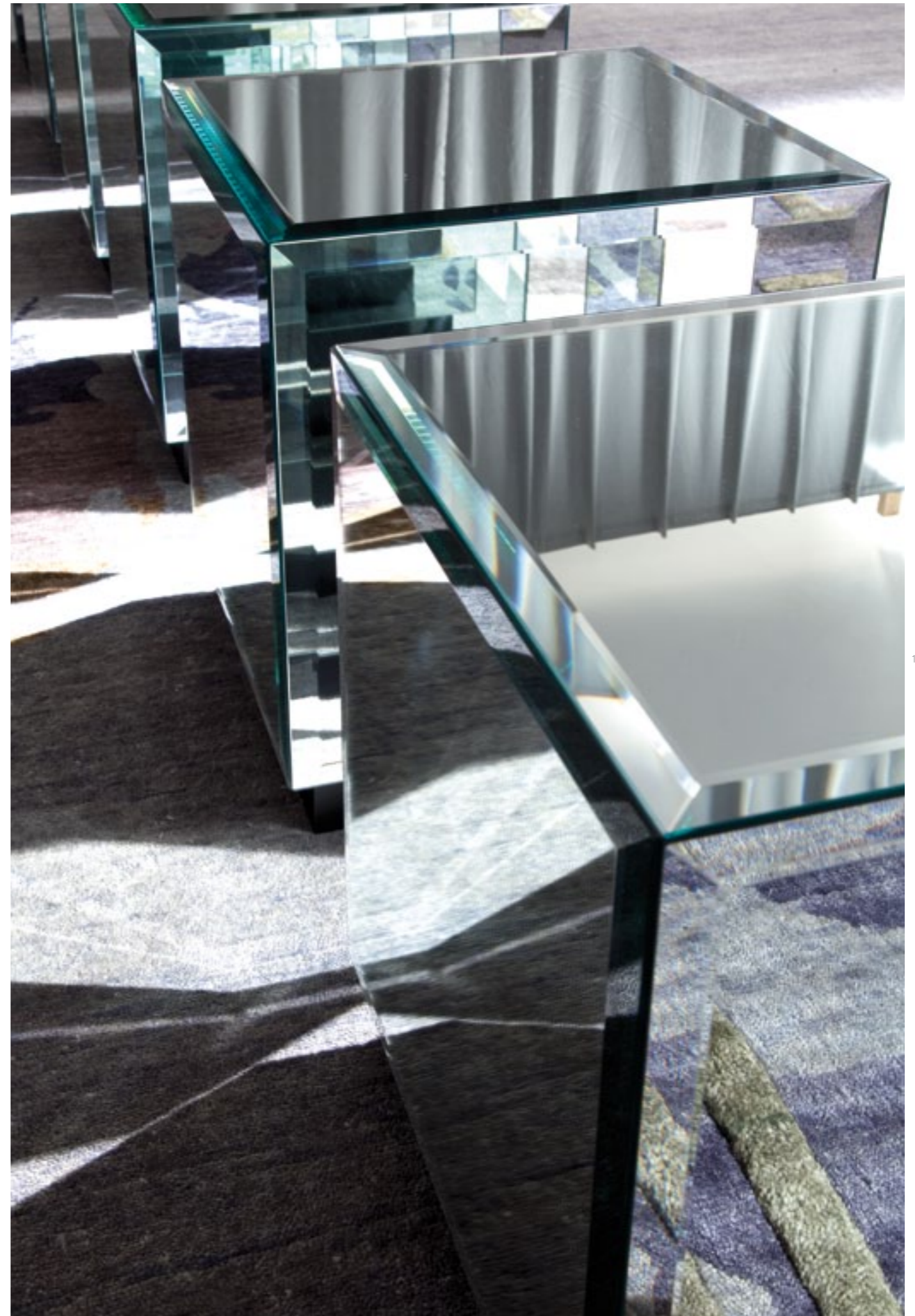

131

# PASO DOBLE



132

design Giorgio Soressi



133

# LEGGERO - PASO DOBLE



134



135



**SPECCHIO/MIRROR**

# ELEGANZA

138

design Giorgio Soressi



139





A close-up photograph of a carpet featuring a repeating geometric pattern. The pattern consists of thick, green, U-shaped or rectangular outlines set against a textured, light purple background. The carpet fibers are visible, giving it a plush appearance. The lighting is soft, highlighting the texture and the vibrant colors of the pattern.

# TAPPETI/CARPETS

I LOVE YOU







# SENSAZIONE

150



151



# NIRVANA

PAG. 06

## POLTRONA/ARMCHAIR

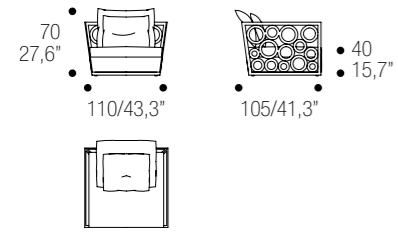

## ELEMENTI CENTRALI/CENTRAL UNITS

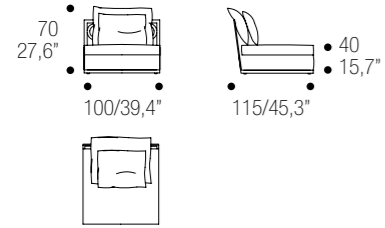

## TERMINALE/TERMINAL SX-DX

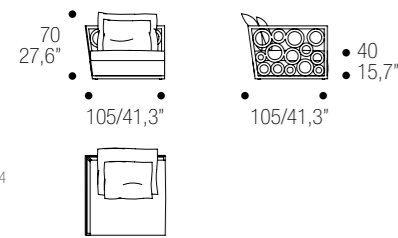

## DIVANI/SOFAS

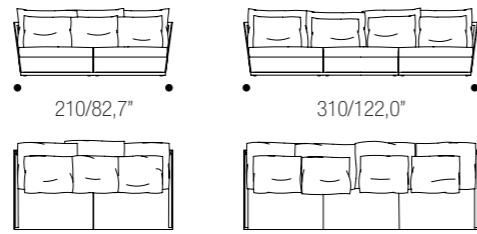

## COMPOSIZIONI/SECTIONALS

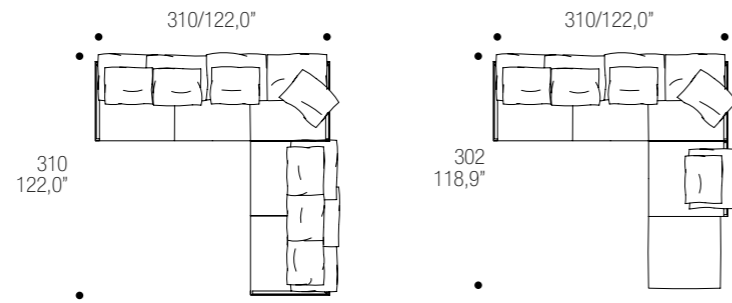

## POUF

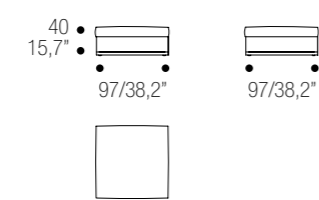

## CUSCINO/PILLOW

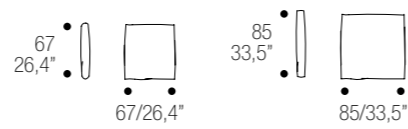

# EDIZIONE

PAG. 16

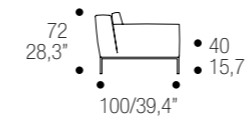

## DIVANI/SOFAS

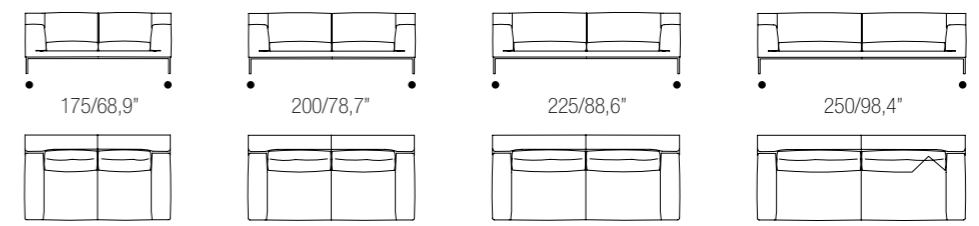

## TERMINALI/TERMINALS SX-DX

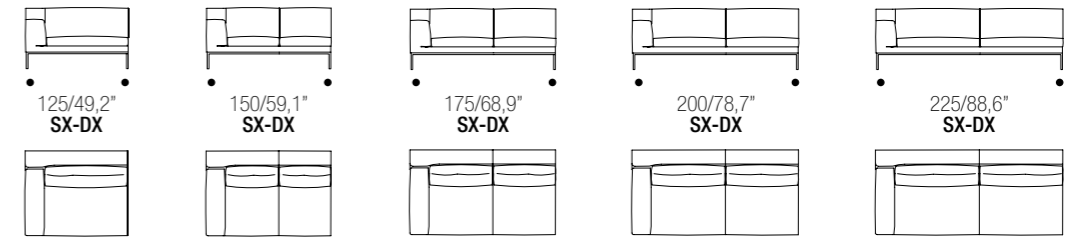

## DORMEOUSE SX-DX

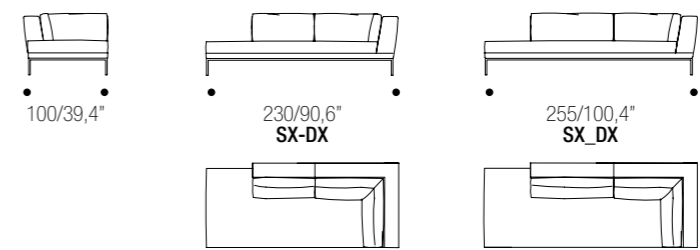

## CHAISE LONGUE SX-DX

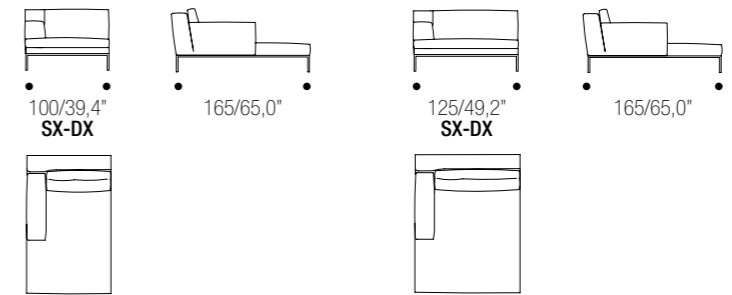

## POUFF

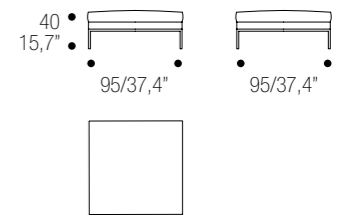

## COMPOSIZIONI/SECTIONALS

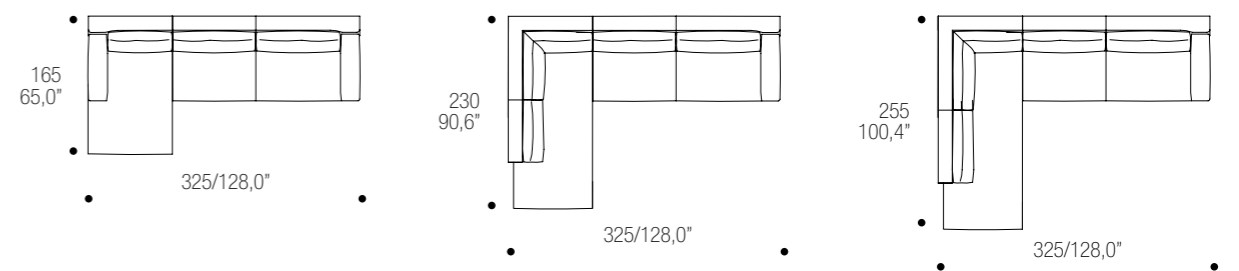

# ABBEY ROAD

PAG. 12

## POLTRONA/ARMCHAIR

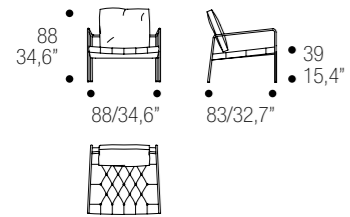

# DYLAN

PAG. 22

## DIVANI/SOFAS

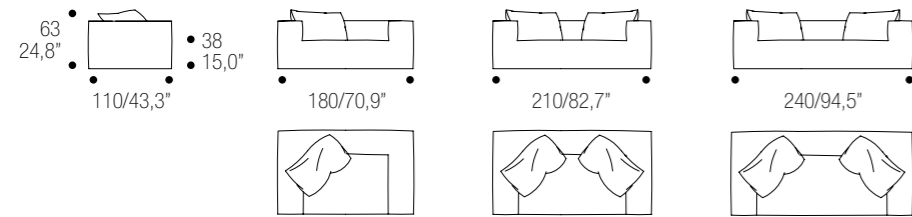

## TERMINALI/TERMINALS SX-DX

Elementi terminali con 1 bracciolo SG 0 DG

End units with 1 arm left or right

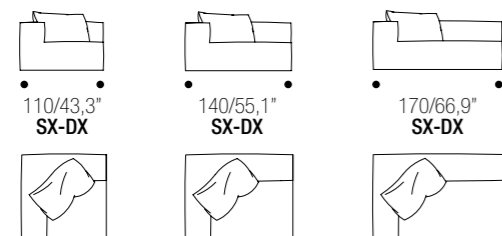

## ELEMENTI CENTRALI/CENTRAL UNITS

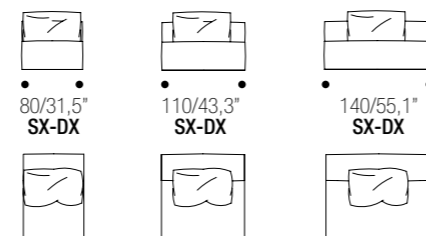

## ANGOLO/CORNER SX-DX

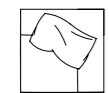
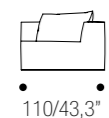
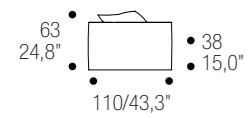

## CHAISE LONGUE SX-DX

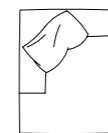
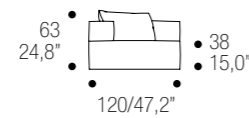

## CUSCINO/PILLOW

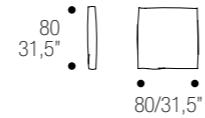

## POUFF

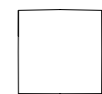
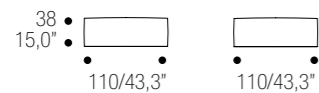

## COMPOSIZIONI/SECTIONALS

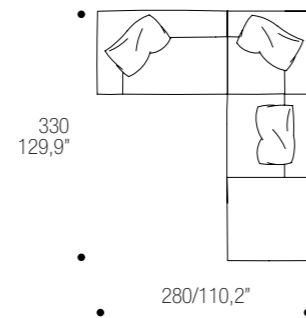
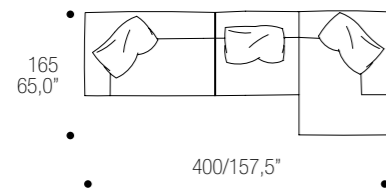

# CANZONE

PAG. 30

## POLTRONA/ARMCHAIR

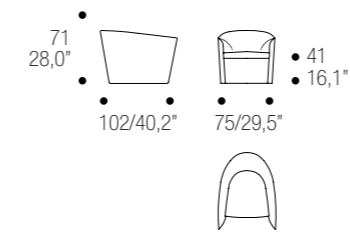

# ICONA

PAG. 34

## POLTRONA/ARMCHAIR

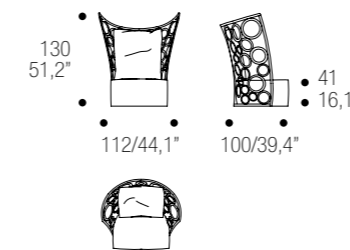

# VIAGGIO

PAG. 38

## DIVANI/SOFAS

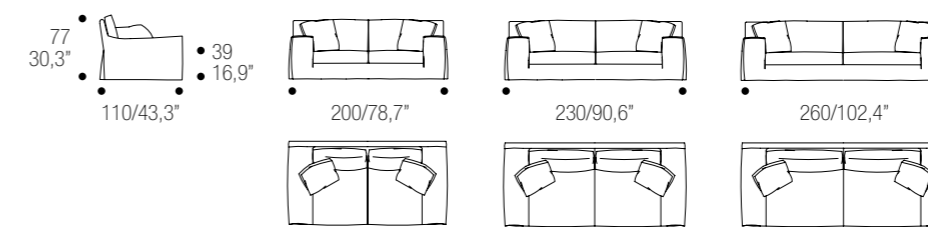

## TERMINALI/TERMINALS SX-DX

Elementi terminali con 1 bracciolo SG 0 DG

End units with 1 arm left or right

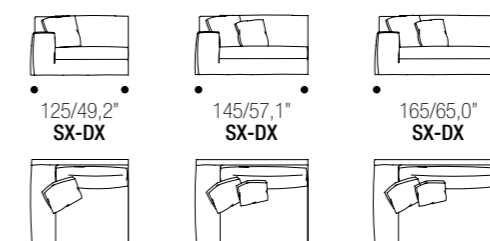

## ELEMENTI CENTRALI/CENTRAL UNITS

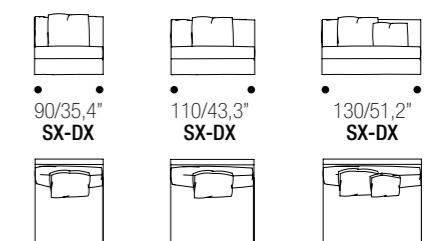

## ANGOLO/CORNER SX-DX

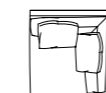
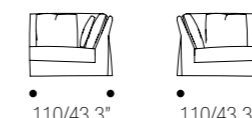

## CHAISE LONGUE SX-DX

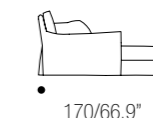
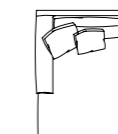



## VIAGGIO

PAG. 38

### CUSCINO/PILLOW

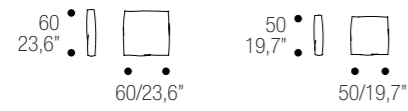

### POUF

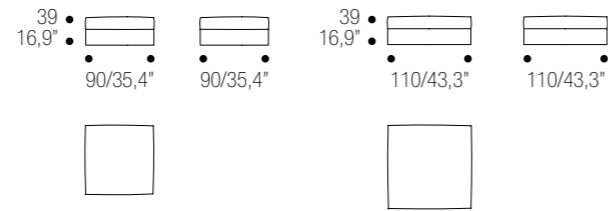

### COMPOSIZIONI/SECTIONALS

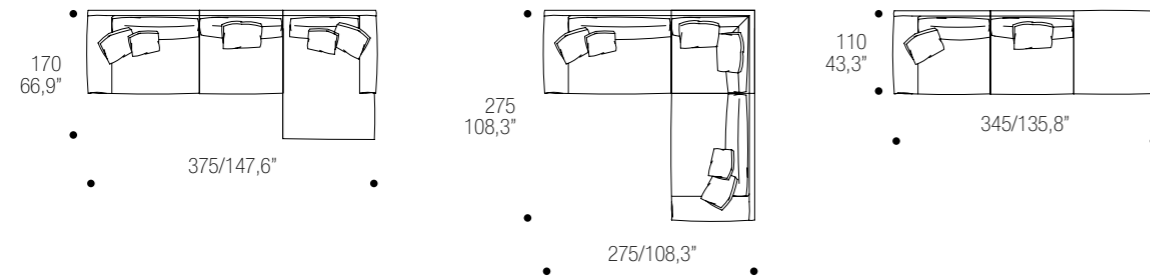

## PROFILE

PAG. 44

### POLTRONA/ARMCHAIR

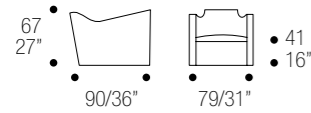

158

## PENSIERO

PAG. 46

### POLTRONA/ARMCHAIR

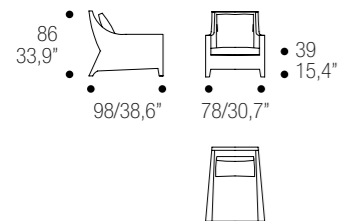

## BE POP

PAG. 50

### CHAISE LONGUE

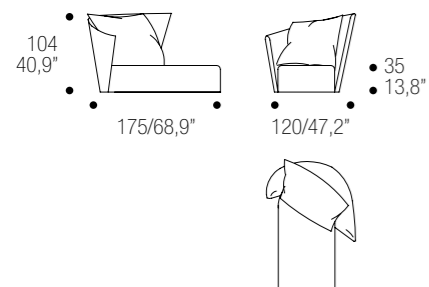

## BE POP capitonné

PAG. 50

### CHAISE LONGUE

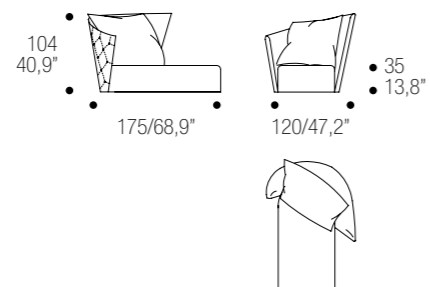

## RED BARON

PAG. 56

### POLTRONA/ARMCHAIR



## ALBACHIARA

PAG. 62

### DIVANI/SOFAS

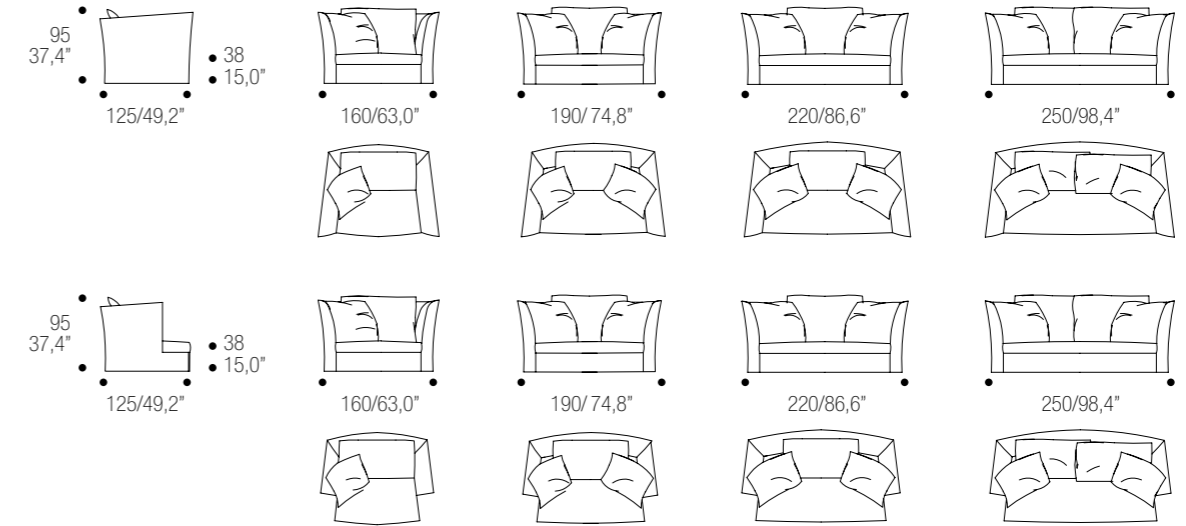

### ANGOLO/CORNER SX-DX

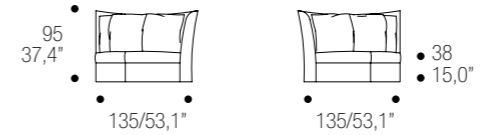

### CUSCINO/PILLOW

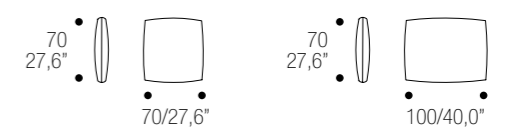

### TERMINALI/TERMINALS SX-DX

Elementi terminali con 1 bracciolo lungo SG O DG

End units with 1 long arm left or right

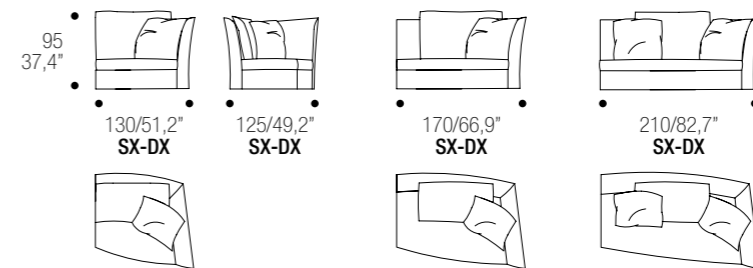

Elementi terminali con 1 bracciolo corto SG O DG

End units with 1 short arm left or right

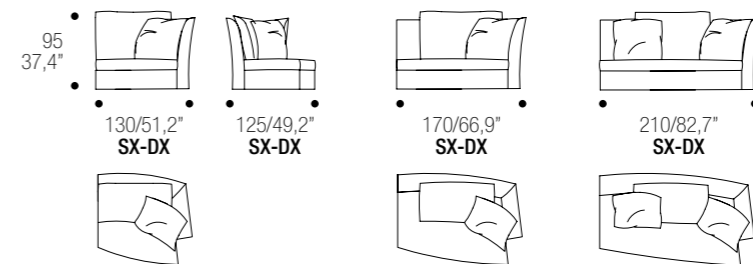

159

# ALBACHIARA

PAG. 62

## COMPOSIZIONI/SECTIONALS

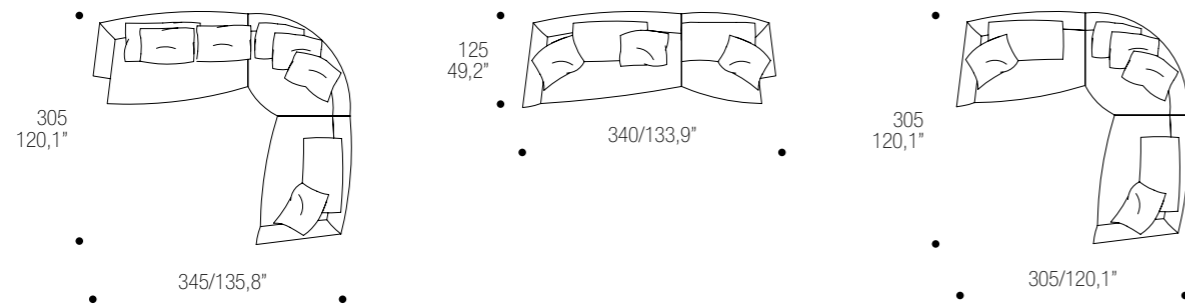

# AUTOGRAFO capitonné

PAG. 68

## POLTRONA/ARMCHAIR

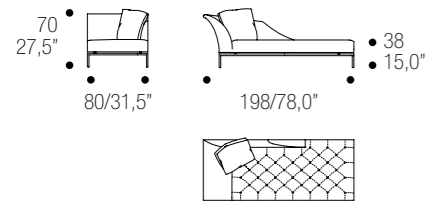

# VICEVERSA

PAG. 76

## DIVANO/SOFA

Divano con 1 bracciolo  
SG O DG  
Sofa with 1 straight  
left or right

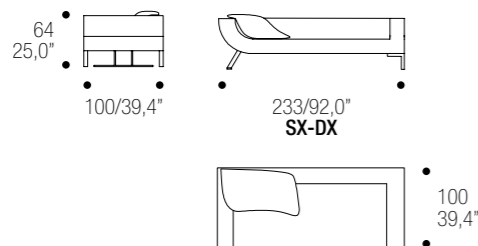

## CHAISE LONGUE

Chaise longue  
SG O DG  
Chaise longue  
left or right

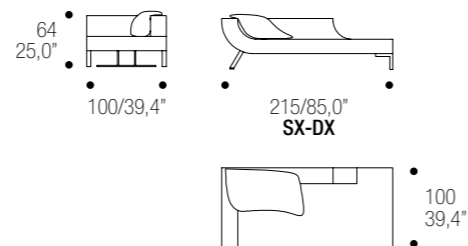

# ATOLLO

PAG. 80

## DIVANI/SOFAS

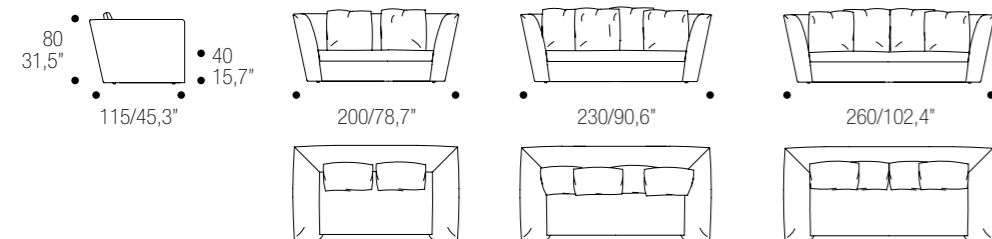

# ATOLLO

PAG. 80

## TERMINALI/TERMINALS DX-SX

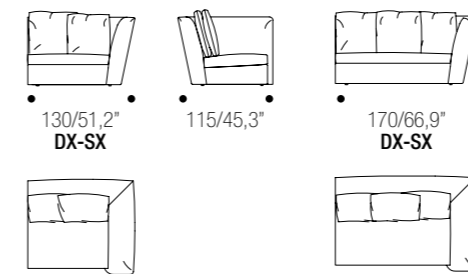

Elementi terminali  
con 1 bracciolo  
SG O DG  
End units with 1  
arm left or right

## ELEMENTI CENTRALI/CENTRAL UNITS

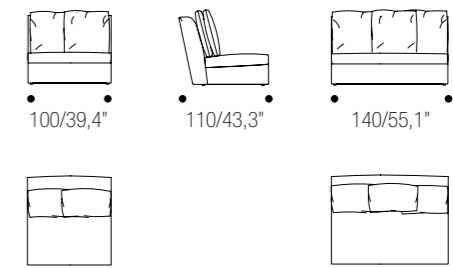

## ANGOLO/CORNER SX-DX

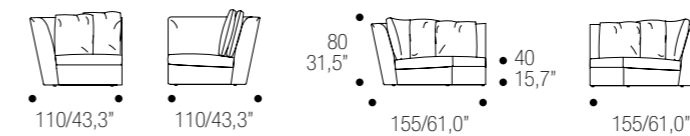

## ISOLA CON BRACCIOLO/ISLAND WITH ARM DX-SX

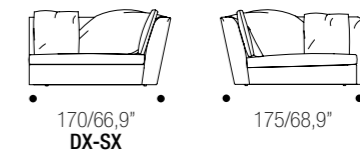

## CHAISE LONGUE DX-SX

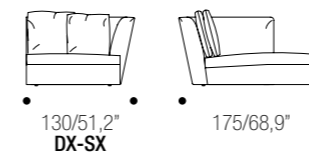

## POUFF

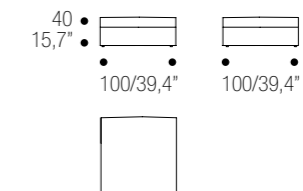

## COMPOSIZIONI/SECTIONALS

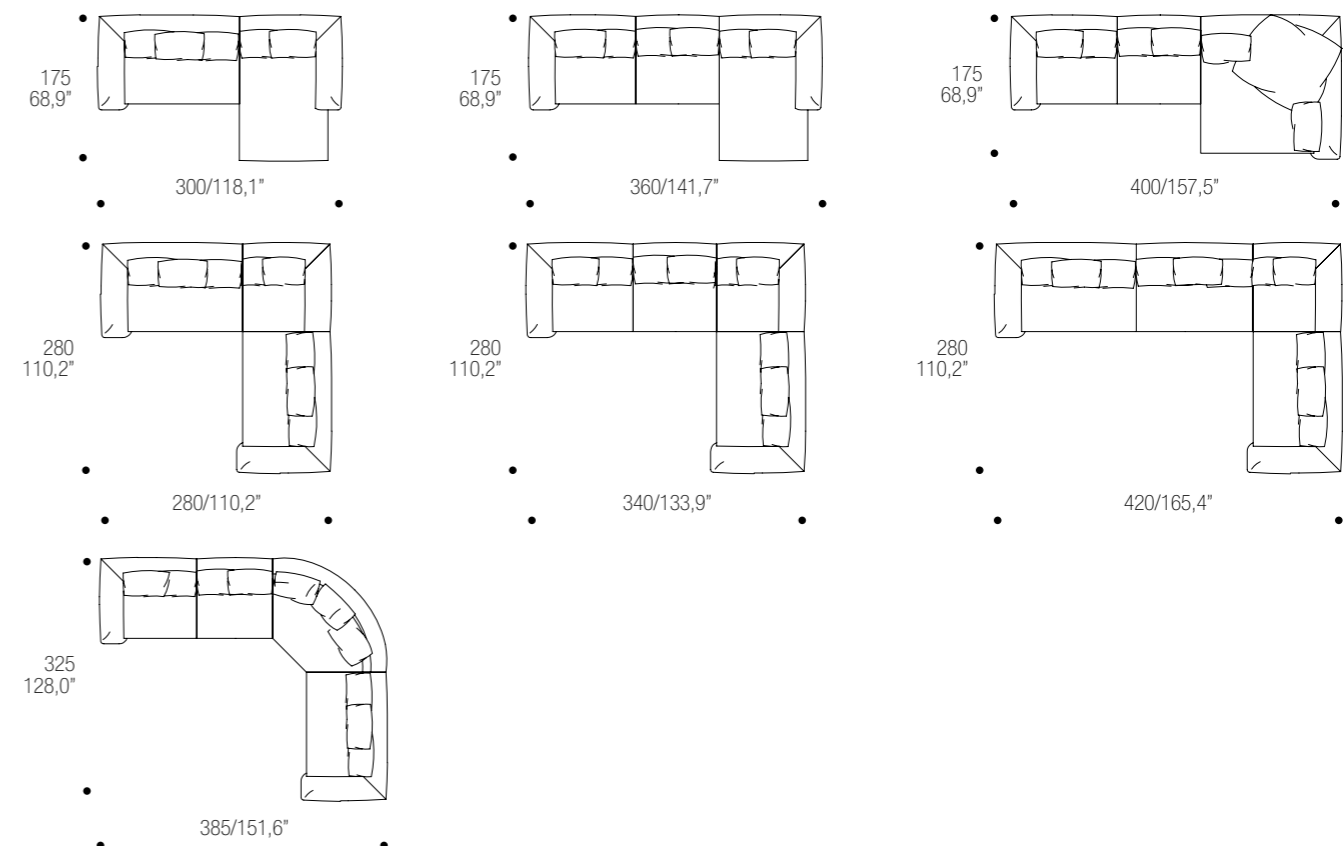

# BALLA CON ME

PAG. 86

## POLTRONA/ARMCHAIR

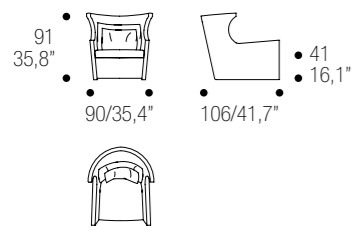

# OPALE

PAG. 90

## POLTRONA/ARMCHAIR

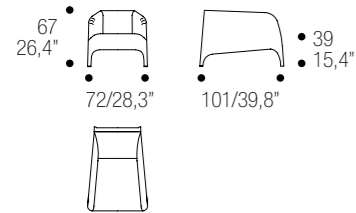

# NOTTURNO

PAG. 94

## CHAISE LONGUE DX-SX

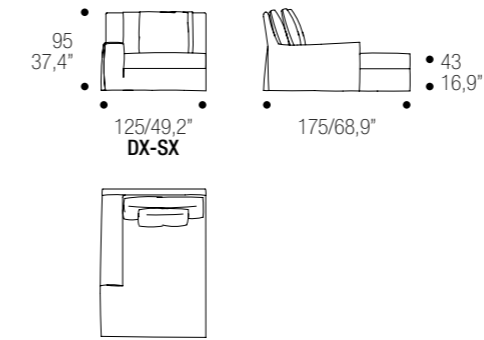

## COMPOSIZIONI/SECTIONALS

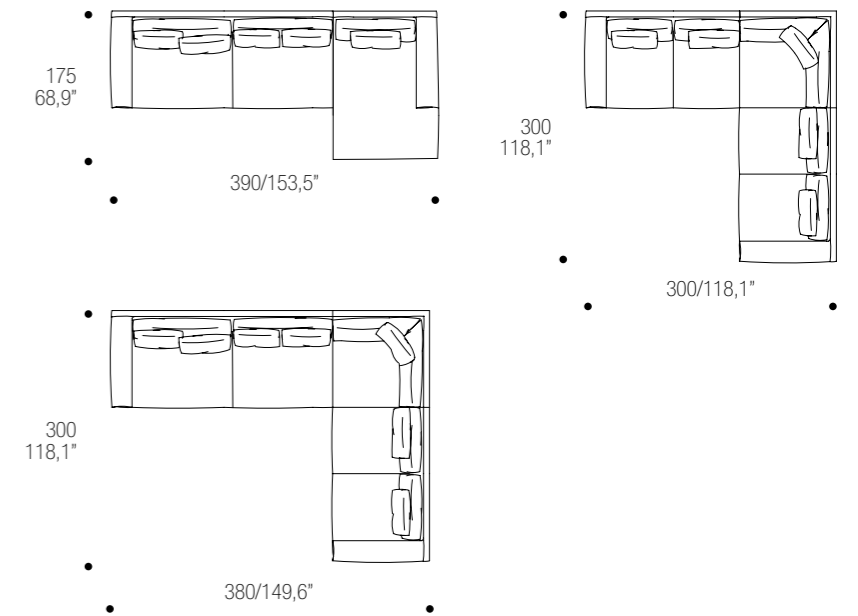

# NOTTURNO

PAG. 94

## POLTRONA/ARMCHAIR

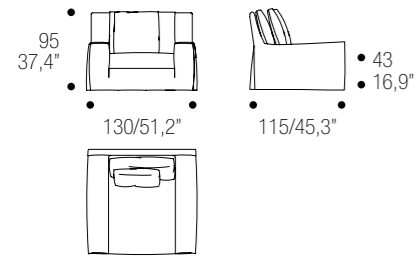

## DIVANI/SOFAS

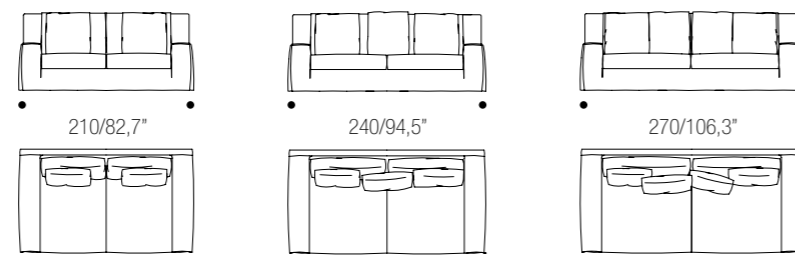

## ANGOLO/CORNER SX-DX

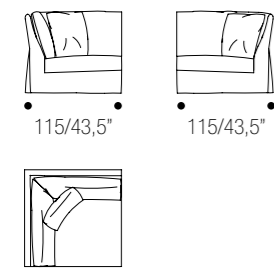

Elementi terminali  
con 1 bracciolo  
SG O DG  
*End units with 1  
arm left or right*

## TERMINALI/TERMINALS SX-DX

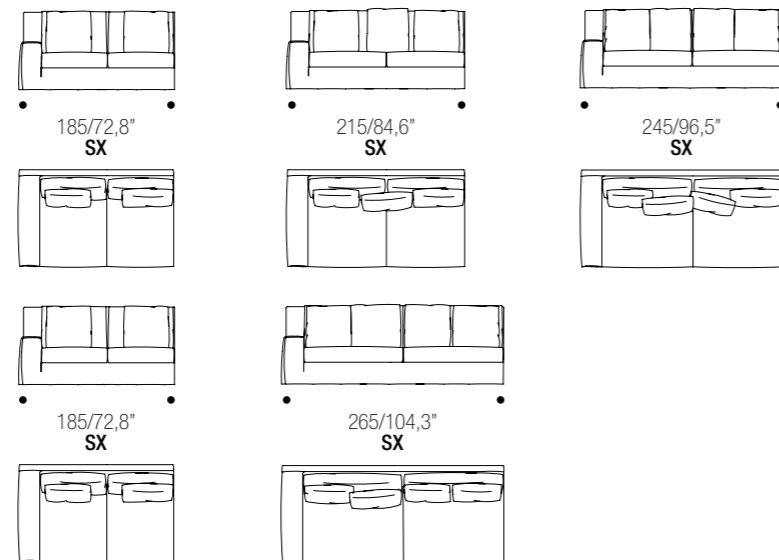

## CUSCINO/PILLOW

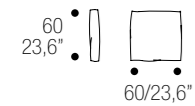

# LEGENDA

PAG. 98

## POLTRONA/ARMCHAIR

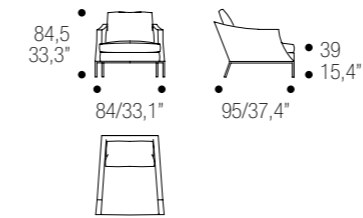

**DIVANI/SOFAS**

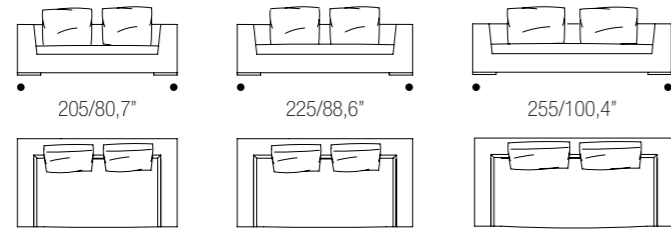
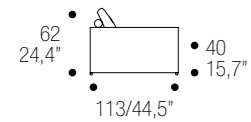

**CUSCINO/PILLOW**

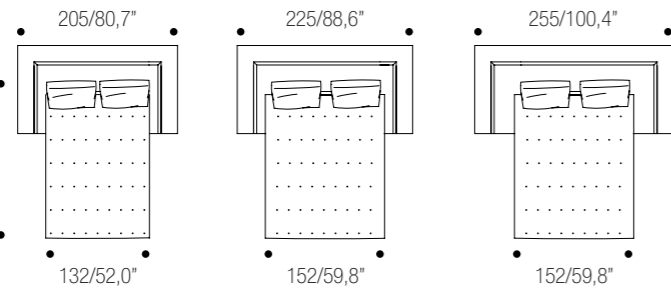
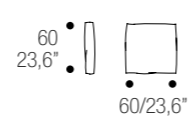

Rete elettrosaldata  
o a doghe, materasso  
altezza cm 7  
*Electrowelded net  
or wooden slates  
mattress thickness 3"*

247  
97,2\" 182  
71,7\"

**TERMINALI/TERMINALS SX-DX**

Elementi terminali  
con 1 bracciolo  
SG O DG  
*End units with 1  
arm left or right*

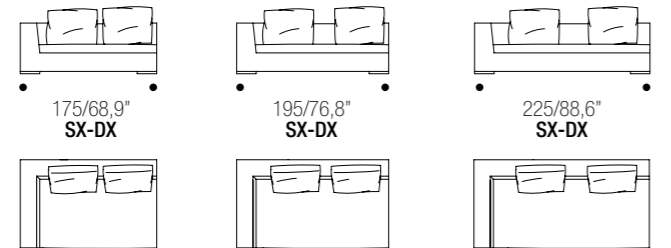

**ANGOLO/CORNER SX-DX**

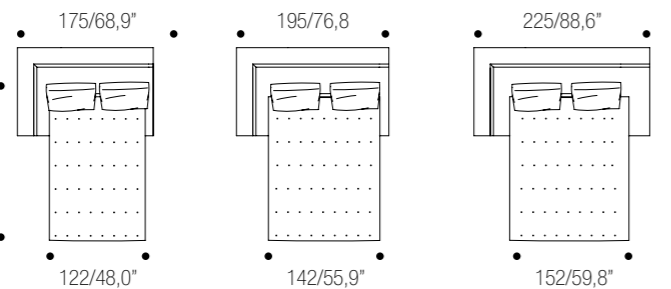
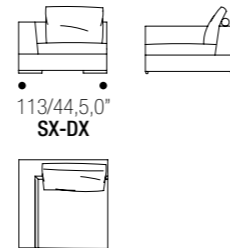

247  
97,2\" 182  
71,7\"

**CHAISE LONGUE SX-DX**

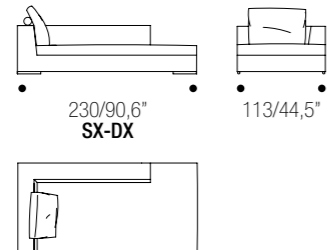
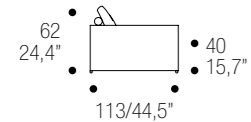

**CUSCINO/PILLOW**

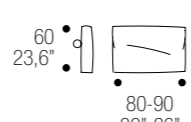

80-90  
32\"-36\"  
*Con rullo  
Whit cylindrical  
back*

**CILINDRO/CYLINDER**

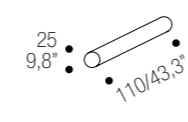

**ELEMENTI CENTRALI/CENTRAL UNITS**

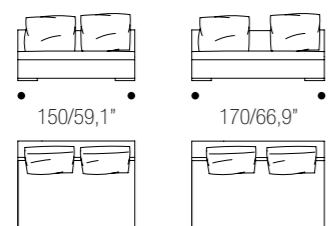

**POUFF**

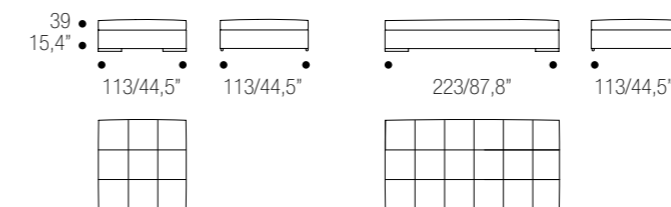

**COMPOSIZIONI/SECTIONALS**

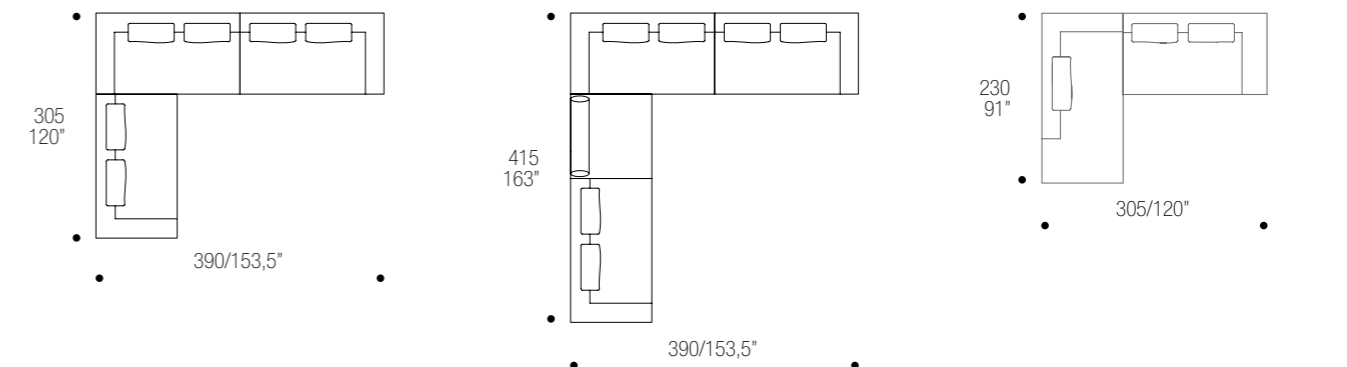
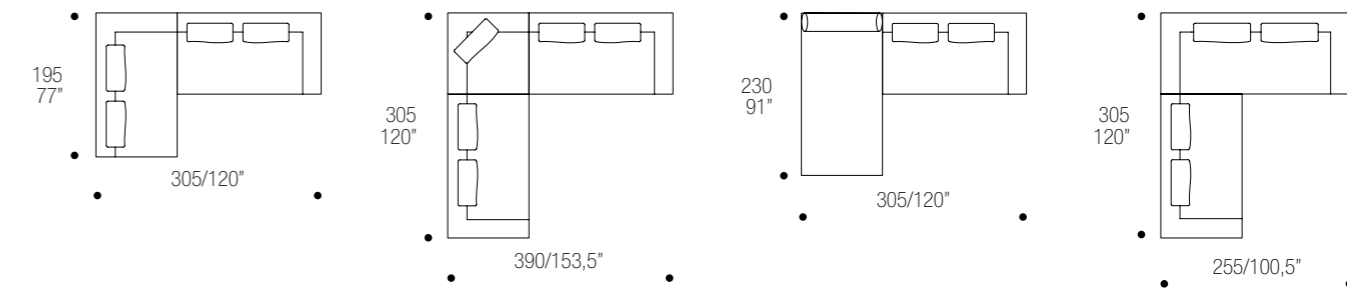
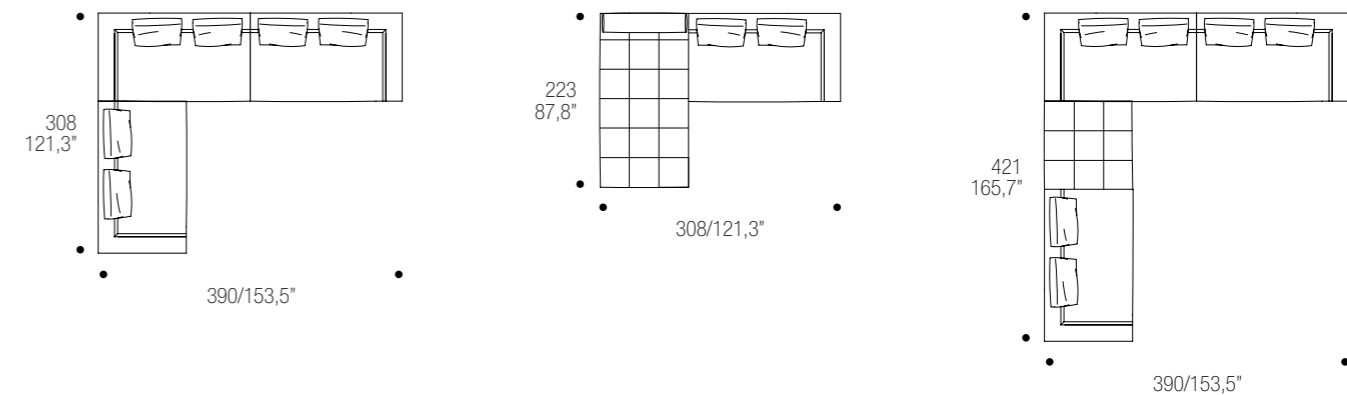

**FIORE**  
PAG. 108

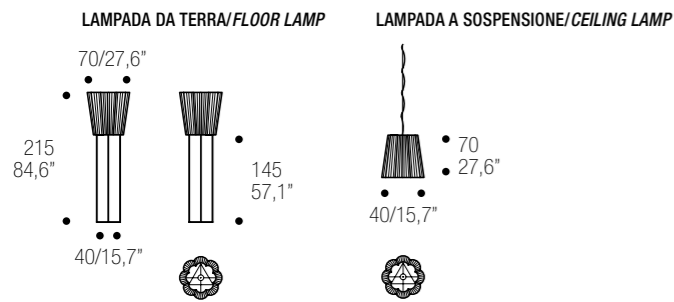

**DISCO**  
PAG. 114

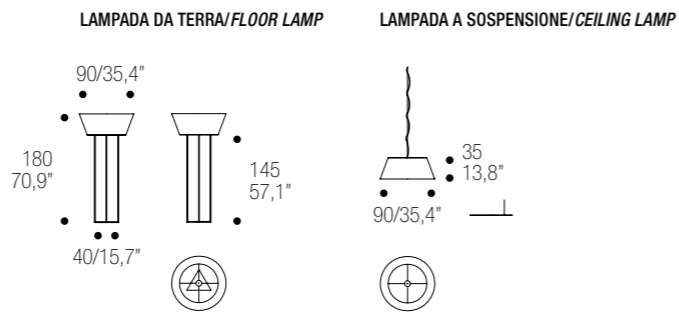

**TI AMO**  
PAG. 128



**RIFLESSO**  
PAG. 130

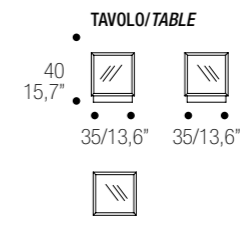

**ARTE**  
PAG. 118

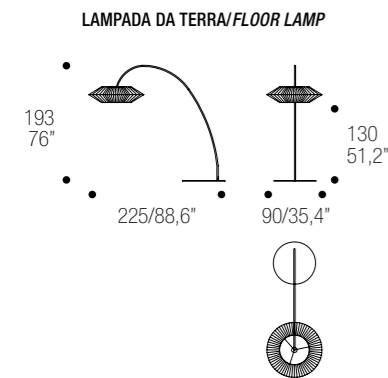

**MACCHIA**  
PAG. 116

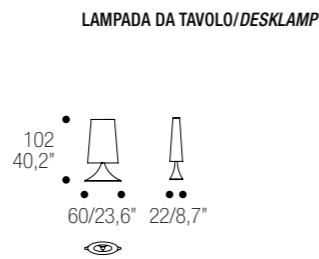

**PASO DOBLE**  
PAG. 132

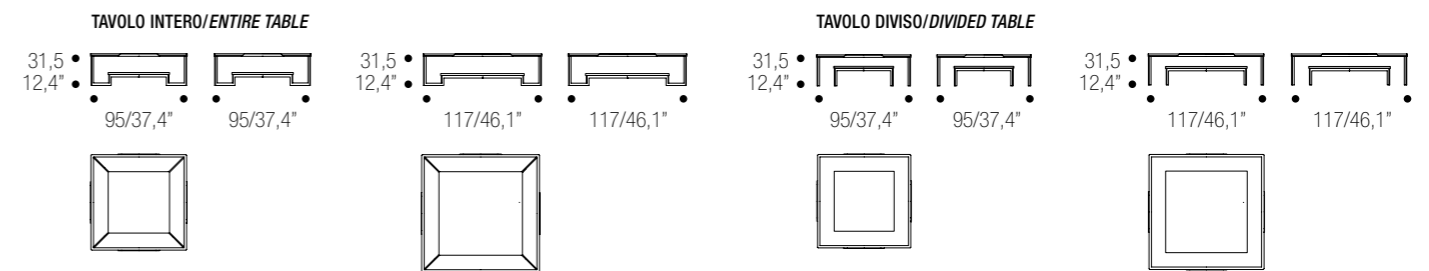

**LEGGERO**  
PAG. 134

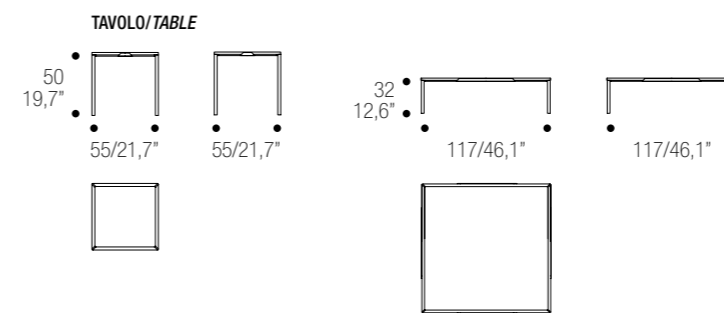

**ROCK COCO**  
PAG. 122

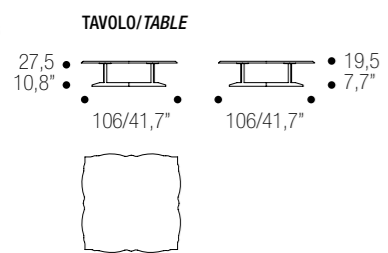

**NORD**  
PAG. 124

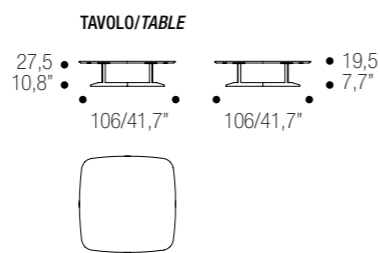

**LAMP AND COFFEE TABLE**  
PAG. 126

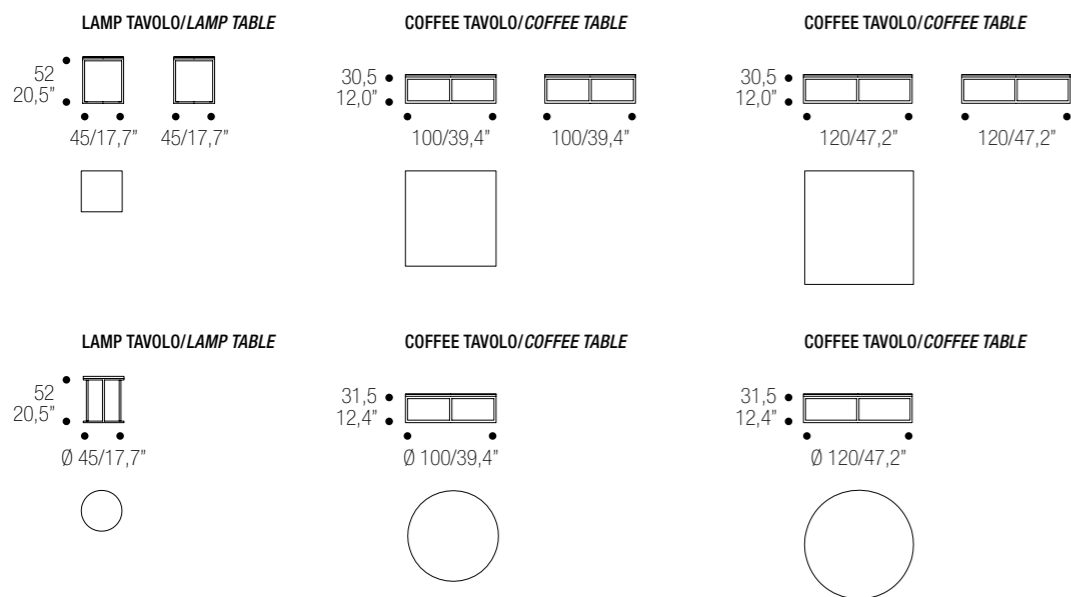

**ELEGANZA**  
PAG. 138

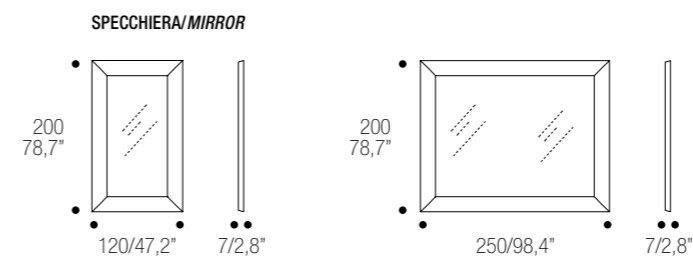

**I LOVE YOU**  
PAG. 144

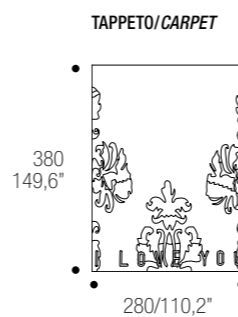

**SENSAZIONE**  
PAG. 150

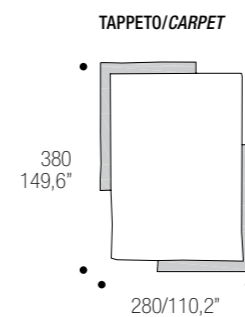



A.D.  
Giorgio Soressi



e r b a



erba

Erba Italia srl  
via della Misericordia 52  
20853 Biassono (MB)  
phone +39 039 490 632  
fax +39 039 491 582  
[www.erbaitalia.it](http://www.erbaitalia.it)  
[info@erbaitalia.it](mailto:info@erbaitalia.it)