

S C U L

T U R E

D I

L U C E

VENICEM

S C U L

T U R E

D I

L U C E

VENICEM

## INDEX

PINOCCHIO	8
URBAN	16
KITAMI	40
MONDRIAN	56
CIRCLE	84
ZOE	94
SECRET	104
NUMA	114
CHIC	118
CROWN	122
ROOTS	130
TECHNICAL DATA	137



## TIMELESS

Melissa e Massimo, dopo un proprio personale percorso di lavoro nel campo dell'illuminazione e del design d'interni, si uniscono e fondano nel 2013 VeniceM.

Ogni oggetto è ideato e pensato per dare un forte segno di riconoscibilità alla collezione VeniceM. Le forme semplici e la chiarezza nell'uso dei materiali sono contraddistinti dalla continua ricerca e la cura nei prodotti.

L'utilizzo di materiali nobili, l'ossidazione dell'ottone, l'imperfezione-perfezione del vetro, sono tra di loro combinati per dare forza ad oggetti "senza tempo".

Melissa and Massimo, after their own personal path in the field of lighting and interior design, joined together and founded in 2013 VeniceM. Each object is designed and created with the purpose of giving a strong sign of recognition to VeniceM collection and brand.

Simple forms and clarity in the use of materials are distinguished by the continuous research and product care.

The use of noble materials, brass oxidation, imperfection and perfection of glass are combined together to give strength to "timeless" objects.

















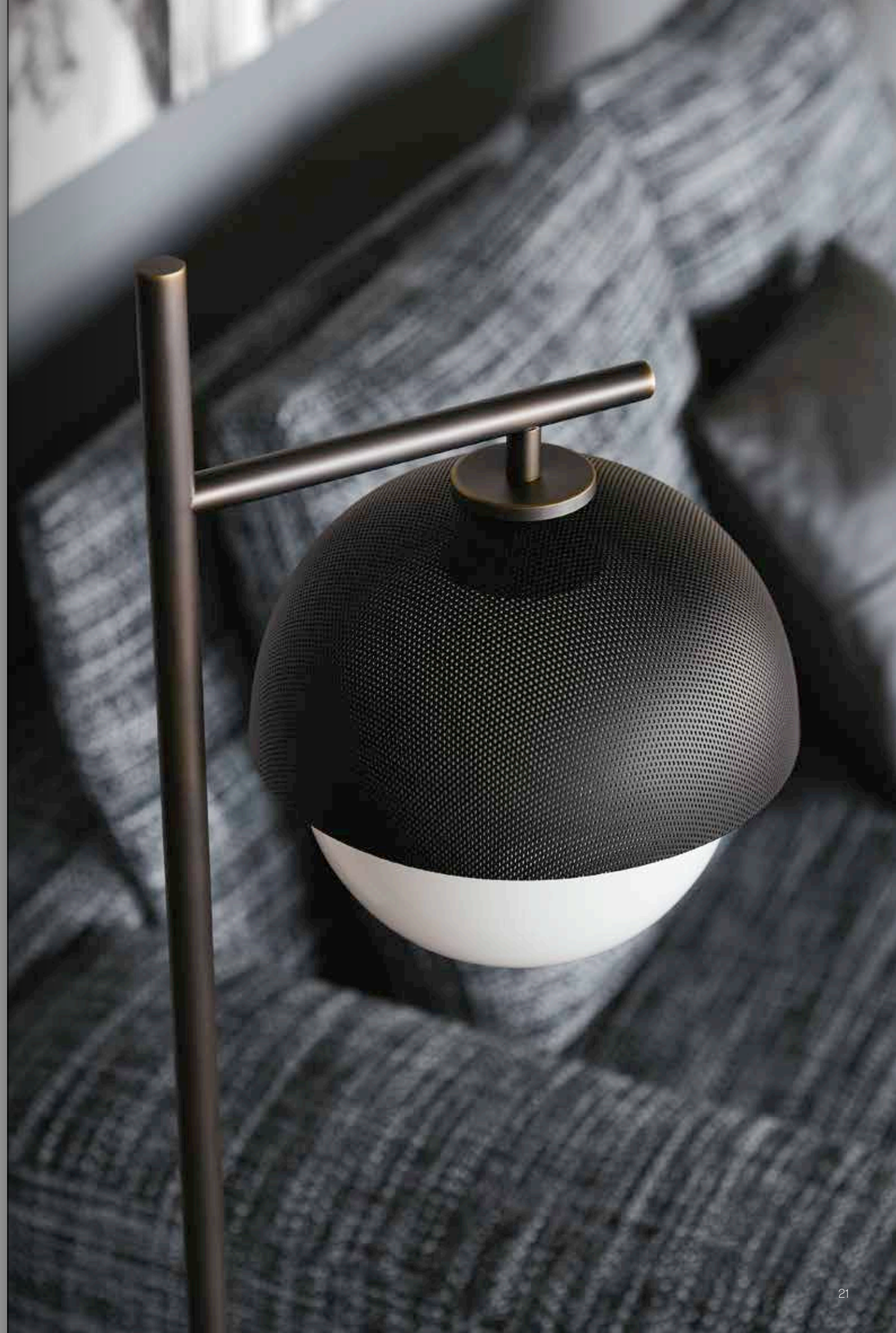



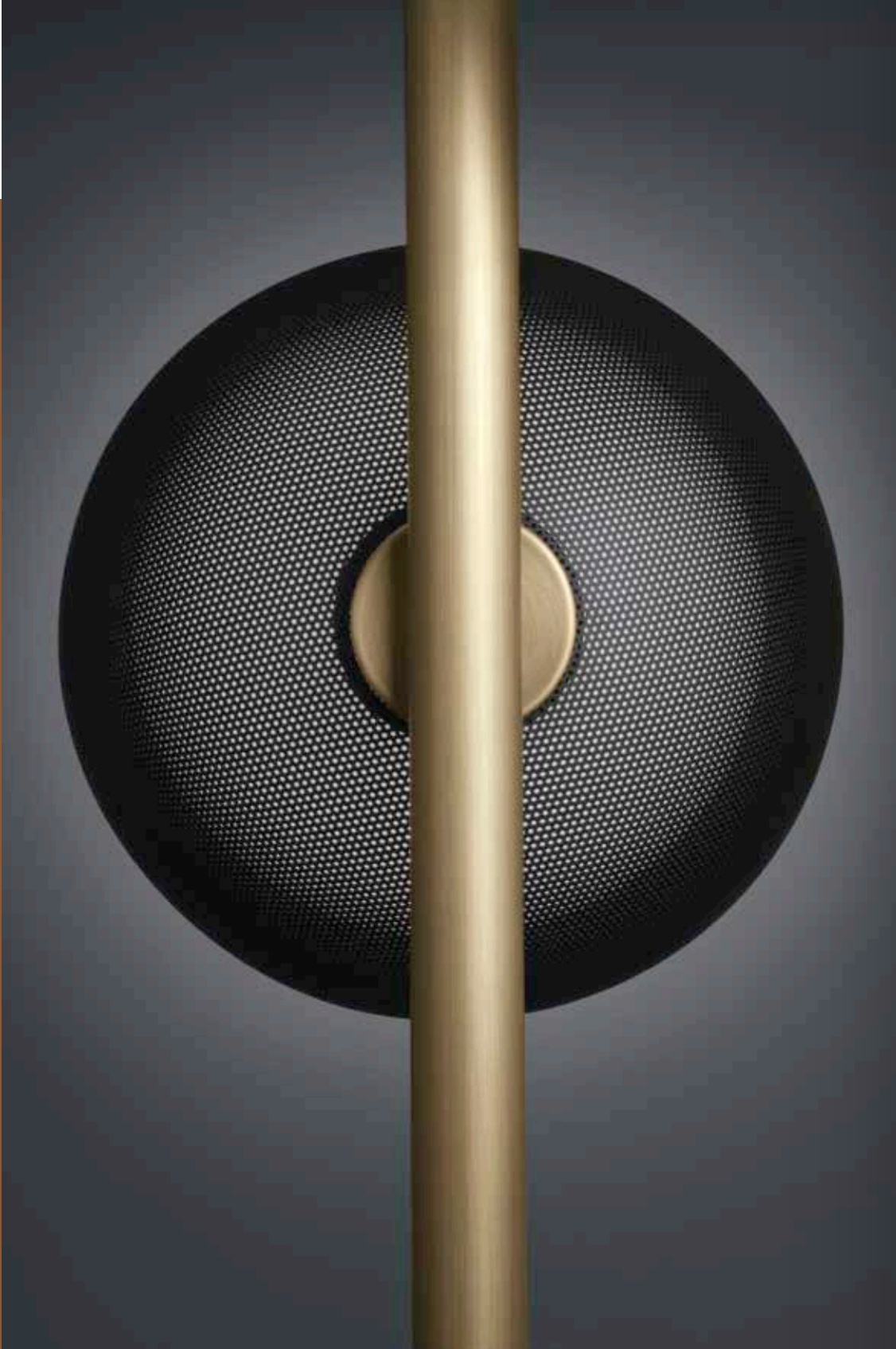



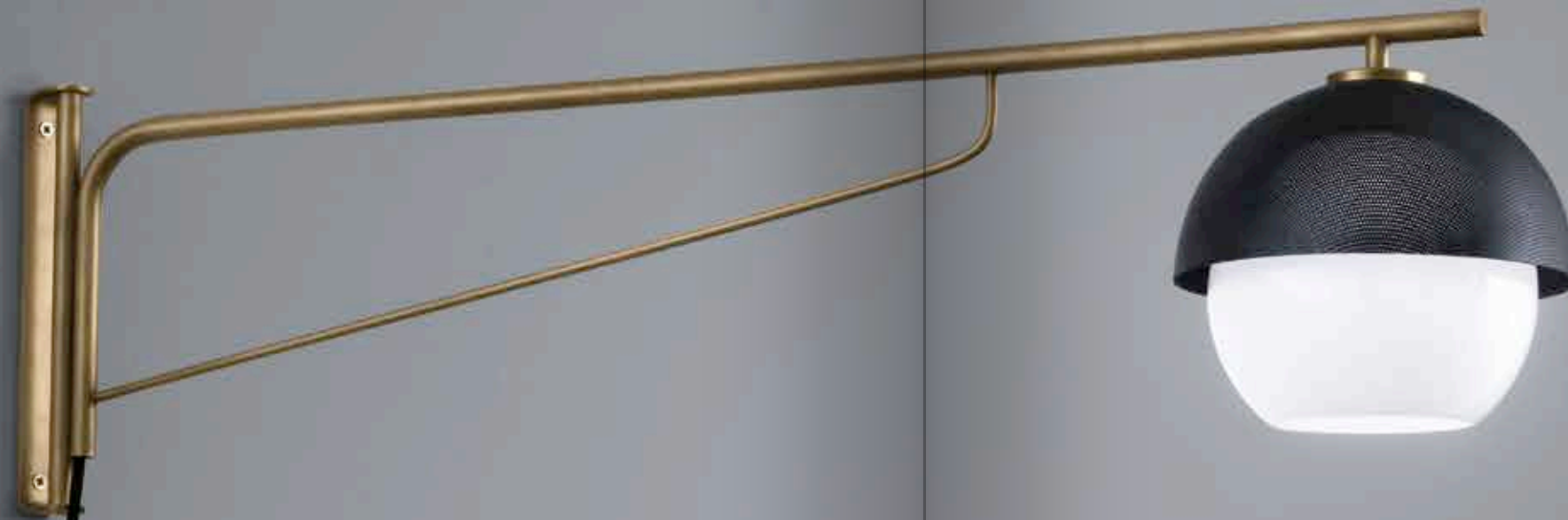













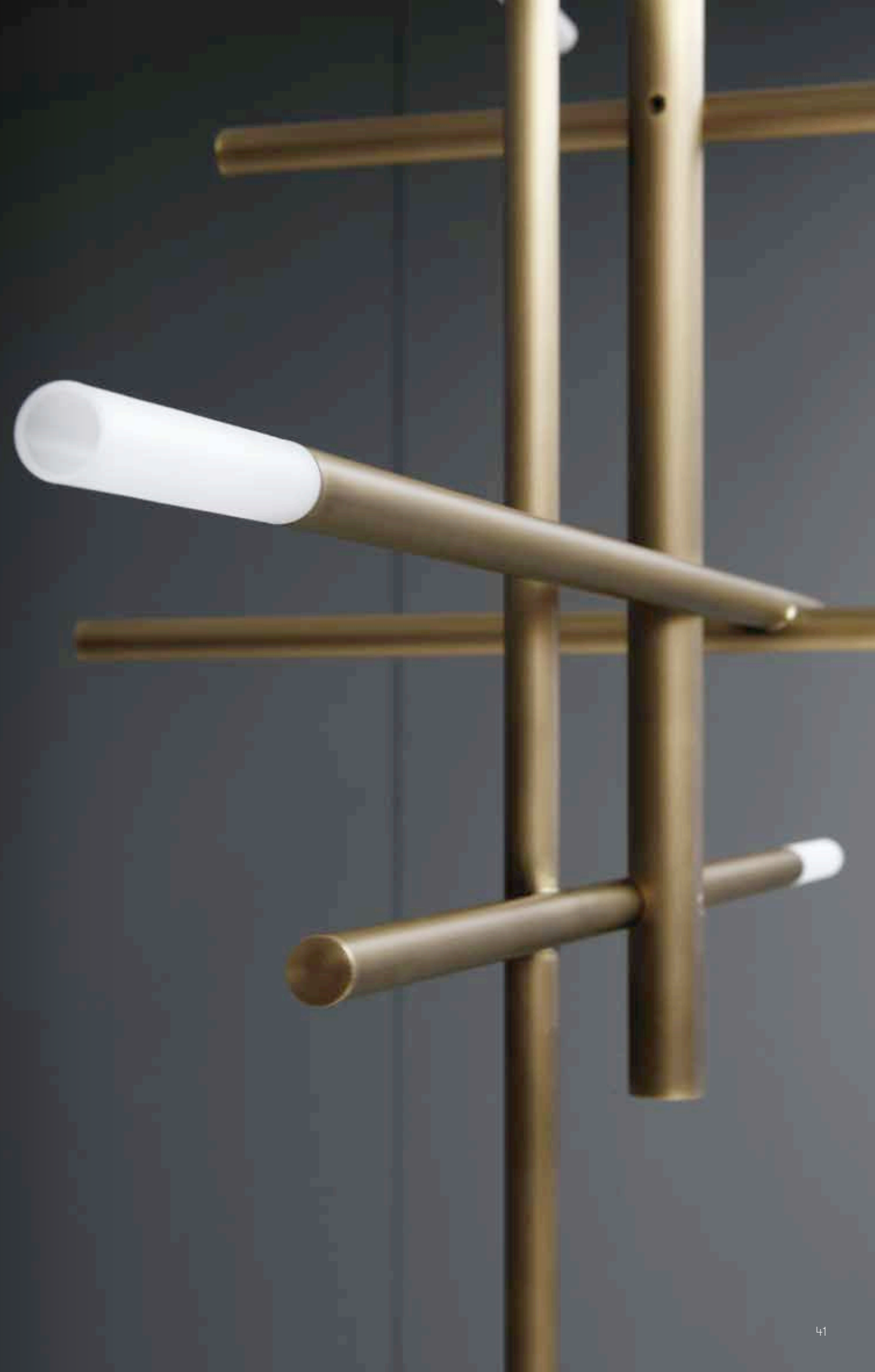

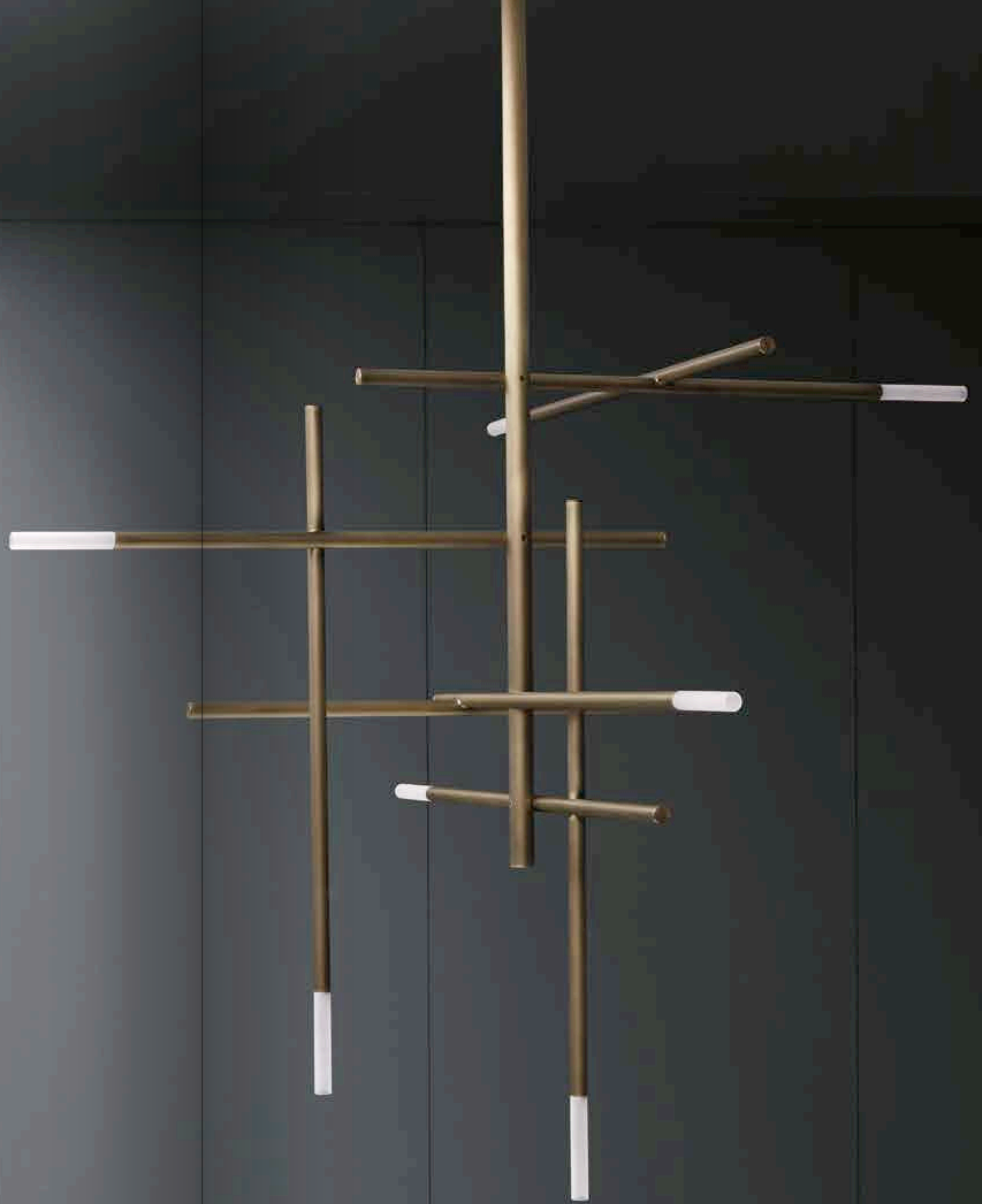













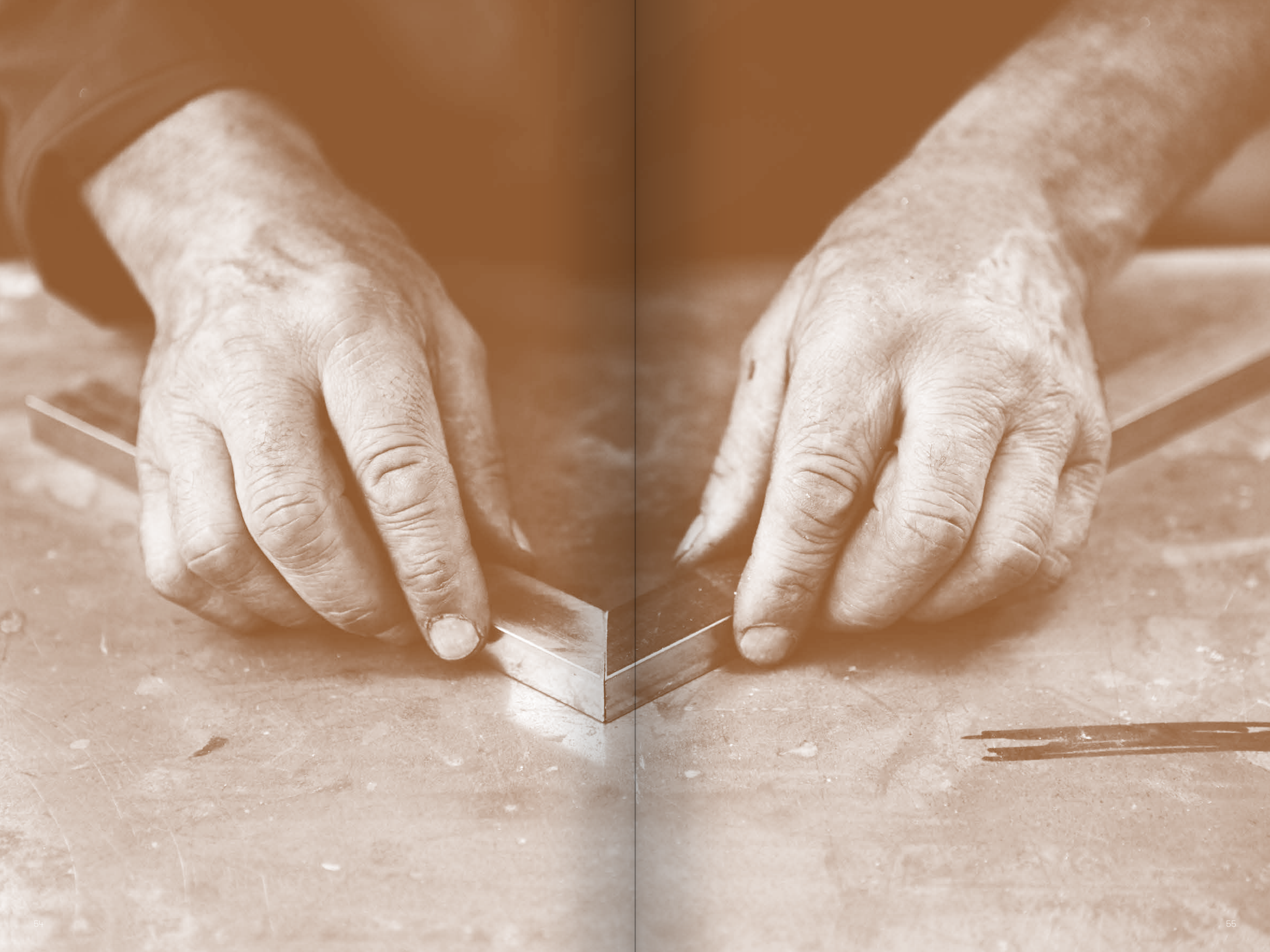





MONDRIAN GLASS FLOOR

















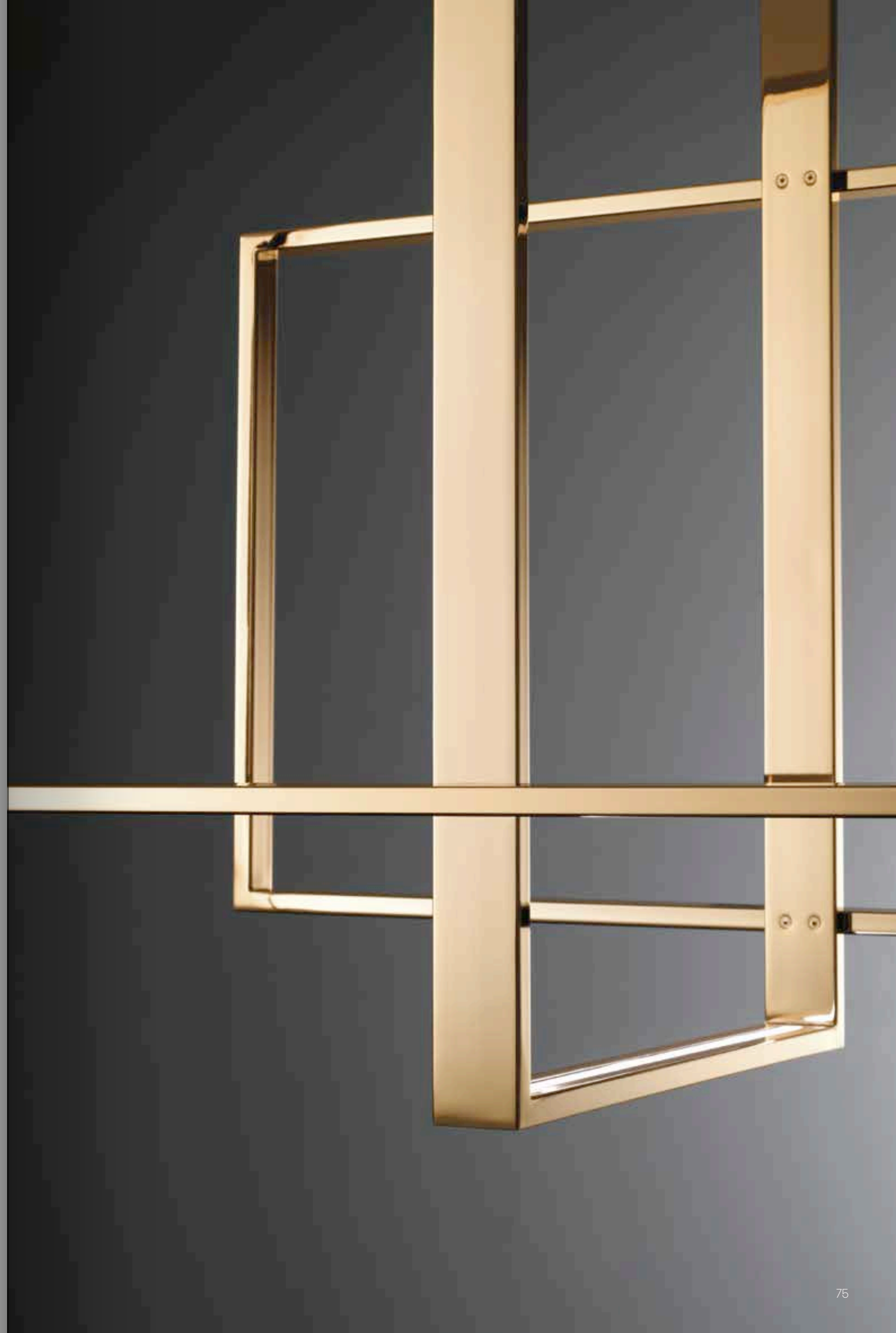
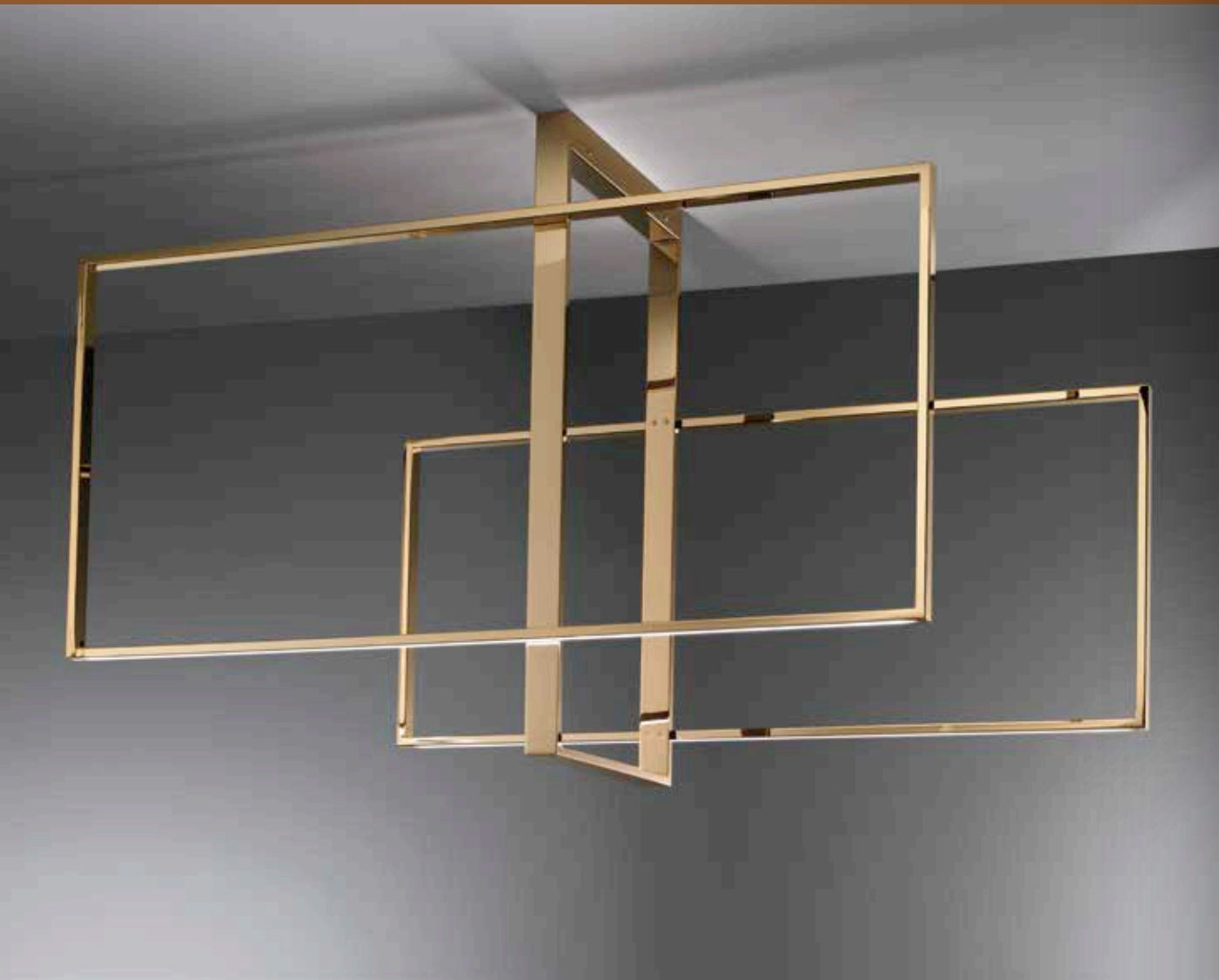















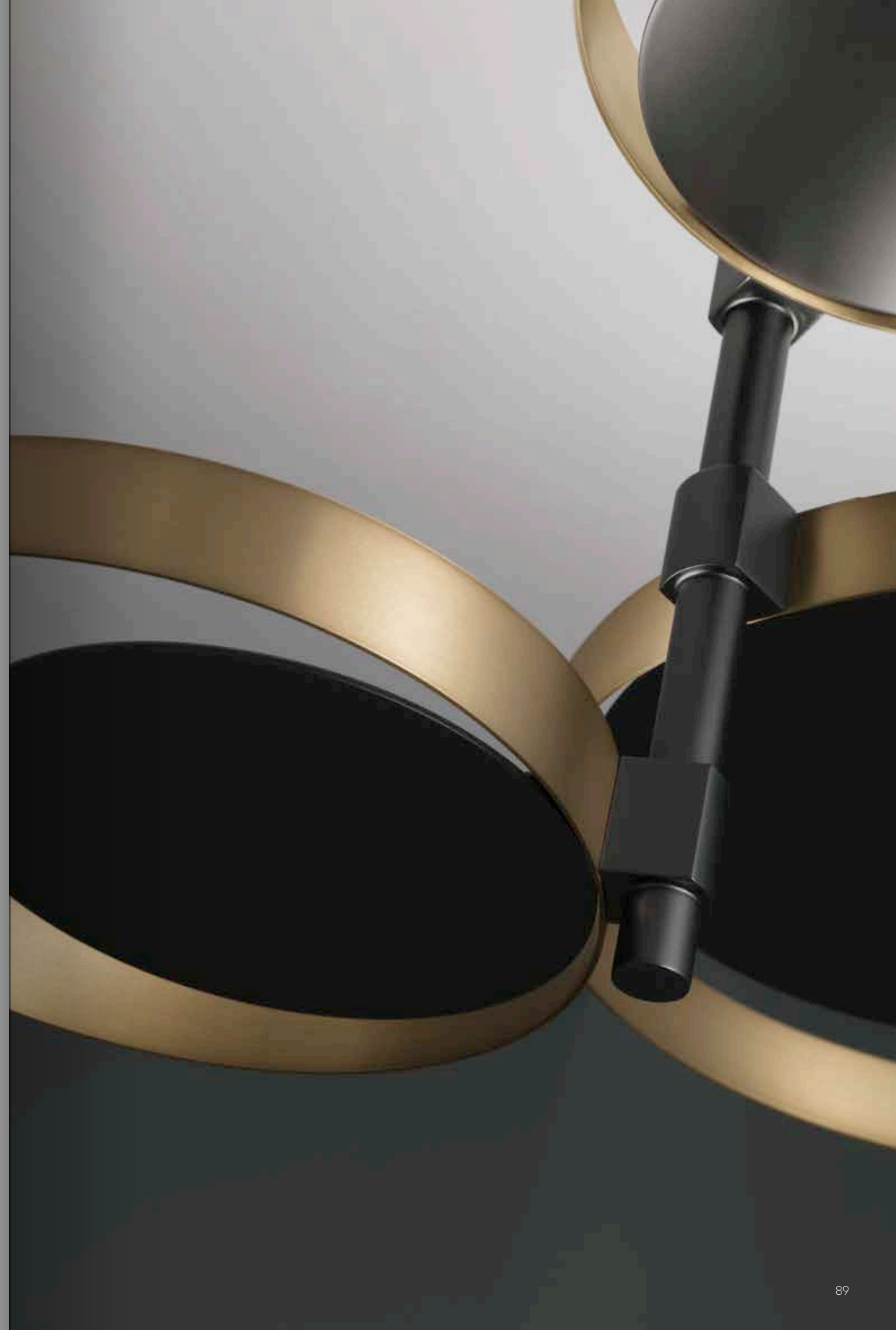



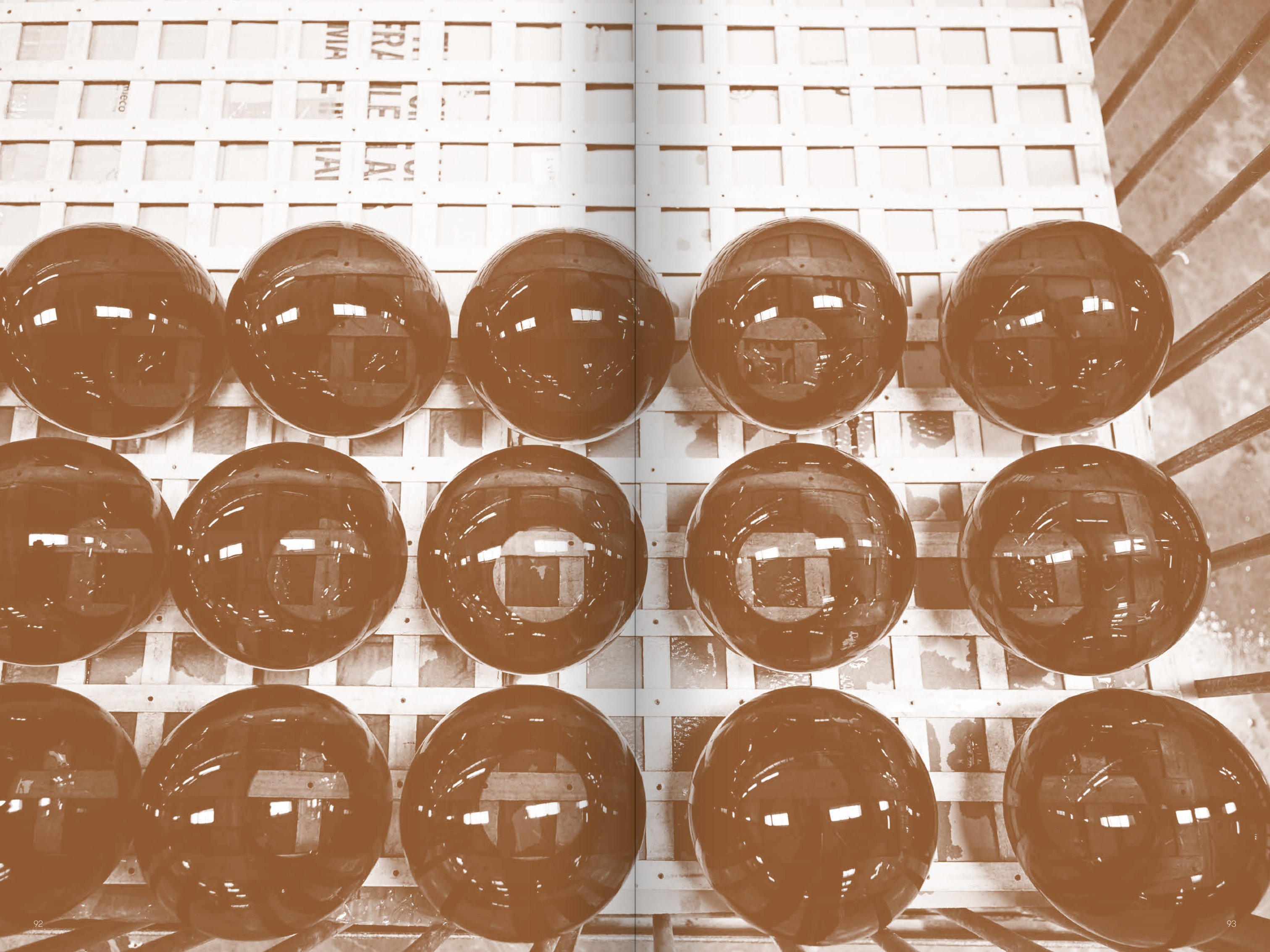







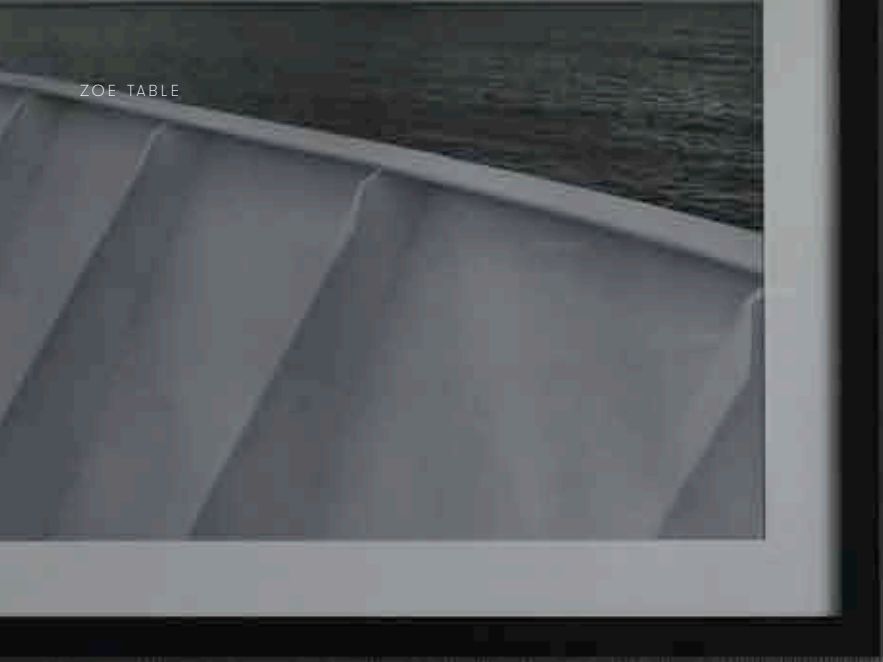



































ROOTS CHANDELIER





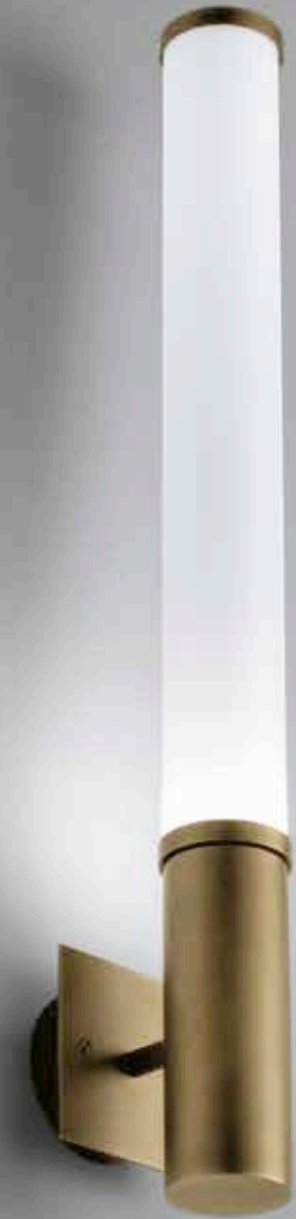

TECHNICAL DATA

CHIC  
CIRCLE  
CROWN  
KITAMI  
MONDRIAN  
NUMA  
PINOCCHIO  
ROOTS  
SECRET  
URBAN  
ZOE

## CHIC FLOOR

Floor lamp with diffused light. Dark bronze striped structure and crystal Murano blown glass trihedrons.

Lampada da terra a luce diffusa. Struttura in bronzo striato scuro e triedri in vetro soffiato di Murano color cristallo.

P. 118

1x75W E27 PAR30 halogen 650lm 2900°K  
+ 1x53W E27 halogen 1320lm 2800°K  
or  
1x9W E27 PAR30 LED 766lm 2700°K  
+ 1x7W E27 LED 560lm 2700°K

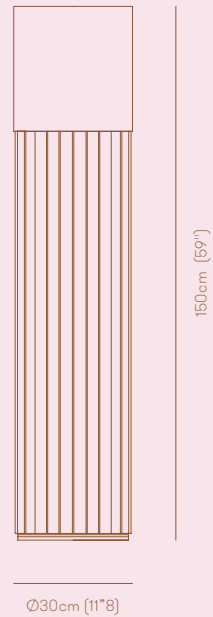

## CHIC TABLE

Table lamp with diffused light. Dark bronze striped structure and crystal Murano blown glass trihedrons.

Lampada da tavolo a luce diffusa. Struttura in bronzo striato scuro e triedri in vetro soffiato di Murano color cristallo.

P. 120

1x35W GU10 PAR16 halogen 200lm 2700°K  
+ 1x30W E14 halogen 405lm 2700°K  
or  
1x4,3W GU10 PAR16 LED 350lm 2700°K  
+ 1x5,7W E14 LED 470lm 2700°K

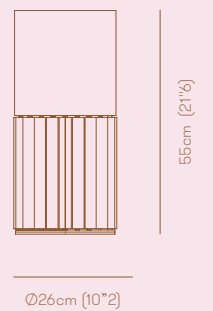

## CIRCLE WALL 25/35

Wall lamp with indirect light. Satinated natural brass ring and matte black nickel structure.

Lampada da parete a luce indiretta. Anello in ottone naturale satinato e struttura in nichel nero opaco.

P. 84

1x17W 1500lm 2700°K CRI90

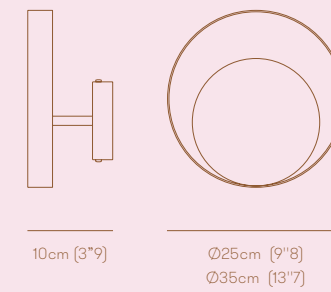

## CIRCLE CEILING

Ceiling lamp with indirect light. Satinated natural brass rings and matte black nickel structure.

Lampada da soffitto a luce indiretta. Anelli in ottone naturale satinato e struttura in nichel nero opaco.

P. 88

3x17W 1500lm 2700°K CRI90

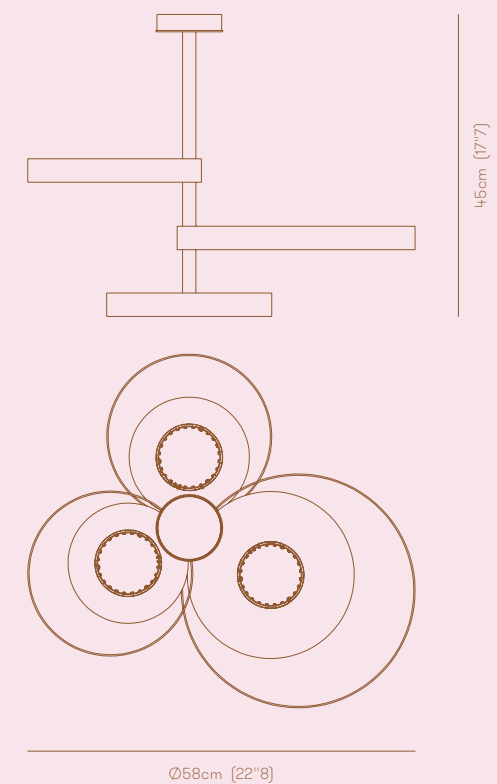

## CROWN SUSPENSION

Suspended lamp with diffused light. Dark bronze striped structure and crystal, amber or smoke grey Murano blown glass trihedrons.

Lampada a sospensione a luce diffusa. Struttura in bronzo striato scuro e triedri in vetro soffiato di Murano color cristallo, ambra o grigio fumé.

P. 122

5×53W E27 halogen 1320lm 2800°K  
or 5×7W E27 LED 560lm 2700°K

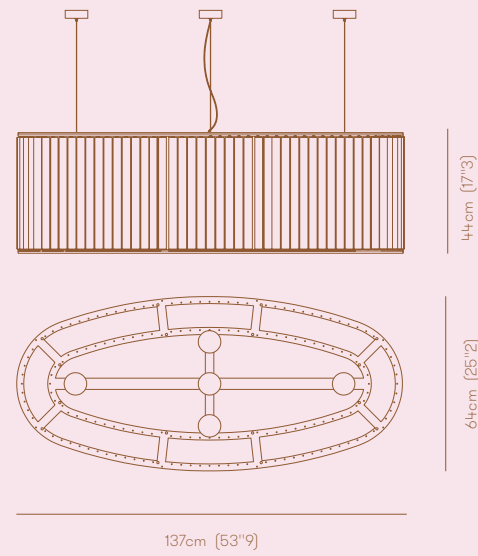

## CROWN WALL

Wall lamp with diffused light. Dark bronze striped structure and crystal, amber or smoke grey Murano blown glass trihedrons.

Lampada da parete a luce diffusa. Struttura in bronzo striato scuro e triedri in vetro soffiato di Murano color cristallo, ambra o grigio fumé.

P. 126

1×53W E27 halogen 1320lm 2800°K  
or 1×7W E27 LED 560lm 2700°K

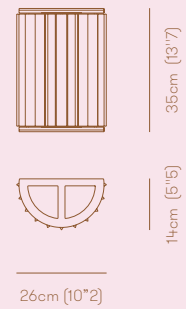

## KITAMI SUSPENSION

Suspended lamp with diffused light. Polished black nickel, polished gold or light burnished brass structure and satinated glass diffusers.

Lampada a sospensione a luce diffusa. Struttura in nichel nero lucido, oro lucido od ottone brunito chiaro e diffusori in vetro satinato.

P. 40

LARGE  
8×2W G4 LED 200lm 2700°K  
MEDIUM  
6×2W G4 LED 200lm 2700°K

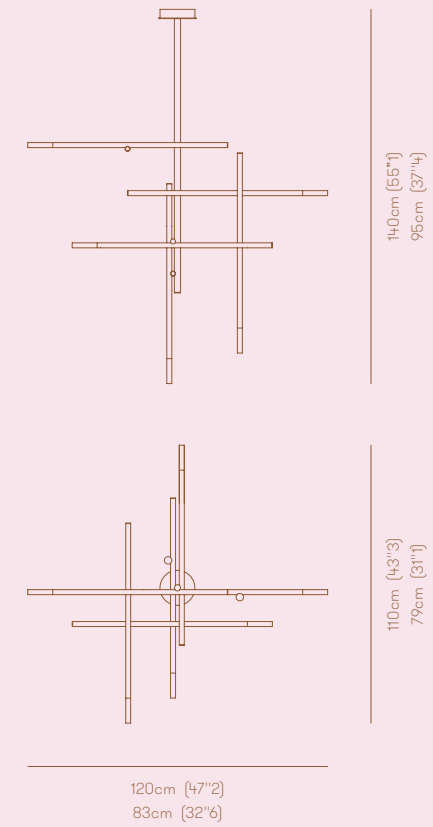

## KITAMI WALL

Wall lamp with diffused light. Polished black nickel, polished gold or light burnished brass structure and satinated glass diffusers.

Lampada da parete a luce diffusa. Struttura in nichel nero lucido, oro lucido od ottone brunito chiaro e diffusori in vetro satinato.

P. 46

4×2W G4 LED 200lm 2700°K

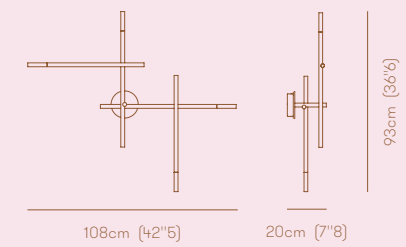



## MONDRIAN GLASS CEILING

Ceiling lamp with diffused light.  
Burnished natural brass, polished black nickel or polished gold structure and white, amethyst or smoke grey Murano blown glass diffusers.

Lampada da soffitto a luce diffusa.  
Struttura in ottone naturale brunito, nichel nero lucido od oro lucido e diffusori in vetro soffiato di Murano color bianco, ametista o grigio fumé.

P. 56

5×MAX 33W G9 halogen 460lm 2700°K  
or 5×4,5W G9 LED 350lm 2700°K

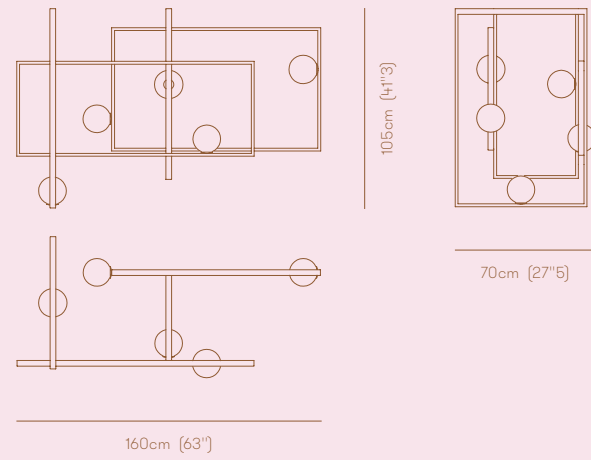

## MONDRIAN GLASS FLOOR

Floor lamp with diffused light.  
Burnished natural brass, polished black nickel or polished gold structure and white, amethyst or smoke grey Murano blown glass diffusers.

Lampada da terra a luce diffusa.  
Struttura in ottone naturale brunito, nichel nero lucido od oro lucido e diffusori in vetro soffiato di Murano color bianco, ametista o grigio fumé.

P. 60

3×MAX 33W G9 halogen 460lm 2700°K  
or 3×4,5W G9 LED 350lm 2700°K

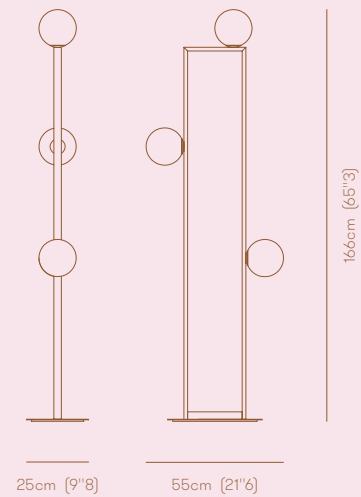

## MONDRIAN GLASS WALL

Wall lamp with diffused light.  
Burnished natural brass, polished black nickel or polished gold structure and white, amethyst or smoke grey Murano blown glass diffuser.

Lampada da parete a luce diffusa.  
Struttura in ottone naturale brunito, nichel nero lucido od oro lucido e diffusore in vetro soffiato di Murano color bianco, ametista o grigio fumé.

P. 64

1×MAX 33W G9 halogen 460lm 2700°K  
or 1×4,5W G9 LED 350lm 2700°K

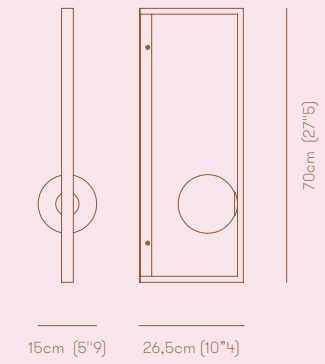

## MONDRIAN LED CEILING

Ceiling lamp with direct and indirect light. Polished black nickel, polished gold or light burnished brass structure.

Lampada da soffitto a luce diretta e indiretta. Struttura in nichel nero lucido, oro lucido od ottone brunito chiaro.

P. 70

Strip LED 34W 2265lm 2700°K CRI85

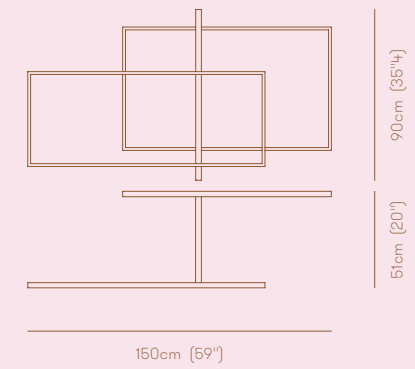

## MONDRIAN LED WALL

Wall lamp with direct and indirect light. Polished black nickel, polished gold or light burnished brass structure.

Lampada da parete a luce diretta e indiretta. Struttura in nichel nero lucido, oro lucido od ottone brunito chiaro.

P. 76

Strip LED 16W 1025lm 2700°K CRI85

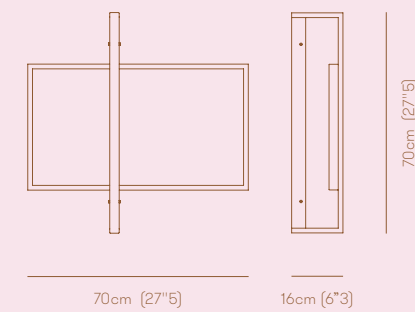

## NUMA SUSPENSION

Suspended lamp with diffused light. Dark burnished brass structure and crystal Murano blown glass trihedrons.

Lampada a sospensione a luce diffusa. Struttura in ottone brunito scuro e triedri in vetro soffiato di Murano color cristallo.

P. 114

1x17W LED 1500lm 2700°K CRI90

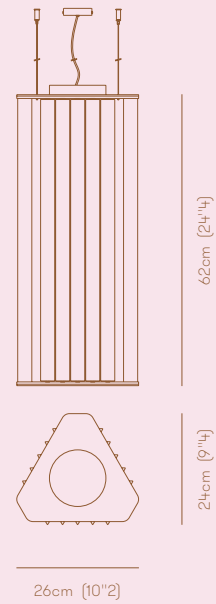

## PINOCCHIO FLOOR

Floor lamp with diffused and direct light. Dark burnished brass structure with polished gold metal spheres. White Murano blown glass diffusers and crystal Murano blown glass trihedrons.

Lampada da terra a luce diffusa e diretta. Struttura in ottone brunito scuro con sfere di metallo in oro lucido. Diffusori in vetro soffiato di Murano color bianco e triedri in vetro soffiato di Murano color cristallo.

P. 8

2xMAX 33W G9 halogen 460lm 2700°K  
+ Strip LED 9W 580lm 2700°K CRI85  
or  
2x4,5W G9 LED 350lm 2700°K  
+ Strip LED 9W 580lm 2700°K CRI85

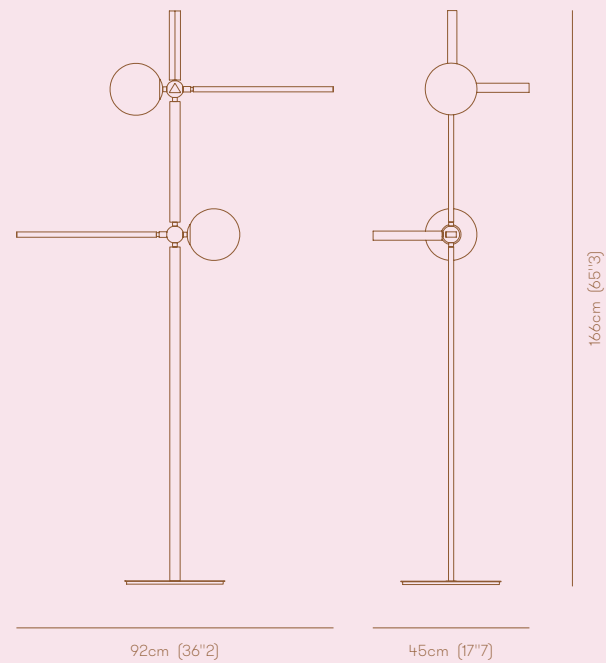

## ROOTS CHANDELIER

Suspended lamp diffused light. Light burnished brass structure and clear or white Murano blown glass diffusers.

Lampada a sospensione a luce diffusa. Struttura in ottone brunito chiaro e diffusori in vetro soffiato di Murano color trasparente o bianco.

P. 130

10x4,5W G9 LED 350lm 2700°K

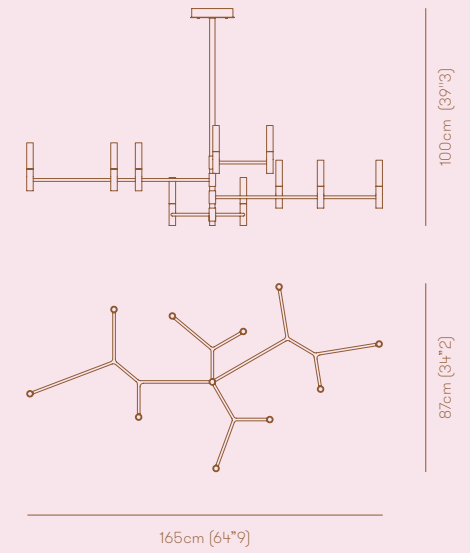

## ROOT ONE WALL

Wall lamp with diffused light. Light burnished brass structure and clear or white Murano blown glass diffuser.

Lampada da parete a luce diffusa. Struttura in ottone brunito chiaro e diffusore in vetro soffiato di Murano color trasparente o bianco.

P. 134

1x4,5W G9 LED 350lm 2700°K

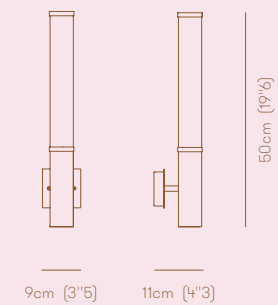

## SECRET FLOOR

Floor lamp with indirect light.  
Satinated natural brass and matte  
black nickel structure.

Lampada da terra a luce indiretta.  
Struttura in ottone naturale satinato  
e nichel nero opaco.

P. 104

Strip LED 36W 2400lm 2700°K CR85

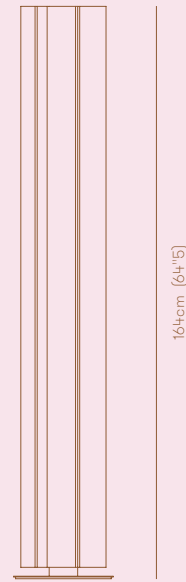

164cm (64"6)

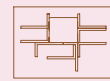

22cm (8"6)

30cm (11"8)

## SECRET WALL

Wall lamp with indirect light.  
Satinated natural brass and matte  
black nickel structure.

Lampada da parete a luce indiretta.  
Struttura in ottone naturale satinato  
e nichel nero opaco.

P. 108

Strip LED 16W 1060lm 2700°K CRI85

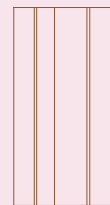

50cm (19"6)

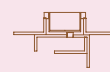

13,5cm (5"3)

25cm (9"8)

## URBAN CEILING

Ceiling lamp with diffused light. Light  
or dark burnished brass structure  
with matte gold or matte black  
perforated metal lampshade.  
White Murano blown glass diffuser.

Lampada da soffitto a luce diffusa.  
Struttura in ottone brunito chiaro  
o scuro con paralume in metallo  
microforato color oro opaco o nero  
opaco. Diffusore in vetro soffiato di  
Murano color bianco.

P. 34

1xMAX 33W G9 halogen 460lm 2700°K  
or 1x4,5W G9 LED 350lm 2700°K

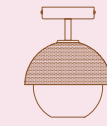

26cm (9"8)

Ø20cm (7"8)

## URBAN WALL

Wall lamp with diffused light. Light or  
dark burnished brass structure with  
matte gold or matte black perforated  
metal lampshade. White Murano  
blown glass diffuser.

Lampada da parete a luce diffusa.  
Struttura in ottone brunito chiaro  
o scuro con paralume in metallo  
microforato color oro opaco o nero  
opaco. Diffusore in vetro soffiato di  
Murano color bianco.

P. 34

1xMAX 33W G9 halogen 460lm 2700°K  
or 1x4,5W G9 LED 350lm 2700°K

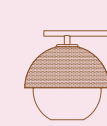

26cm (10")

25cm (9"8)

## URBAN SUSPENSION 1

Suspended lamp with diffused  
light. Light or dark burnished brass  
structure with matte gold or matte  
black perforated metal lampshade.  
White Murano blown glass diffuser.

Lampada a sospensione a luce  
diffusa. Struttura in ottone brunito  
chiaro o scuro con paralume in  
metallo microforato color oro opaco  
o nero opaco. Diffusore in vetro  
soffiato di Murano color bianco.

P. 36

1xMAX 33W G9 halogen 460lm 2700°K  
or 1x4,5W G9 LED 350lm 2700°K

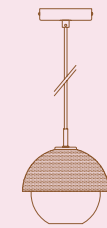

150cm (59")

Ø20cm (7"8)

### URBAN SUSPENSION 3

Suspended lamp with diffused light. Light or dark burnished brass structure with matte gold or matte black perforated metal lampshades. White Murano blown glass diffusers.

Lampada a sospensione a luce diffusa. Struttura in ottone brunito chiaro o scuro con paralumi in metallo microforato color oro opaco o nero opaco. Diffusori in vetro soffiato di Murano color bianco.

P. 24

3xMAX 33W G9 halogen 460lm 2700°K  
or 3x4,5W G9 LED 350lm 2700°K

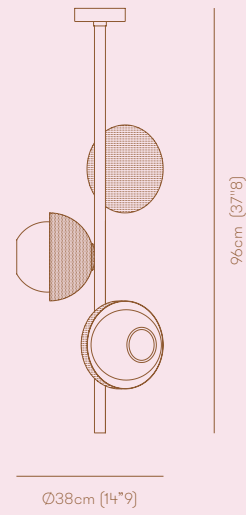

### URBAN WALL TURNING ARM

Adjustable wall lamp with diffused light. Light or dark burnished brass structure with matte gold or matte black perforated metal lampshade. White Murano blown glass diffuser.

Lampada da parete con braccio orientabile a luce diffusa. Struttura in ottone brunito chiaro o scuro con paralume in metallo microforato color oro opaco o nero opaco. Diffusore in vetro soffiato di Murano color bianco.

P. 26

1xMAX 33W G9 halogen 460lm 2700°K  
or 1x4,5W G9 LED 350lm 2700°K

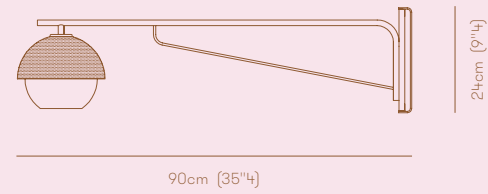

### URBAN TABLE

Table lamp with diffused light. Light or dark burnished brass structure with matte gold or matte black perforated metal lampshade. White Murano blown glass diffuser.

Lampada da tavolo a luce diffusa. Struttura in ottone brunito chiaro o scuro con paralume in metallo microforato color oro opaco o nero opaco. Diffusore in vetro soffiato di Murano color bianco.

P. 30

1xMAX 33W G9 halogen 460lm 2700°K  
or 1x4,5W G9 LED 350lm 2700°K

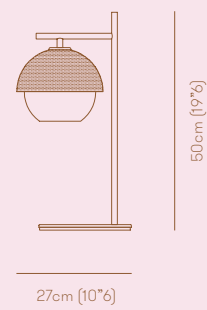

### URBAN FLOOR 1

Floor lamp with diffused light. Light or dark burnished brass structure with matte gold or matte black perforated metal lampshade. White Murano blown glass diffuser.

Lampada da terra a luce diffusa. Struttura in ottone brunito chiaro o scuro con paralume in metallo microforato color oro opaco o nero opaco. Diffusore in vetro soffiato di Murano color bianco.

P. 20

1xMAX 33W G9 halogen 460lm 2700°K  
or 1x4,5W G9 LED 350lm 2700°K

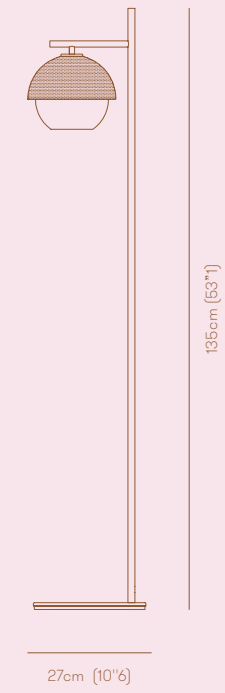

### URBAN FLOOR 3

Floor lamp with diffused light. Light or dark burnished brass structure with matte gold or matte black perforated metal lampshades. White Murano blown glass diffusers.

Lampada da terra a luce diffusa. Struttura in ottone brunito chiaro o scuro con paralumi in metallo microforato color oro opaco o nero opaco. Diffusori in vetro soffiato di Murano color bianco.

P. 16

3xMAX 33W G9 halogen 460lm 2700°K  
or 3x4,5W G9 LED 350lm 2700°K

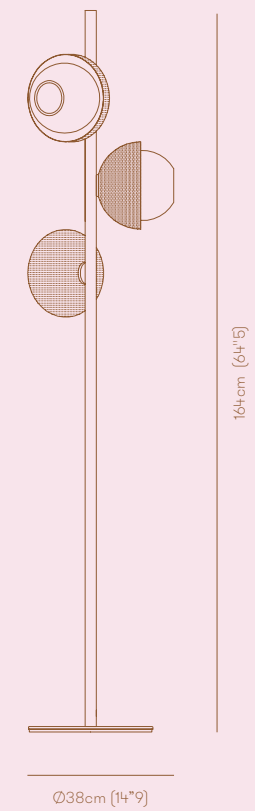

## ZOE FLOOR

Floor lamp with diffused light.  
Polished black nickel, polished gold,  
polished chrome or light burnished  
brass structure and white Murano  
blown glass diffusers. Polished black  
nickel, polished gold, polished chrome  
or polished copper metal spheres.

Lampada da terra a luce diffusa.  
Struttura in nichel nero lucido, oro  
lucido, cromo lucido od ottone  
brunito chiaro e diffusori in vetro  
soffiato di Murano color bianco. Sfere  
di metallo in nichel nero lucido, oro  
lucido, cromo lucido o rame lucido.

P. 94

3×MAX 33W G9 halogen 460lm 2700°K  
or 3×4,5W G9 LED 350lm 2700°K

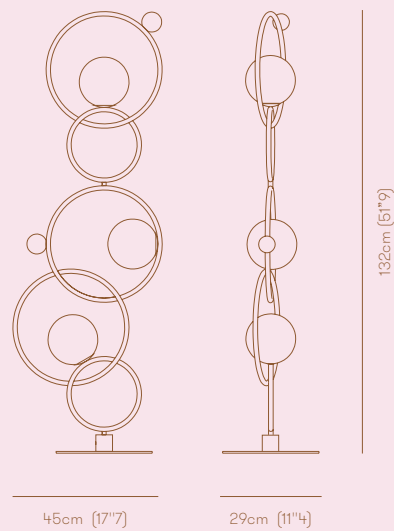

## ZOE TABLE

Table lamp with diffused light.  
Polished black nickel, polished gold,  
polished chrome or light burnished  
brass structure and white Murano  
blown glass diffuser. Polished black  
nickel, polished gold, polished chrome  
or polished copper metal sphere.

Lampada da tavolo a luce diffusa.  
Struttura in nichel nero lucido, oro  
lucido, cromo lucido od ottone  
brunito chiaro e diffusore in vetro  
soffiato di Murano color bianco. Sfera  
di metallo in nichel nero lucido, oro  
lucido, cromo lucido o rame lucido.

P. 96

1×MAX 33W G9 halogen 460lm 2700°K  
or 1×4,5W G9 LED 350lm 2700°K

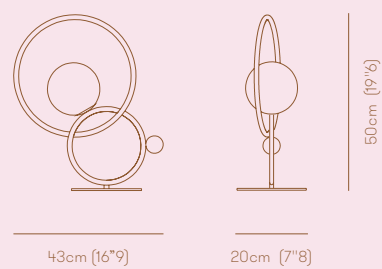

## ZOE WALL

Wall lamp with diffused light. Polished  
black nickel, polished gold, polished  
chrome or light burnished brass  
structure and white Murano blown  
glass diffuser. Polished black nickel,  
polished gold, polished chrome or  
polished copper metal sphere.

Lampada da parete a luce diffusa.  
Struttura in nichel nero lucido, oro  
lucido, cromo lucido od ottone  
brunito chiaro e diffusore in vetro  
soffiato di Murano color bianco. Sfera  
di metallo in nichel nero lucido, oro  
lucido, cromo lucido o rame lucido.

1×MAX 33W G9 halogen 460lm 2700°K  
or 1×4,5W G9 LED 350lm 2700°K

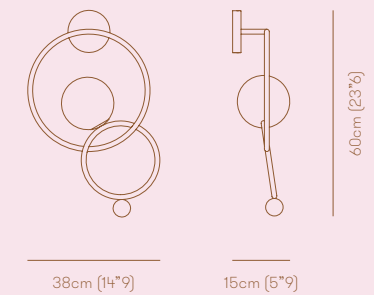

#### Concept & Graphic Design

Ottone Studio

#### Photographer

Federico Marin

#### Selection & Post Productions

Z13 Verona

#### Print

Grafiche Antiga

#### Edition 2017

VeniceM si riserva il diritto di apportare, senza preavviso, ogni modifica mirata al miglioramento funzionale e qualitativo dei prodotti. Testi e disegni presenti in questo stampato hanno scopo divulgativo; per ogni aspetto tecnico e dimensionale fare riferimento ai listini aziendali e relativi aggiornamenti. I campioni di colore e materiali hanno valore indicativo.

VeniceM reserves the rights at all time to apply modifications for the functional or qualitative improvement of its products. Texts and drawings present in this brochure have a divulgative purpose: for every technical and dimensional aspect please refer to the company's price lists and their relative updates. The colour and material samples have an indicative value.

© VeniceM - Tutti i diritti sono riservati a norma di legge / All rights reserved  
Il marchio VeniceM è proprietà della VeniceM srl / Trade Mark VeniceM

#### VENICEM S.R.L.

via Terraglio, 17, interno 3  
31021 Mogliano Veneto (TV)  
Italy

T / F (+39) 041 593 6143  
info@venicem.com  
www.venicem.com

MADE IN ITALY

[VENICEM.COM](http://VENICEM.COM)