

News 2020

Smart Lighting



LEDS C4

Smart Lighting

Control solutions let lighting to be adapted to the needs of people, spaces and organisations. For instance, lighting can be adjusted depending on the time of day, the job being done or how the space is being used.

Proper, connected lighting not only has a positive effect on people's well-being, but also a major influence on space management. The potential to collect useful data showing energy consumption, how different areas are occupied and what use they are being put to, means you can detect more strategic and efficient opportunities and make more efficient decisions.

Application examples

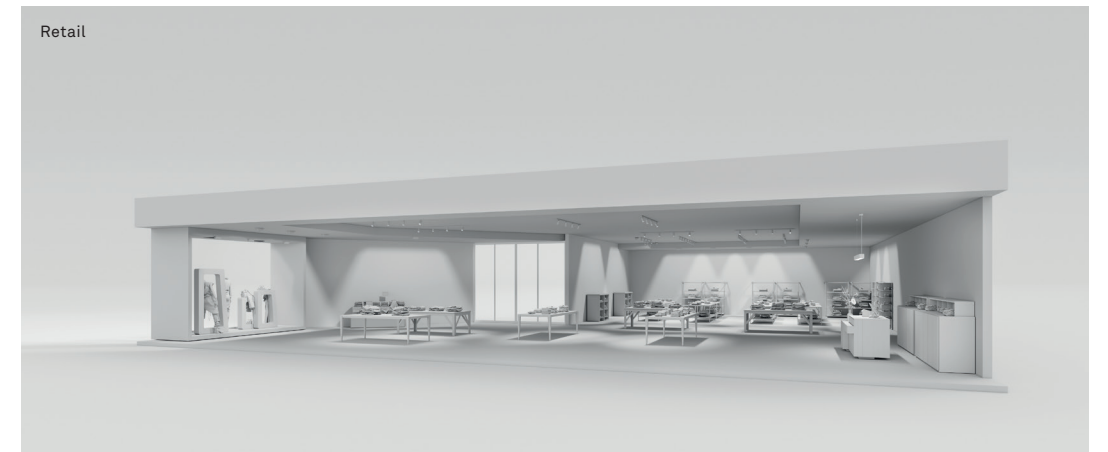
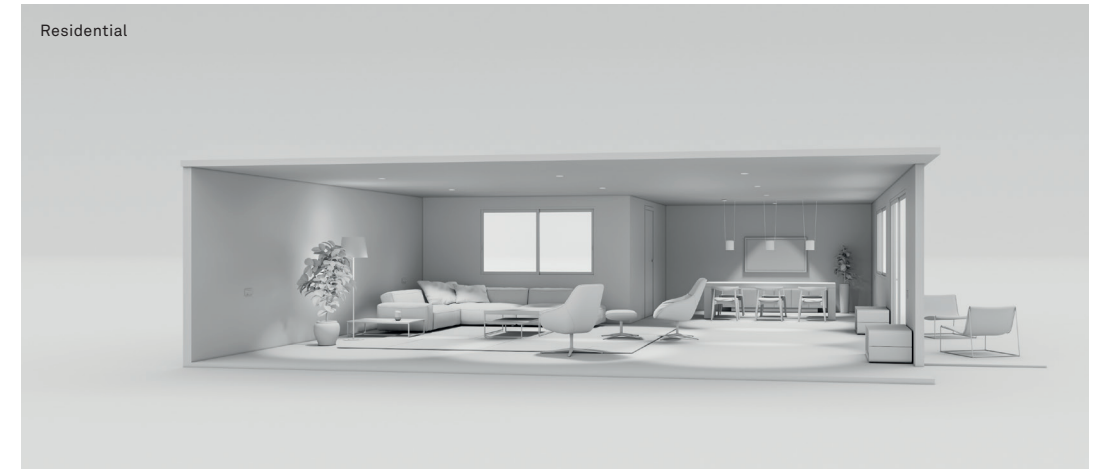
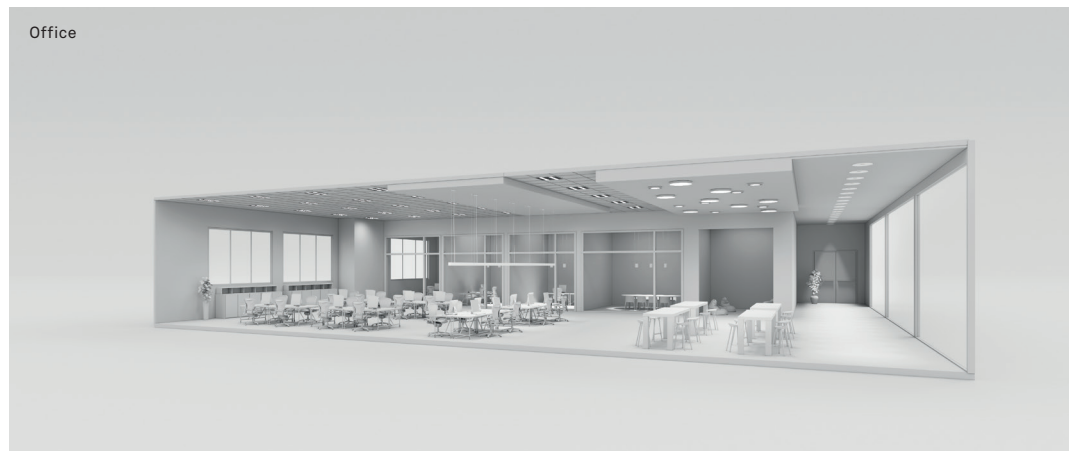

Technology

Light for Life



Casambi Solution



DALI2 Solution



D4i Solution



Air Conditioning Solution



Standalone Solutions



Light for Life

Lighting control solution based on wireless Bluetooth technology/wi-fi, depending on the type of product. It can be directly controlled from your smartphone using the app Light for Life — a fast and easy-to-use application. This system is compatible with all major voice assistants

There are three options to transform a light fitting into a connective one and control it via the App Light For Life:

- a) Standard dimmable light fixtures using DALI or 0-10V: add 0-10V - DALI dimming element.
- b) Lighting compatible with standard E27 or GU10 sockets: add a connective bulb with a compatible socket.
- c) Luminaires where it is possible to install the 0-10V - DALI dimmer device inside the light fixture, for example: Infinite or Luno.

Represented with:



Mobile app for programming

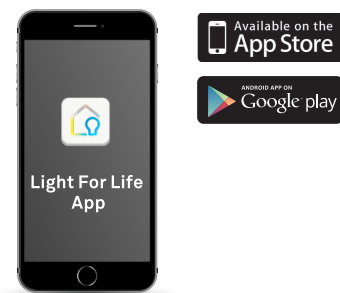

Solution's architecture

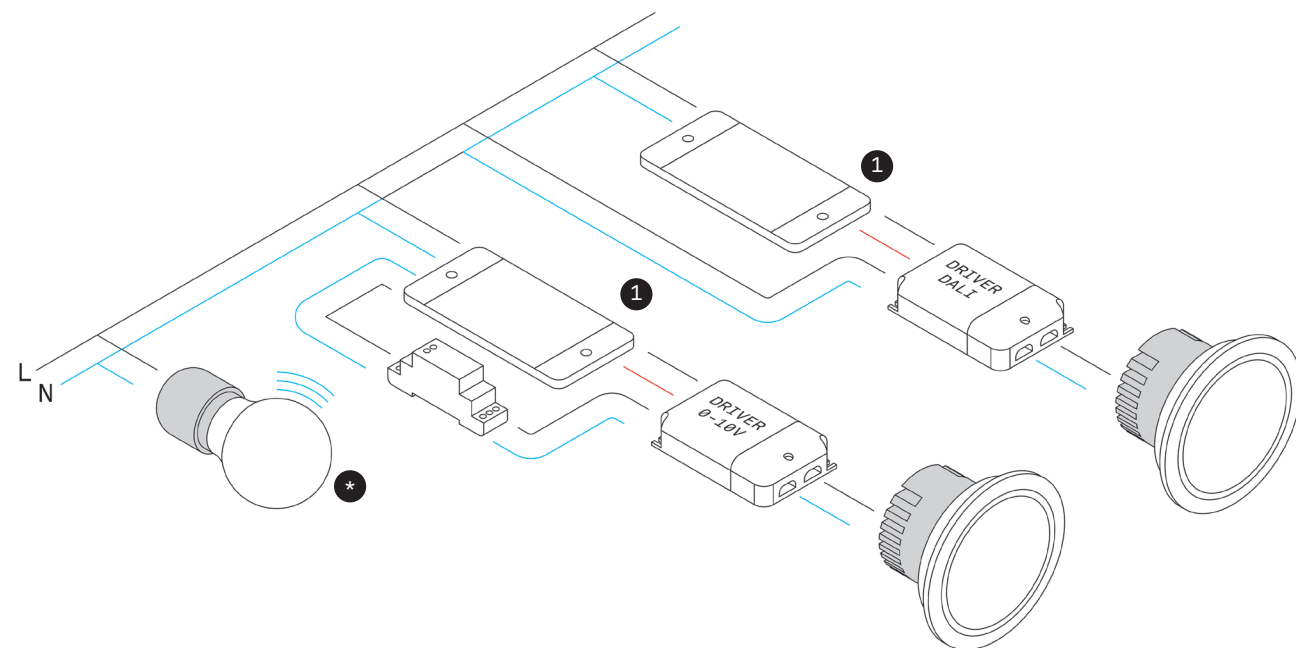

1 Controller 0/1-10V or DALI



71-8218

Device that allows you to incorporate any light with a 0/1-10V or DALI driver into Light for Life system.

Functions

Personalised control

Individually control the lights directly from a smartphone.

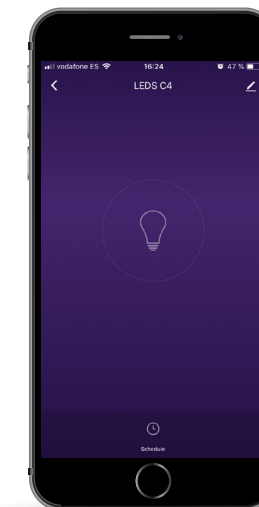

Colour/temperature control

Control the colour temperature and lights' RGB.



Scenes

Create scenes that set the mood at any given time.

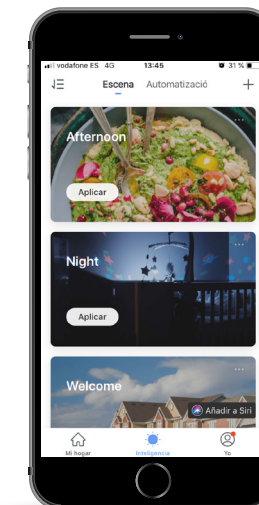

Hourly programmes

Timer for automatic activation.



Casambi Solution

Lighting control solution based on Bluetooth Mesh protocol with direct control from a Smartphone or Tablet, with no additional components required.

Scalable solution from one line to several lines with point-to-point or centralised control.

Solution's architecture

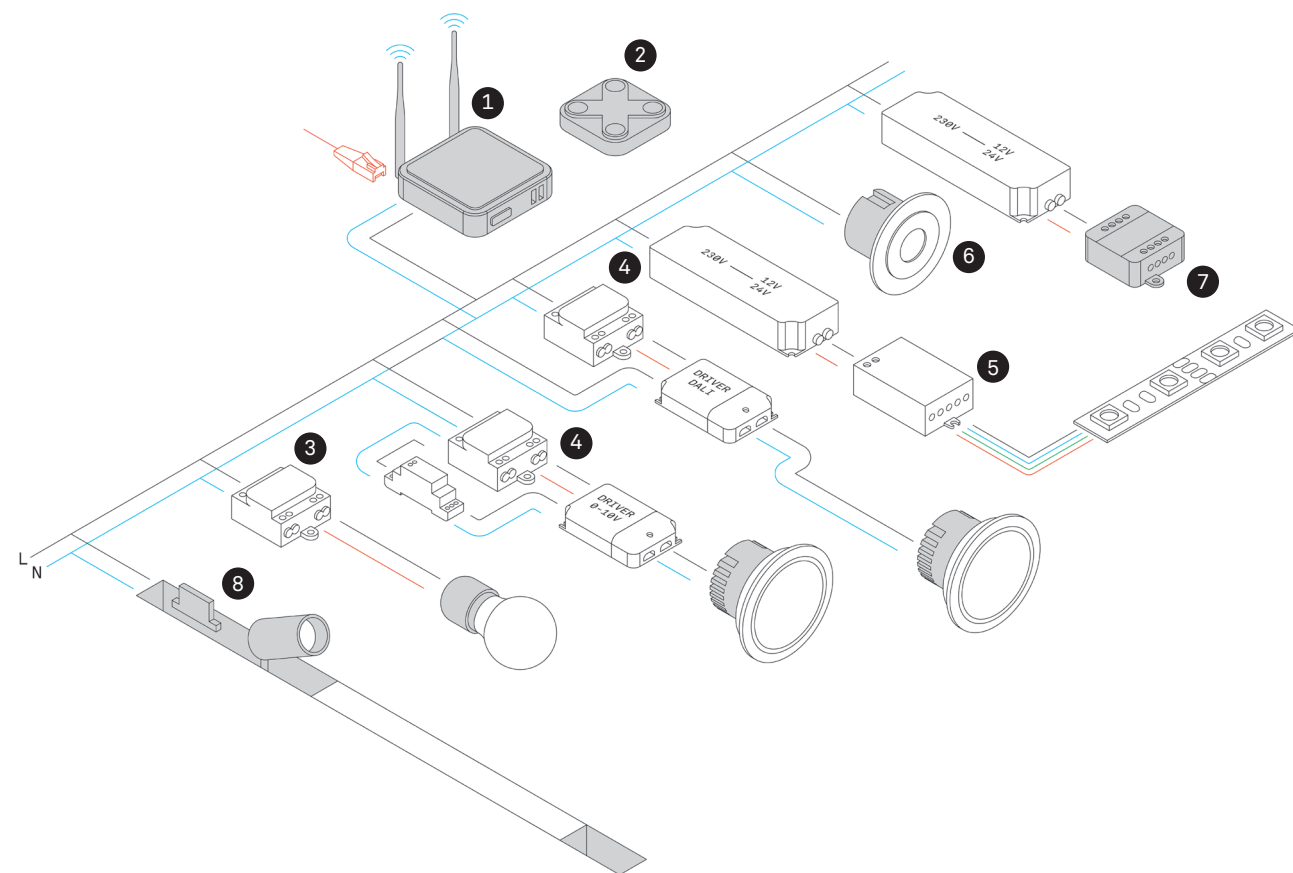

1 Gateway Bluetooth



71-8055

A converter that enables remote access to a Casambi installation. An HDMI connectable screen and a fixed Internet connection are required for remote access at any given time.

2 Bluetooth keypad



71-8053

It enables four functions such as individual luminaires, clusters, scenes or sequences to be switched on and off. With the + / - icon, you can adjust the brightness of each of the lights.

Use the icons < and > to change the colour temperature in luminaires with TW technology.

3 Bluetooth trailing edge dimmer



71-5959

Element to integrate a luminaire with trailing Edge regulation to the Bluetooth control system.

4 DALI Bluetooth 0-10V dimmer

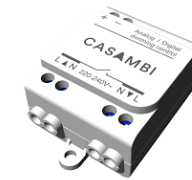

71-5961

Element to connect a luminaire with 0-10 or DALI equipment to the Bluetooth control system. Compatible with DALI DT8 TW type technology luminaires. Maximum of three luminaires per device.

5 4 ch. PWM Bluetooth dimmer



71-8050

Element to be fitted in a luminaire compatible with 12 or 24V PWM constant-voltage regulation, mainly RGB or TW (e.g. LED strips, Tron).

6 Bluetooth presence and brightness sensor



71-8049

A device that activates luminaires individually, in clusters or scenes, by detecting their presence and/or regulating their brightness value based on natural light input and or the circadian cycle.

7 Timer Bluetooth



71-8052

An element that includes an internal clock to keep time when there is no power. When the power is switched on again, it sends the time to all installation elements.

8 Track Low Voltage compatible DALI controller

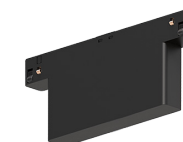

71-8115

It enables DALI regulation in the low-voltage rail solution. The lights must be dimmed using DALI protocol.

Casambi Solution

There are two ways of transforming a conventional luminaire into a connective luminaire, controlled via bluetooth:

a) Standard adjustable luminaires (DALI, 0-10 and trailing-edge phase cut): add ELT eBlue 0-10/DALI component or ELT eBlue trailing edge component.

b) Lighting fixtures that afford the installation of the ELT eBlue 0-10/DALI or ELT eBlue trailing edge device inside of the lamp itself. The catalogue features several product lines that can house these devices within the body of the lighting fixture, such as: Infinite, Exit, Pek, Bravo, Sugar and Caprice.

Those products are identified by:



Mobile app for programming



Functions

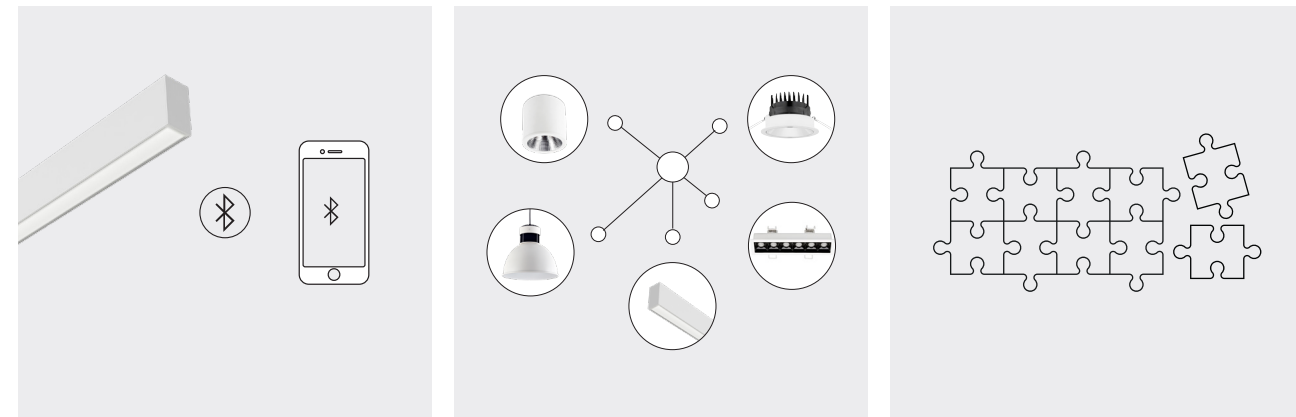

Bluetooth Low energy

A solution based on the Bluetooth technology used in smart phones and tablets. This allows for direct communication between luminaire/controller and mobile device, without the need to add any other physical elements.

Wireless Mesh Network

A scalable system that makes it possible to create a made-to-measure information network (nodes) which devices can be added to. The system intelligence is replicated in each node, meaning that if one node is removed, the rest of the system can still function.

With this mesh system and Bluetooth technology, an internet connection is not required for local control.

Casambi Ecosystem

The Casambi ecosystem ensures interoperability between different products like sensors and switches.

Individual control

On/off and point-to-point control.



Group

On/off and control of several luminaires at the same time.



Lighting scenes

On/off and control of several luminaires, each with an individual adjustment value.



Colour temperature control

Variation of colour temperature and brightness in luminaires with TW technology.

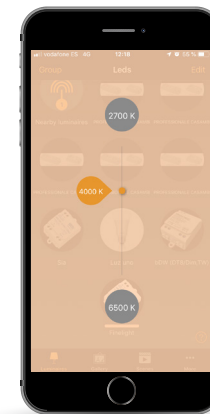

Gallery

Luminaires superimposed on an image to act directly on it.

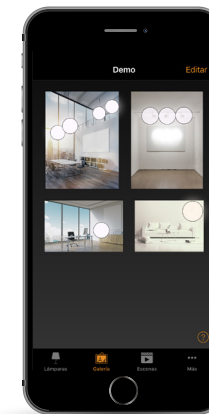

Calendar

Automatic activations of lighting scenes, based on a particular time.



Circadian cycle

Dimming of one or more luminaires based on the pre-defined or customised circadian cycle.

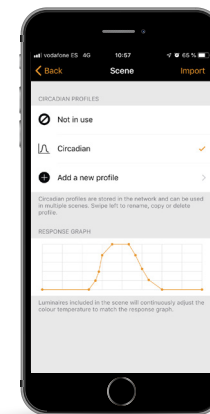

Constant light control feature

Automatic luminosity control for one or more luminaires based on the amount of natural light present.



DALI2 Solution

Lighting control solution based on the DALI2 standard (includes compatibility with DT8 drivers).

Solution's architecture

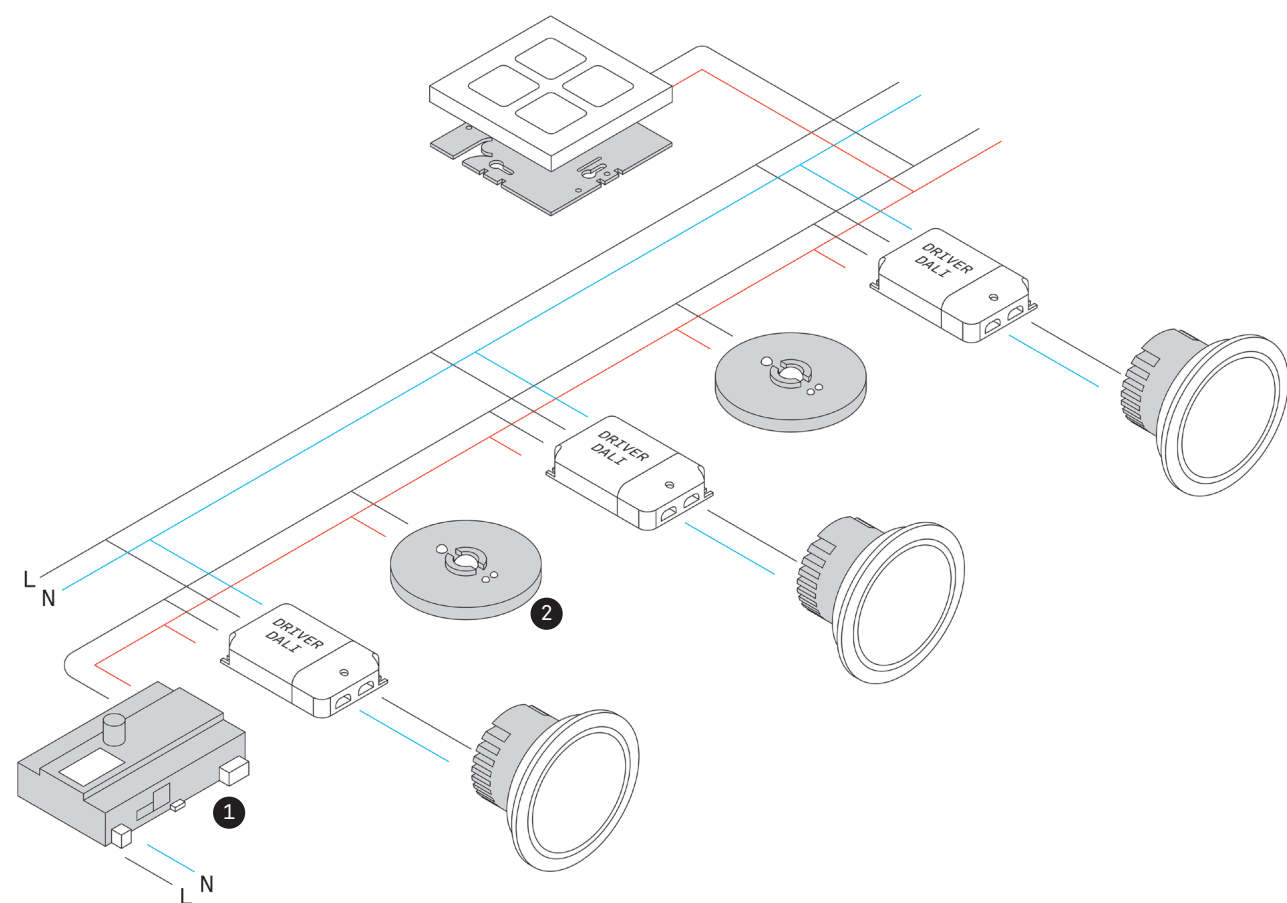

1 DALI2 Master Controller



71-8065

Device for controlling DALI luminaires and integrating DALI2 keypads, light and/or presence sensors. It can be integrated into a Building Management System (BMS) solution using standard protocols such as BACnet/IP^, Modbus TCP and OPC.

2 Multi-sensor for DALI2 system



71-8066

Presence and brightness sensor (brightness range from 0 to 1,000 lx) to be integrated in a DALI2 system. Programming is done on the DALI2 Master controller.

2 DALI2 coupler

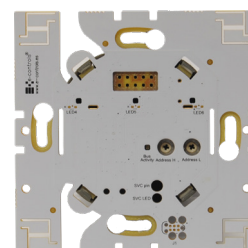

71-8068

The DALI2 Master coupler set with the front keypad makes it possible to program 4 to 9 personalised functions, such as switching on a luminaire, a set of lights, a scene, etc.

DALI2 front 4-function keypad



71-8070

Front DALI button compatible with DALI Master bus coupler that allows you to program 4 functions and customise your icons.

DALI2 front 9-function keypad

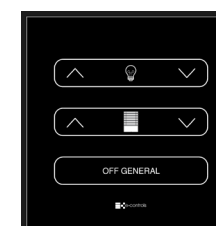

71-8071

Front DALI button compatible with DALI Master bus coupler that allows you to program 9 functions and customise your icons.

DALI2 Solution

Functions

In an installation, major energy savings can be achieved through features such as point-to-point lighting management, clusters, scenes, constant light control, circadian cycle, control by occupation and time schedules, among others.

It enables you to calculate the hours of operation and consumption of each luminaire, thus enabling proactive preventive maintenance. Fault alarms can be sent to an email.

Since the programming is personalised, the possibilities are unlimited.

Programming is done via on-site programming software or web server. Within this programming it is also possible to view the installation and luminaires on a map in an up-to-date and real-time manner.

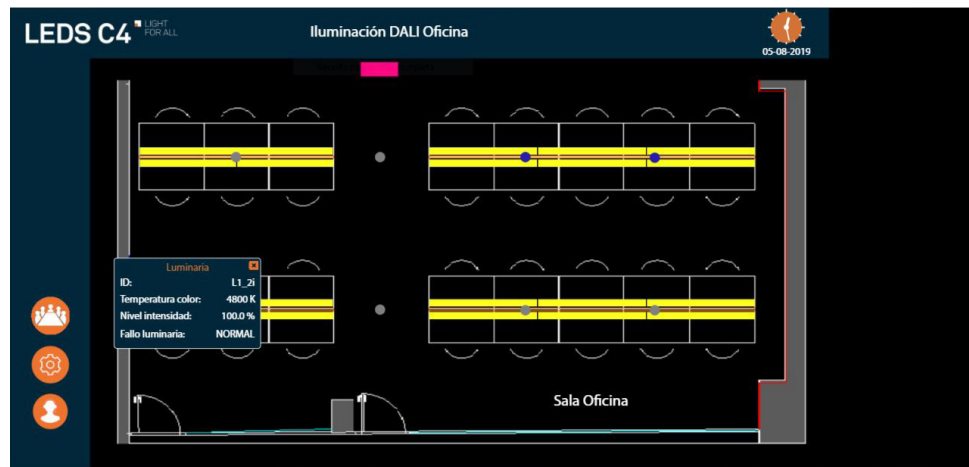

Real-time monitoring of the light fixtures and sensor status. Option to activate/deactivate lights locally and remotely.

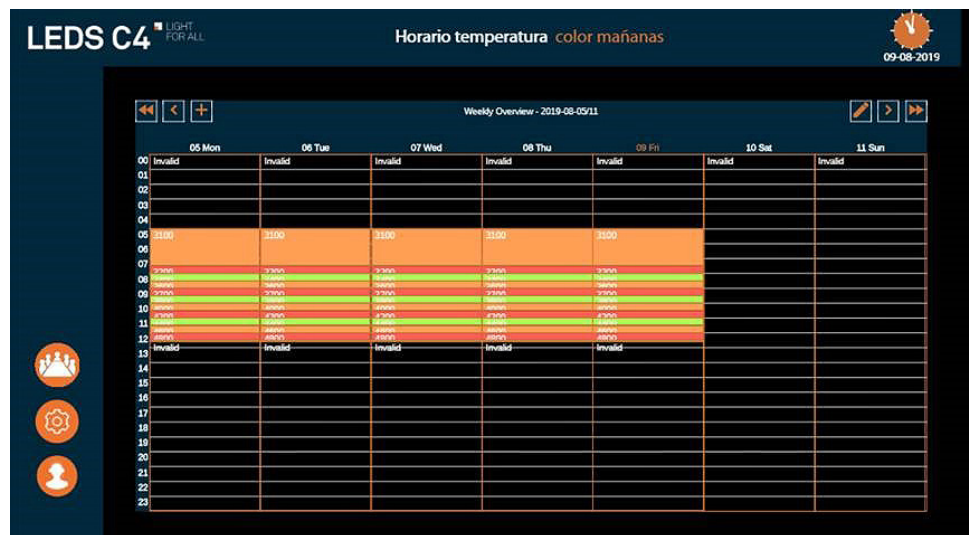

Personalised daily time schedules with different lighting scenes, light levels and time slots.

D4i Solution

Solution for lighting control and connectivity in a space.

Based on the standard D4i, means any driver with this technology is compatible with the platform.

In addition to providing control functionalities, it allows the system to be monitored through the platform and, thus, gather data on occupation and space use.

Solution's architecture

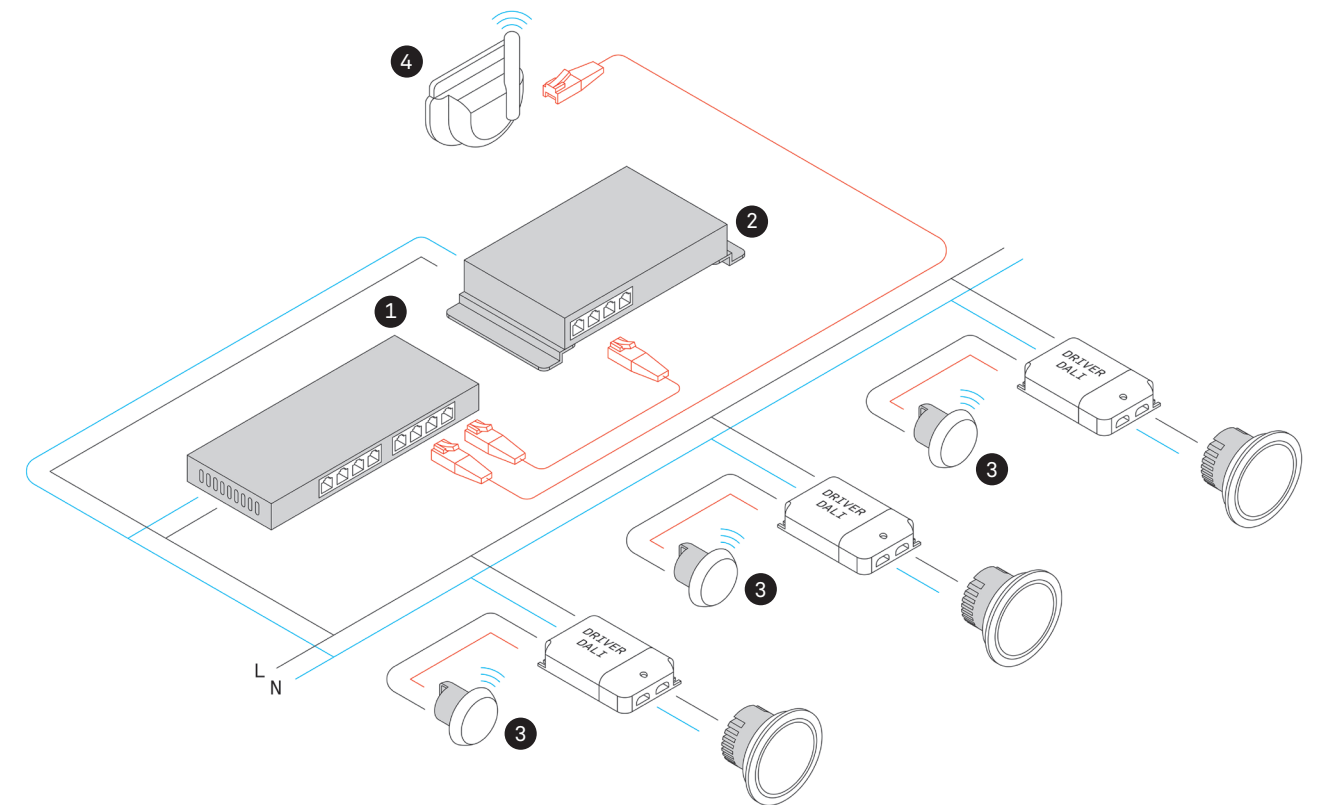

1 PoE Power Supply



71-8064

It feeds the required power to the D4i Platform Controller-Manager and Gateway Sensor via Power over Ethernet (PoE).

2 D4i Platform Controller-Manager



71-8063

A device that centralises data from all D4i sensors and control functions on a management platform. This platform handles lighting and stores energy consumption, temperature and occupancy data for later analysis.

3 Connective multi-sensor



71-8056

Presence, luminosity, temperature and occupancy sensor compatible with D4i technology drivers. Required accessory for ceiling (71-8058-00-00) or surface (71-8059-00-00) installation.

3 PRO Multisensor



71-8057 (Coming soon)

Besides connective multisensor functionalities, digital services can be accessed:

IoT Space: extended information on occupancy, space utilisation and movement flows.

IoT Where: Beacons & tracking of people and/or objects via Bluetooth.

4 Sensor Gateway



71-8061

A converter that lets you change information between the sensors' wireless communication protocol and the D4i Controller-Manager Platform.

5 Botonera conectiva



71-8062

A physical interface that lets you switch on/off and dim one or a whole set of luminaires.

71-8060 (Coming soon)

Used to update the firmware version of a multisensor connective to update to PRO.

D4i Solution

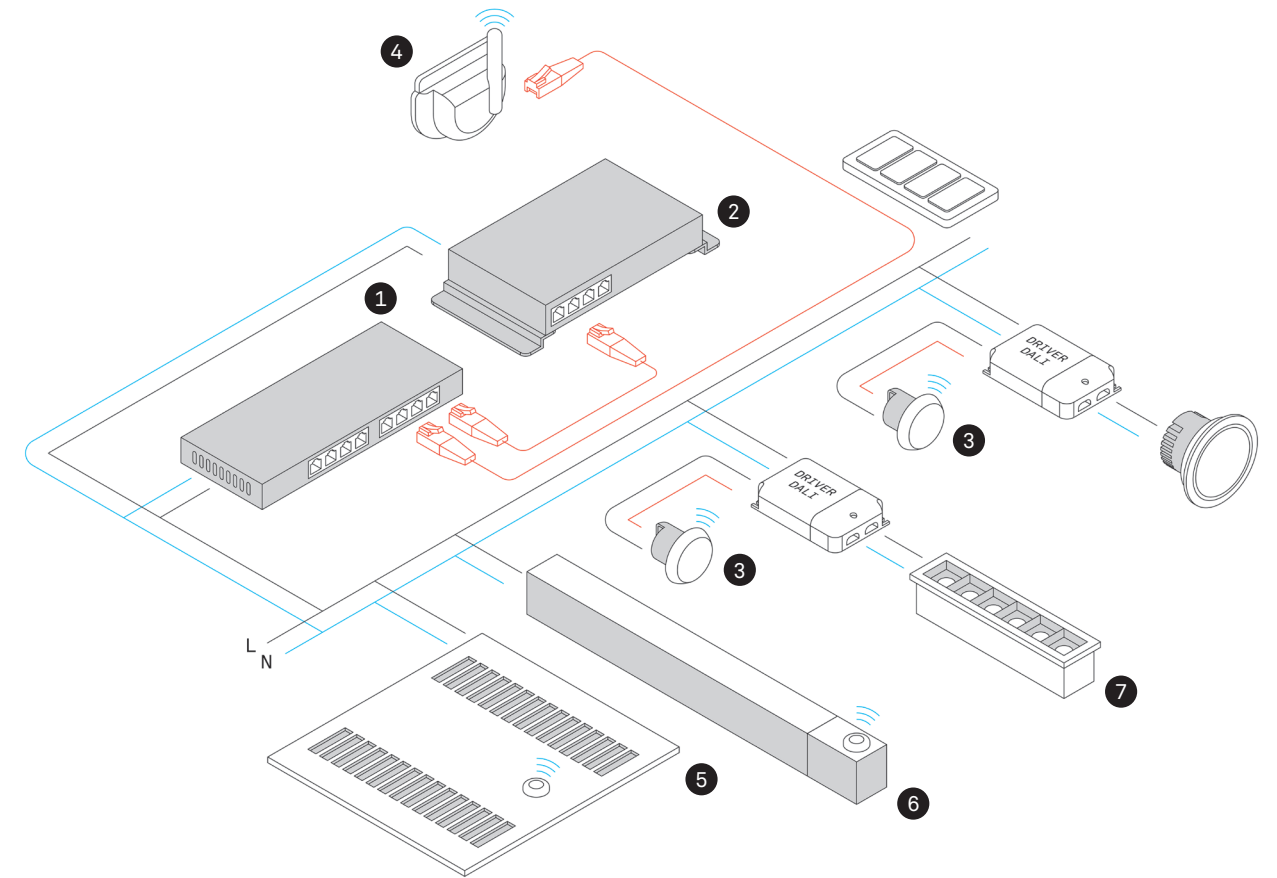

Compatible light fixtures with integrated sensor

<p>5 Finelight</p>	<p>6 Infinite PRO</p>	<p>7 Bento</p>	<p>8 Sia</p>
---------------------------	------------------------------	-----------------------	---------------------

Lighting with external sensors

Functions



Remote control.
Installation status.
Profile and group design.



Savings through natural light, occupation and task adjustment.
Energy reports adapted to the needs of each action carried out.
Real-time monitoring of the power consumed and saved.

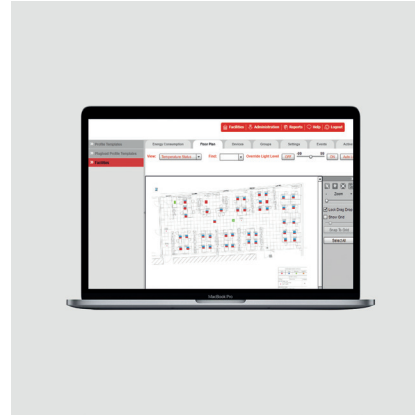

Information on ambient temperature and the luminaire to enable easy integration with air conditioning and heating systems.

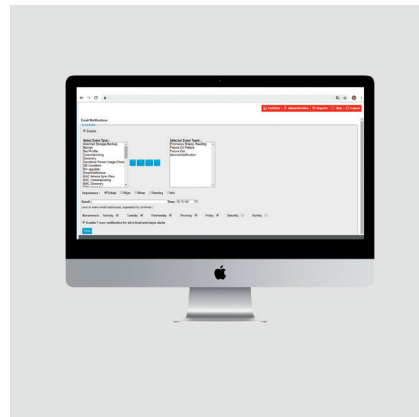

Alarm management.
Programmable e-mail notifications based on various parameters such as luminaire malfunction or overheating, available updates, ...



Heat map reports for proper space management and assessment.

Air-conditioning solution

An autonomous solution that lets you control a room's air conditioning. Through the "Lighting Module" device, lighting circuit control can be added to the solution easily.

Solution's architecture

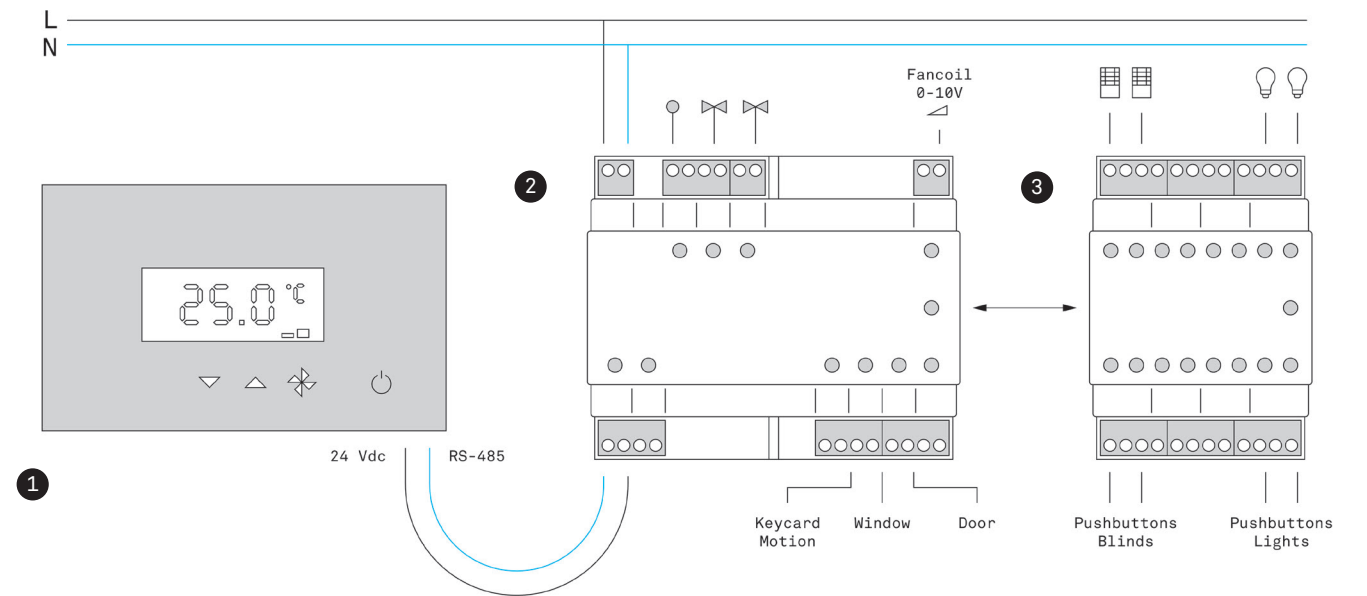

1 Air conditioning controller coupling

Front air conditioning controller

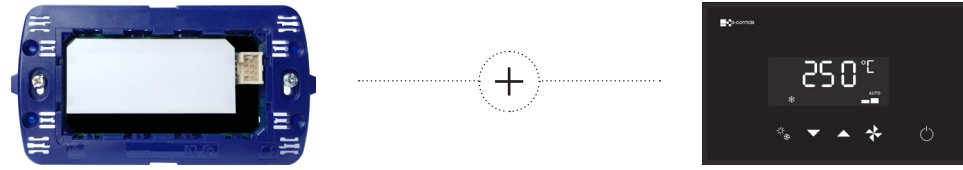

71-8073

Both the coupler assembly and the front of the air conditioning controller intuitively turn on, turn off or modify the temperature and speed of the air conditioning equipment through an easy-to-use interface.

71-8074

Front air conditioning controller compatible with air conditioning system coupler.

2 Autonomous air conditioning controller

3 Illumination module for air conditioning controller



71-8072

Device with inputs for key contact / motion detector, window contact, water probe / door contact and 0-10V analogue outputs (Fan-coil EC) and relays for hot/cold water solenoid valve.



71-8075

Autonomous device for lighting control and powered blinds.

It has 8 inputs for standard buttons and 8 voltage-free relay outputs.

Standalone Solutions

Standalone control solutions. These can be used to control one or more luminaires within the same space independently. With Standalone solutions, you can perform simple functions and save energy.

Solution's architecture

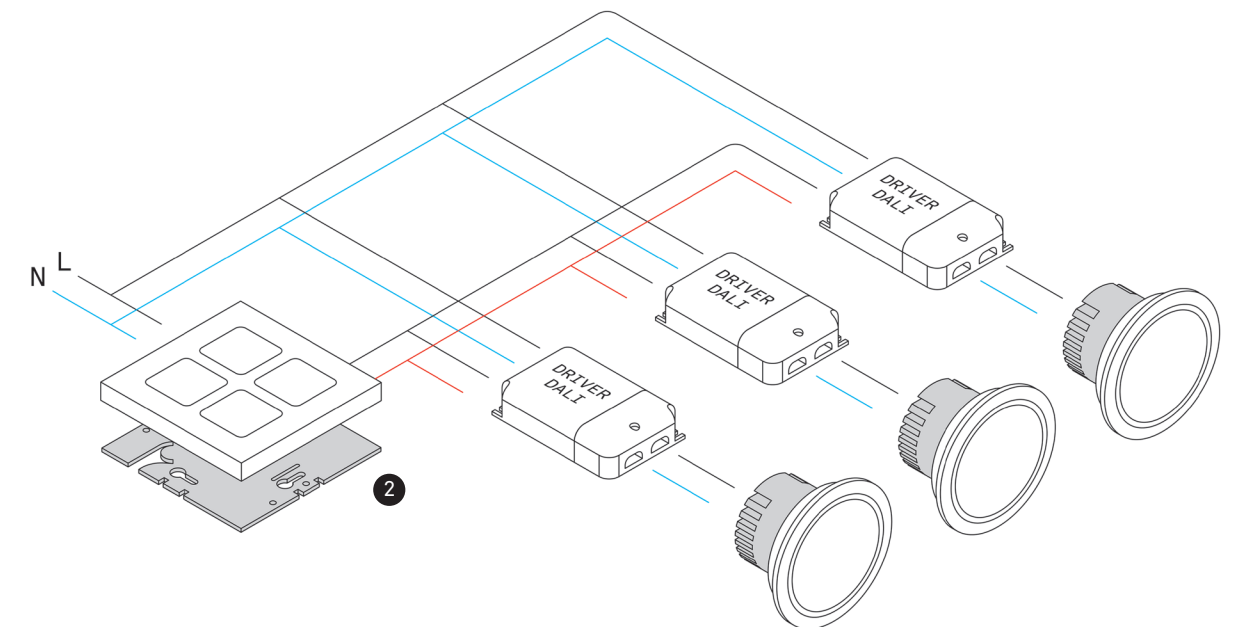
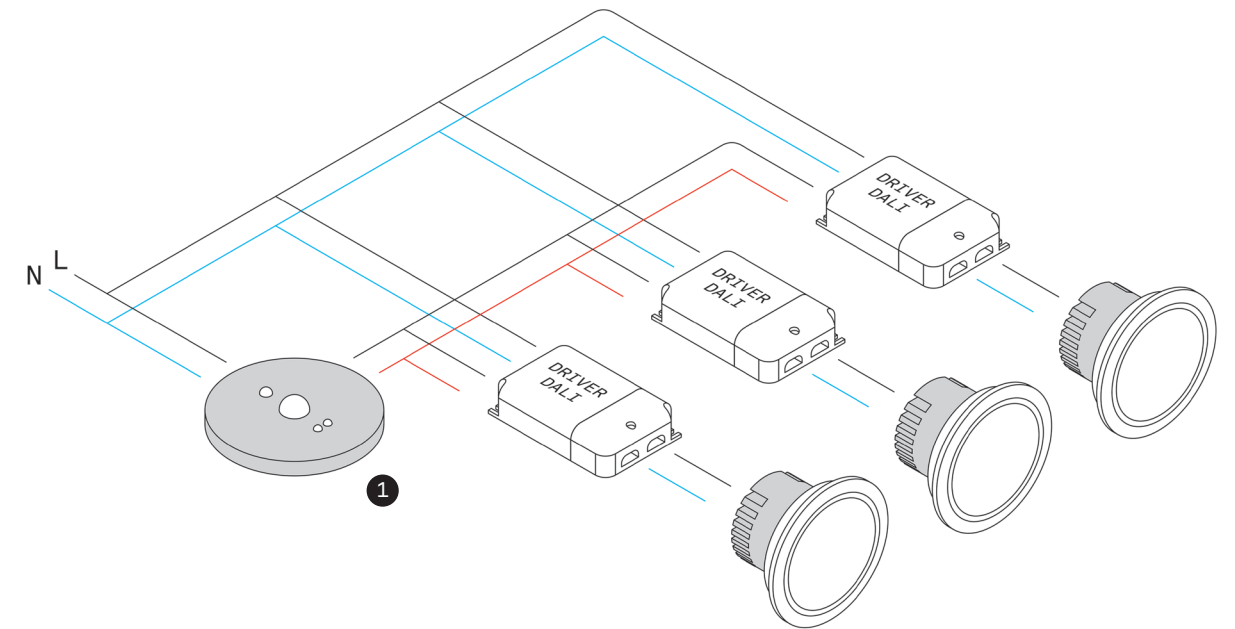

1 DALI Standalone multi-sensor



71-8067

Brightness and presence sensor lets you to switch on the lighting when a room is in use and maintain a constant level of light, depending on the amount of natural light.



2 DALI Master bus coupler

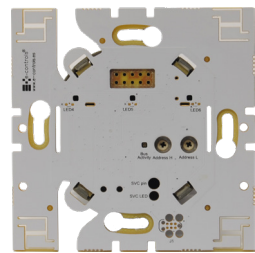

71-8069

The DALI Master coupler set with the front DALI keypad makes it possible to program personalised functions, such as switching on a luminaire, a set of lights, a scene, etc., via an app on your mobile device.



DALI front 4-function keypad



71-8070

Front DALI button compatible with DALI Master bus coupler that allows you to program 4 functions and customise your icons.

DALI front 9-function keypad

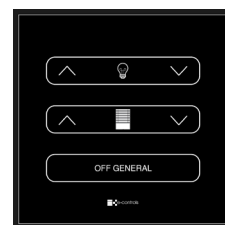

71-8071

Front DALI button compatible with DALI Master bus coupler that allows you to program 9 functions and customise your icons.



Standalone Solutions

Intuitive and easy-to-use user interfaces, with an attractive and minimalist design. Tactile technology enables precise and quick customisation to achieve the desired ambience.

DALI controller



71-7671

Adjusts the brightness of a row of luminaires using DALI protocol



DMX or PWM controllers

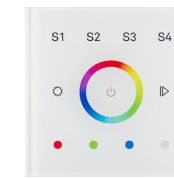

71-7666 (DMX) / 71-7664 (PWM)

Control buttons based on DMX or PWM protocols. Using one control pad, allows colour adjustment and memorisation of predefined static and dynamic settings.



DALI controller

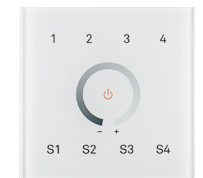

71-7665

Control buttons based on DALI technology.

Enables several DALI lines to be controlled (*prior set-up required) and memorisation of lighting scenes.



Examples of use

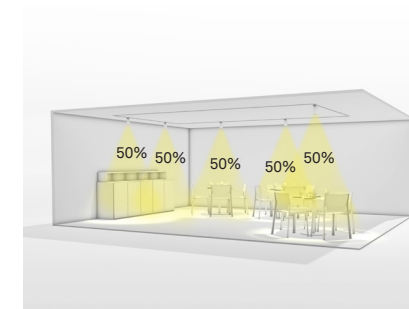

A high overall light level suggests a dynamic space with high footfall. In contrast, a low light level suggests a more private space.

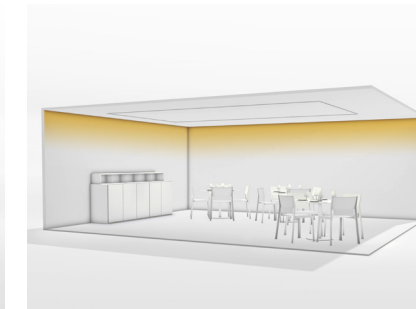

RGB lighting effects create sensations to suit the needs of each moment: transmitting a sense of dynamism or relaxation.

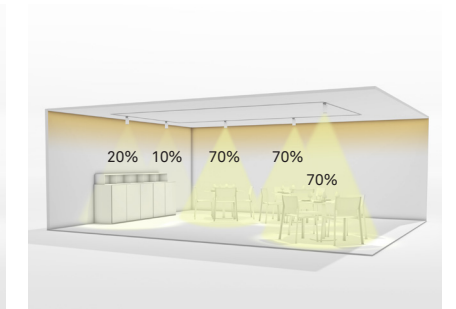

Settings with different lighting levels create the right atmosphere for each moment of the day: lunch (general light), evening meal (soft, focused lighting), etc.

Wireless controllers to adjust lighting from any point of the room. Fast interaction via switches and tactile control circuit. Includes a quick-mount support, fixed in place by support magnets.

White controller



71-7670 (Controller) / 71-7668 (Receptor)

Set of controller plus 1-channel receiver, compatible with PWM protocol. Can be used to control up to six independent lines, adjust brightness and memorise six lighting scenes.



RGB controller



71-7667 (Controller) / 71-7669 (Receptor)

Controller plus 4-channel receiver enables control of six independent colour lines and memorisation of six predefined static or dynamic lighting scenes.



Examples of use

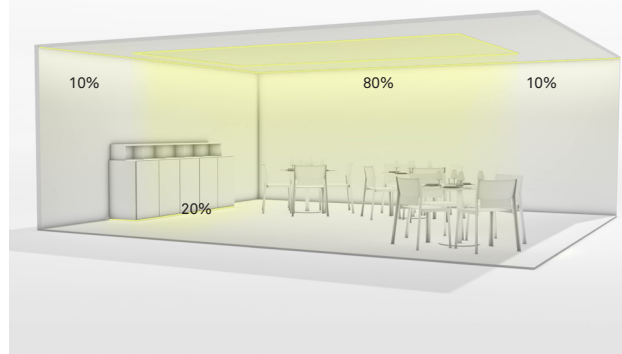

Lighting by zones allows different objects to be highlighted. Up to 6 zones can be included.

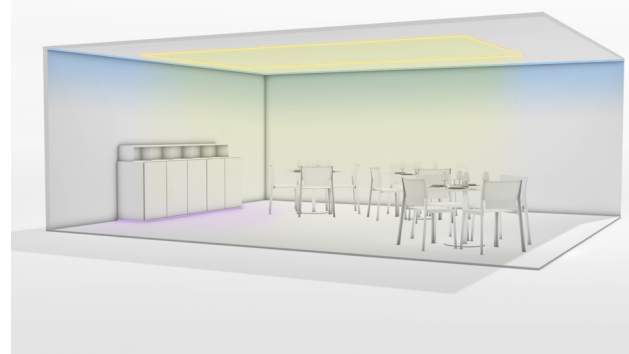

Different coloured lighting effects create a unique emotional atmosphere.

Standalone Solutions

System based on DMX protocol Control via RF control or switch. Integrated series memory. Automatically remembers the last program assigned, either a sequence or fixed colour.

RF master control



71-E069

Controller based on Easy+ technology. Assigns features to control predefined static and dynamic lighting scenes, which can be selected from an RF master control.



Slave



71-E070

Additional-use device, in the event of requiring further luminaires adjusted by Easy+ protocol. A Master is required to make it work.

Function selected using the master.

Master control switch



71-E011

Controller based on Easy+ technology. Can be used to select predefined static colours and dynamic lighting scenes through a switch on the device.

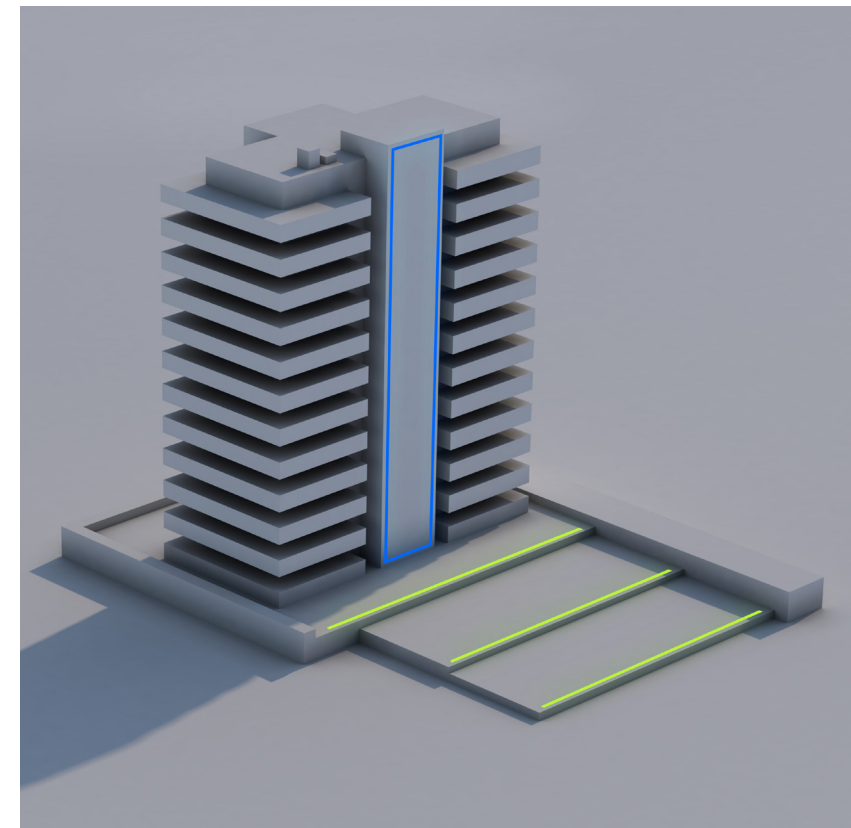

A soft RGB lighting effect in corporate colours can increase a building's visibility and also boost the brand image in technological terms.

