

monitillo<sub>1980</sub>

—  
BATH LINE

# BATH LINE

La creatività si fonde con la competenza, il design abbraccia l'arte della lavorazione delle pietre. Nasce così la prima collezione bagno firmata Monitillo 1980. Il materiale viene sapientemente lavorato, sia a mano che con macchinari evoluti, per diventare oggetto di uso quotidiano.

Eleganti, ricercati, curati nei minimi particolari, i prodotti della collezione Bath Line comprendono lavabi, piatti doccia, vasche, specchi e concept bagno.

Gli elementi possono essere scelti singolarmente o integrati in un sistema lineare personalizzabile. Una collezione dalla forte presenza scenografica, sviluppata utilizzando lavorazioni e sistemi innovativi di accoppiamento dei materiali

---

*The new Bath Line by Monitillo 1980: creativity merges with competence, design embraces the art of stone working. Marble is cleverly processed, both by hands and with cutting-edge technology, to become useful furniture for the daily life.*

*Elegant, exclusive and made with loving care for details the products of Bath Line include washbasins, shower trays, bathtubs, mirrors and integrated bathroom concepts.*

*The items can be used singularly or integrated in customizable bathroom concepts. The collection, with a strong scenographic impact, has been developed using innovative systems to match different materials.*

# INDICE

## INDEX

—	Vasche da bagno <i>Bathtubs</i>	10
—	Lavabi <i>Washbasins</i>	22
—	Piatti Doccia <i>Shower trays</i>	34
—	Specchi <i>Mirrors</i>	40
—	Concept bagno <i>Integrated bathroom concepts</i>	46

# MATERIALI

## MATERIALS

### MARMI - MARBLES



**Bianco Carrara**  
*White Carrara*

Il Bianco Carrara è da sempre uno dei prodotti marmorei italiani più ricercati e pregiati, che si distingue per il suo fascino e la sua eleganza  
*The most renown Italian marble for its elegance and brightness*



**Crema Imperiale**  
*Imperial Cream*

Il Crema Imperiale è una pietra italiana di origine metamorfica con fondo omogeneo di colore avorio  
*Refined stone from Italy with a light, uniform colour*



**Grigio Ambra**  
*Amber Gray*

Il Grigio Ambra è una pietra italiana con colorazione prevalentemente grigiastra e venature gialle  
*Hard Italian stone with a predominantly grey colour and yellowish veins*



**Ecrú Striato**  
*Striped Ecrú*

L'Ecrú Striato è una pietra calcarea italiana dalle particolari linee sinuose di colore beige e grigio chiaro  
*Italian limestone with sinuous lines in beige and grey*



**Verde Selva**  
*Forest Green*

Il Verde Selva è un marmo italiano dalle eleganti venature di colore bianco e grigio chiaro che attraversano il fondo verde intenso  
*Italian marble with white and light grey veins crossing the intense green colour of its background*



**Grigio Alpi**  
*Alps Gray*

Il Grigio Alpi è un marmo italiano dal colore di fondo grigio-blu caratterizzato da irregolari venature grigie e bianche  
*Italian marble featuring a grey-blue background and white, grey and yellowish veins*

### RESINE - RESINS

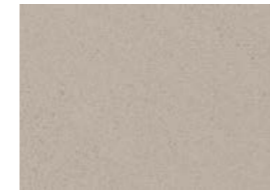

**Grigio Moresco**

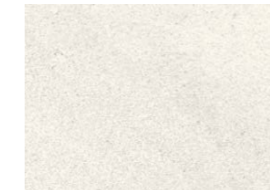

**Grigio Rena**

Finiture composte da miscela di cementi, minerali calibrati e resine di origine epossidica. I prodotti che compongono il ciclo non contengono sostanze solventi ma sono diluibili con acqua. Per maggiori dettagli tecnici su materiali, trattamenti e quotazioni della collezione, si prega di consultare le cartelle campioni e relativo listino.

*The different finishes are made of a mix of cement, calibrated minerals and epoxy resins that do not contain solvents and can be diluted with water. For more details on materials, treatments and pricing, refer to the sample folders and price list.*



#### VASCHE DA BAGNO *BATHTUBS*

Materiali eccellenti, linee esclusive e numerose combinazioni personalizzabili per una collezione di prodotti sofisticata ed estremamente curata nei particolari

*Refined materials, exclusive designs and customizable combinations characterize this sophisticated collection made with loving care for details.*





## MURA'

Una vasca rivestita interamente in marmo caratterizzata dalle forme minimali ed eleganti.

*Entirely covered with marble, Murà is a bathtub characterized by minimal and elegant shapes.*

### MATERIALI - MATERIALS



Bianco Carrara  
White Carrara



Ecrù Striato  
Striped Ecrù



Crema Imperiale  
Imperial Cream



Verde Selva  
Forest Green



Grigio Ambra  
Amber Gray



Grigio Alpi  
Alps Gray

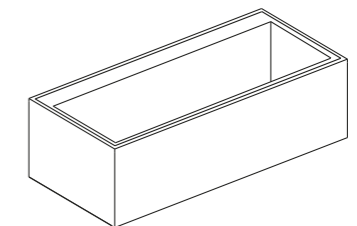

Cod. MO.VAS.LR1

L 185 cm  
P 85 cm  
H 52,5 cm

- A richiesta su misura -  
- Bacino medio 167x59 cm -

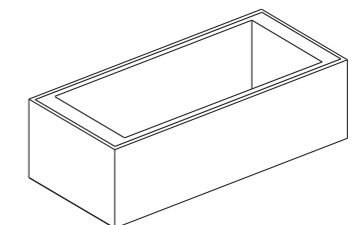

Cod. MO.VAS.LR2

L 185 cm  
P 85 cm  
H 52,5 cm

- A richiesta su misura -  
- Bacino medio 151x67 cm -



## APULIA

Esclusiva vasca monolitica ottenuta dalla paziente lavorazione di un singolo blocco di materiale. Ogni pezzo è unico ed esalta le peculiarità della pietra

*Exclusive bathtub made through the patient carving of a single stone block. Each bathtub is unique and enhances the uniqueness of natural stone.*

### MATERIALI - MATERIALS



Bianco Carrara  
White Carrara



Crema Imperiale  
Imperial Cream

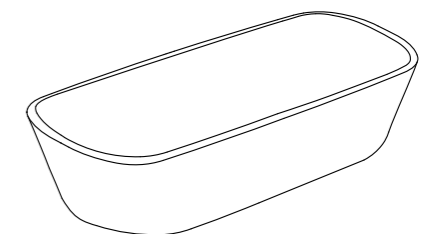

Cod. MO.APULIA

L 175 cm  
P 80 cm  
H 50 cm





## MATEOLA

Vasca sottopiano disponibile con bacino ovale o rettangolare in acrilico di alta qualità con rivestimento esterno in marmo disponibile in diverse combinazioni.

*Mateola is an undermount bathtub with an oval or round basin made of high quality acrylic and externally covered with marble - different combinations available.*

### MATERIALI - MATERIALS



**Bianco Carrara**  
White Carrara



**Crema Imperiale**  
Imperial Cream



**Grigio Ambra**  
Amber Gray



**Ecrù Striato**  
Striped Ecrù



**Verde Selva**  
Forest Green



**Grigio Alpi**  
Alps Gray

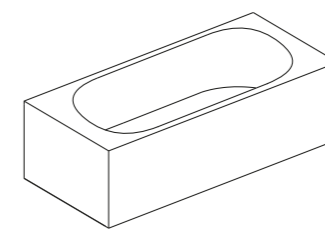

**Cod. MO.VAS.ECL**

L 185 cm  
P 85 cm  
H 52,5 cm

- A richiesta su misura -  
- Bacino 158x58 cm -

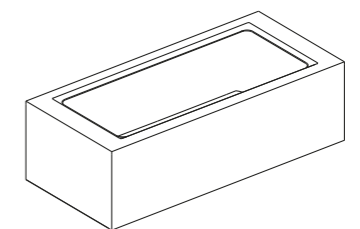

**Cod. MO.VAS.WAV**

L 185 cm  
P 85 cm  
H 52,5 cm

- A richiesta su misura -  
- Bacino 158x58 cm -

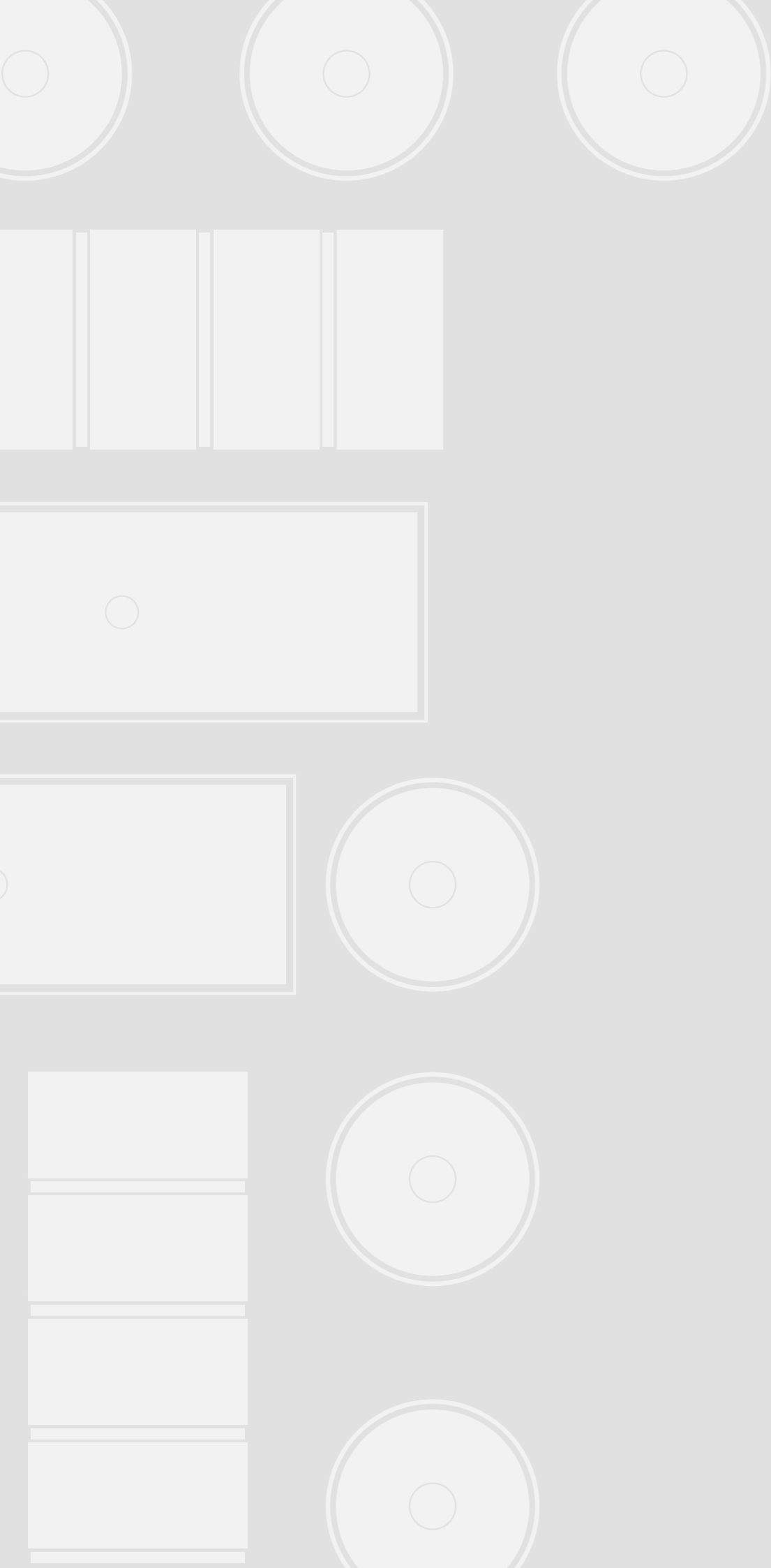

### LAVABI WASHBASINS

I lavabi della collezione bath line comprendono modelli da terra, in appoggio e sospesi, lavorati da blocco o rifiniti con resine speciali. Soluzioni diverse accomunate dall'elevata qualità e dall'eleganza di materiali e finiture

*The washbasins of Bath Line are freestanding, suspended or vanity-top, carved out of stone blocks or finished with special resins: different options all in elegant materials and finishes.*





## TRULLO

Lavabo freestanding da terra realizzati da 4 anelli sovrapponibili completamente in marmo e ricavati da un unico masso con piletta abbinata e senza troppopieno.

*Trullo is a free-standing washbasin made with four, stacked rings of marble carved out of a single block, with a matching drain and without overflow.*

### MATERIALI - MATERIALS



Bianco Carrara  
White Carrara



Crema Imperiale  
Imperial Cream

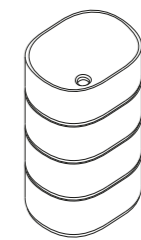

Cod. MO5040\_OV

L 50 cm  
P 40 cm  
H 85 cm

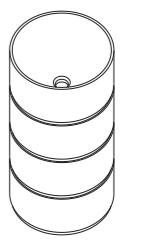

Cod. MOLA.D40

L 40 cm  
P 40 cm  
H 85 cm





## ITRIA

Lavabo tondo da appoggio soprapiano realizzato completamente in marmo da un unico masso. Disponibile con superficie levigata o nella finitura "Parallelo" della collezione Walls&Floors di Monitillo1980, con piletta abbinata e senza troppopieno

*ITRIA is a vanity-top sink made out of a single block of marble. Available with honed finish or in the "Parallelo" texture of Monitillo1980's collection Walls&Floors, with matching drain and without overflow*

### MATERIALI - MATERIALS



**Bianco Carrara**  
White Carrara



**Ecrù Striato**  
Striped Ecrù



**Crema Imperiale**  
Imperial Cream



**Verde Selva**  
Forest Green



**Grigio Ambra**  
Amber Gray



**Grigio Alpi**  
Alps Gray

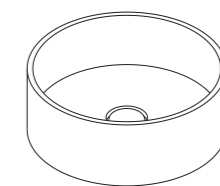

**Cod. MOLVB.D35**

L 35 cm  
P 35 cm  
H 13 cm

- A richiesta su misura -

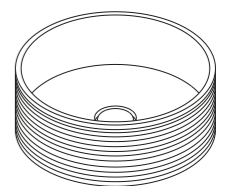

**Cod. MOLVB.D35P**

L 35 cm  
P 35 cm  
H 13 cm

- A richiesta su misura -





## DAUNIA

Lavabo sospeso con trattamento in resina privo di giunzioni, piletta ispezionabile centrale abbinata alla finitura del lavabo e senza troppopieno.

*Daunia is a suspended, jointless washbasin with resin-finish. It comes with an inspectable drain and no overflow.*

### MATERIALI - MATERIALS



Grigio Rena  
White Carrara



Grigio Moresco  
Imperial Cream

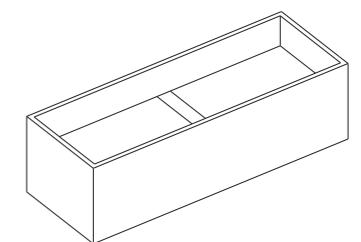

Cod. MO.LA.BRID

L 120/180/300 cm  
P 42,5 cm  
H 35 cm

- A richiesta su misura -



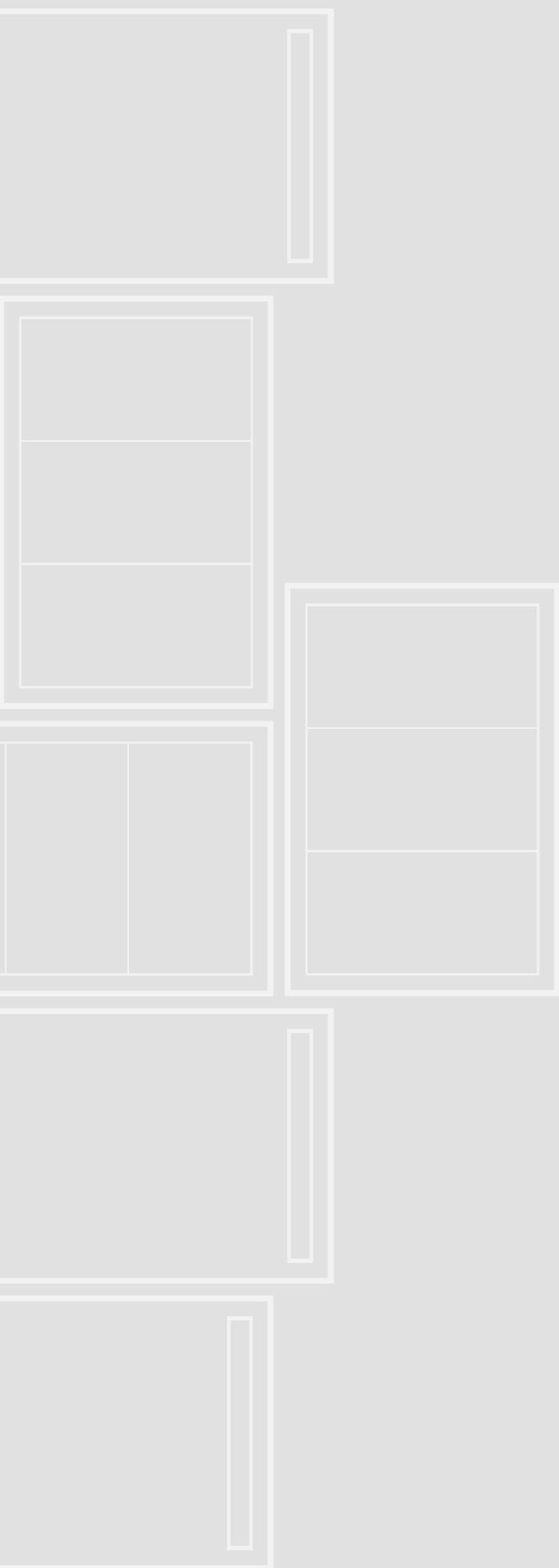

#### PIATTI DOCCIA *SHOWER TRAYS*

Piatti doccia interamente realizzati in marmo, disponibili in diverse misure e realizzabili a disegno. Prodotti eleganti, lineari e ricercati, compatibili con installazione a filo pavimento o in appoggio.

*Shower trays made entirely in marble, available in different sizes and customizable. Elegant, linear and refined - they can be installed floorflush or floorstanding.*





## MESSAPIA

Piatto doccia ispezionabile, realizzato interamente in marmo con piletta di scarico centrale non a vista. Presenta pedane removibili con superficie lavorata con texture PARALLELO della collezione Monitillo1980 Walls&Floors. Può essere installato in appoggio o a filo pavimento.

*MESSAPIA is a shower tray with access panel for inspection. Made entirely in marble, it comes with a non-visible, central drain. The footboard comes with the "Parallelo" texture of Monitillo1980's collection Walls&Floors. It can be installed floorflush or free-standing.*

### MATERIALI - MATERIALS



**Bianco Carrara**  
White Carrara



**Crema Imperiale**  
Imperial Cream



**Grigio Ambra**  
Amber Gray



**Ecrù Striato**  
Striped Ecrù



**Verde Selva**  
Forest Green



**Grigio Alpi**  
Alps Gray

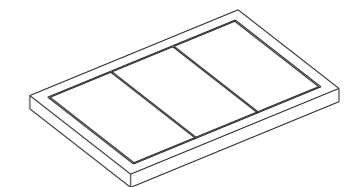

**Cod. MO.PD.STE.FU**

L 90 - P 110 cm (2 pedane)  
L 150 - P 110 cm (3 pedane)  
L 200 - P 110 cm (5 pedane)

- A richiesta su misura -

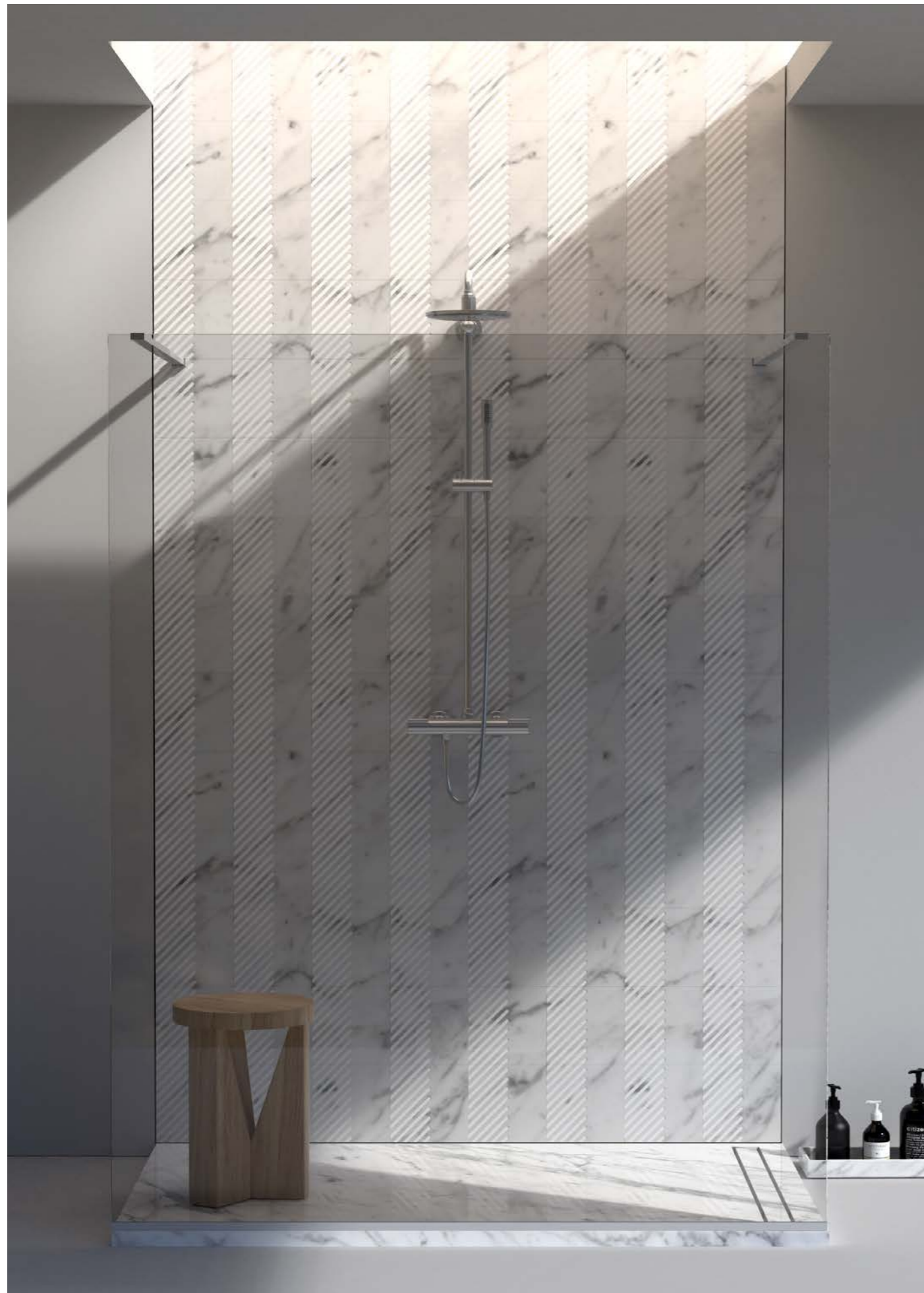

## TARAS

Piatto doccia disponibile in tre differenti misure.  
Presenta scarico asimmetrico integrato e pendenza  
per lo scolo dell'acqua.  
Può essere installato in appoggio o a filo pavimento

*Taras is a shower tray available in three different sizes.  
It features a lateral drain as well as an integrated slope.  
It can be installed floorflush or free-standing.*

### MATERIALI - MATERIALS

- |                                 |                                   |                            |
|---------------------------------|-----------------------------------|----------------------------|
| ○                               | ●                                 | ●                          |
| Bianco Carrara<br>White Carrara | Crema Imperiale<br>Imperial Cream | Grigio Ambra<br>Amber Gray |
| ●                               | ●                                 | ●                          |
| Ecrù Striato<br>Striped Ecrù    | Verde Selva<br>Forest Green       | Grigio Alpi<br>Alps Gray   |

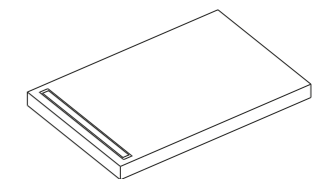

Cod. MO.PD.UNIPL

L 120 - P 80 cm  
L 160 - P 100 cm  
L 200 - P 120 cm

- A richiesta su misura -



### SPECCHI MIRRORS

Prodotti funzionali, dalle linee semplici e geometriche, in grado di adattarsi ad ogni ambiente e in sintonia con la collezione bath line con luce integrata oppure retroilluminati

*Functional, with simple and geometric lines – these mirrors can adapt to every setting and are in harmony with the other products of Bath Line.  
Backlit or with integrated light*



### SPECCHIERE MIRRORS

Serie di specchiere da piano o da parete,  
con luce e interruttore integrati

*Counter-top or wall mirrors, the switch and the  
light are integrated.*

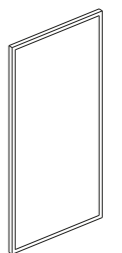
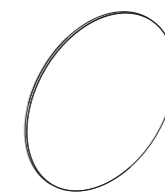

**Cod. MO.SPE.D90**

L 90 cm  
P 5 cm  
H 90 cm

- A richiesta su misura -

**Cod. MO.SPE.120.60**

L 120 cm  
P 5 cm  
H 60 cm

- A richiesta su misura -



#### CONCEPT BAGNO *INTEGRATED BATHROOM CONCEPTS*

Sistemi funzionali che esaltano la combinazione tra i prodotti della collezione bath line, disponibili in tutte le finiture a catalogo o personalizzabili. Possono essere posizionati a parete o ad isola con scarico laterale o a pavimento.

*The customizable, integrated bathroom concepts combine the products of Bath Line and are available in all the finishes of the collection. They can be wall mounted or free-standing with lateral or invisible drains*







### CONCEPT VASCA *BATHTUB CONCEPT*

Concept integrato comprensivo di mobile con cassetto, vassoio, lavabo soprapiano in appoggio e specchio con cornice in metallo.  
Abbinato a vasca con bacino ovale o rettangolare

*Integrated concept featuring furniture with a drawer, a console, a vanity-top sink and a mirror with metal frame to be combined with a bathtub with oval or rectangular base.*

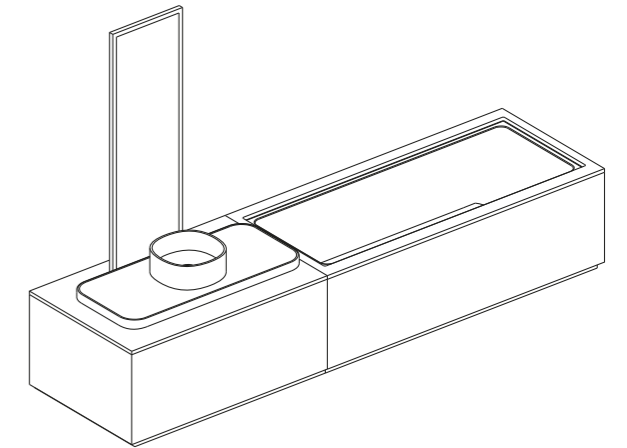

Cod. **MO.SIST.FULL**

L 305 cm  
P 85 cm  
H 63 cm  
- A richiesta su misura -



### CONCEPT LAVABO *VANITY-TOP CONCEPT*

Concept integrato comprensivo di mobile con cassetto, vassoio, lavabo soprapiano in appoggio e specchio con cornice in metallo.

*Integrated concept with furniture with a drawer, a console, a vanity-top sink and a mirror with metal frame.*

#### MATERIALI - MATERIALS

- |  |  |                                   |
|--|--|-----------------------------------|
| ○                                      | ●  | ●                                 |
| Bianco Carrara<br><i>White Carrara</i> | Crema Imperiale<br><i>Imperial Cream</i> | Grigio Ambra<br><i>Amber Gray</i> |
| ●                                      | ●  | ●                                 |
| Ecrù Striato<br><i>Striped Ecrù</i>    | Verde Selva<br><i>Forest Green</i>       | Grigio Alpi<br><i>Alps Gray</i>   |

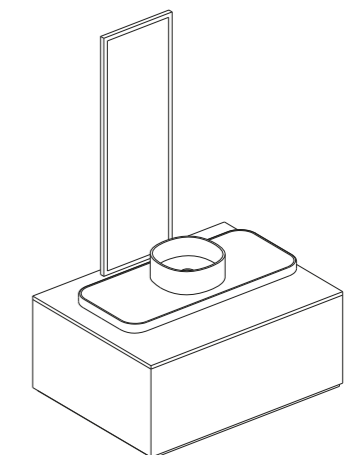

Cod. **MO.SIST**

L 125 cm  
P 85 cm  
H 63 cm  
- A richiesta su misura -

Nel presente catalogo sono inseriti alcuni prodotti della collezione **Pietre di Monitillo**  
*This catalog features products from **Pietre di Monitillo** collection*  
**[www.pietredimonitillo.com](http://www.pietredimonitillo.com)**

Monitillo Marmi Srl nell'ambito della normativa tecnica adottata, si riserva il diritto di apportare (in ogni momento e senza obbligo di preavviso) tutte le modifiche che, a proprio insindacabile giudizio, ritenesse opportune a migliorare la funzionalità e le prestazioni dei prodotti, nonché per rispondere a proprie esigenze tecniche e produttive.

*Within the framework of the adopted technical standards, Monitillo Marmi Srl reserves the right to make all those changes (at any time and without prior notice) that, in its final judgements, are needed to improve the functions and performances of the products, as well as to meet the company's technical and production requirements*

Monitillo Marmi s.r.l.  
Via Matera, Km 2  
70022 Altamura (Ba)  
tel. +39 080 3112325

[info@monitillomarmi.it](mailto:info@monitillomarmi.it)  
[www.monitillomarmi.it](http://www.monitillomarmi.it)