



CASAMANIA
HORM

Contenitori, Mensole e Librerie

Awards



2008 / Stand Salone 2005
2004 / Ripples
1998 / Istruzioni di montaggio



2016 / Autoreggente
2011 / Bek
2008 / Tide

2001 / Sottiletto
1998 / Wow! Plus
1998 / Take

1994 / Tola



2014 / Autoreggente
2013 / Infinity
2011 / RememberMe

2008 / N7



2014 / Toshi
2013 / Lepel
2013 / Chariot



2016 / QuaDror™ 03



2012 / Maritime



2016 / Tout le Jour



2016 / Torii



2010 / Lieve
2007 / A/R



2016 / Torii
2015 / Autoreggente
2013 / Chariot
2011 / Sinapsi

2008 / Bek
2008 / A/R
2007 / Blend
2007 / Tide

2006 / Stand Salone 2005
2004 / Ripples
1999 / Sottiletto

Home & Contract

Gli opposti si attraggono. HORM e CASAMANIA hanno da sempre due anime distinte, intrise di pura passione per la ricerca, la qualità, il design. Questo Catalogo rappresenta l'inizio di un progetto: far dialogare questi pluridecennali campioni del Made in Italy, nel solco della loro identità. Horm è lo stile più rigoroso, formale, elegante, caratterizzato dal sapiente uso delle materie pure come il legno, la pietra, il marmo, il vetro. Casamania gioca da sempre con l'ironia, l'irriverenza formale, la voglia di rompere gli schemi nel segno della funzionalità e della ricerca. La prima è sempre stata e continuerà ad essere un'icona di stile e di raffinata eleganza in ambito HOME; la seconda è un modello per il mercato CONTRACT. Tuttavia gli opposti si attraggono, si fondono e si moltiplicano, offrendo infinite soluzioni di stile, di utilizzo, di collocazione. Due identità che unite vogliono rompere le rigide barriere del mercato, ponendo al centro del progetto l'Uomo nelle sue molteplici attività: pensare, sedersi, riposare, mangiare, lavorare, studiare, giocare, dormire, amare, sognare, conversare. Horm e Casamania: Home & Contract.

Vol. 01
Sedute, Tavoli e Tavolini

Vol. 02
Contenitori, Mensole e Librerie

Vol. 03
Complementi, Illuminazione e Outdoor

Vol. 04
Letti, Divani Letto e Isole Figi

Vol. 05
Divani

Opposites attract. HORM and CASAMANIA have always had two different souls, imbued with a pure passion for research, quality and design. This catalogue represents the starting point of a new project: to make these historical champions of the Made in Italy production talk to each other, in the wake of their identity. Horm is the most rigorous, formal, elegant style, characterised by the skilful use of pure materials, such as wood, stone, marble and glass. Casamania has always played with irony, formal irreverence, the desire to break the mould in the name of functionality and research. The first has always been and will continue being an icon of style and refined elegance in the HOME, the second a model for the CONTRACT market. However, opposites attract, merge and multiply, offering infinite solutions of style, use and arrangement. Two identities that together want to break the rigid barriers of the market, placing People in its many activities at the heart of the project: thinking, sitting, resting, eating, working, studying, playing, sleeping, loving, dreaming, talking. Horm and Casamania: Home & Contract.

Vol. 01
Chairs, Tables, and Low Tables

Vol. 02
Storage and Shelving Solutions

Vol. 03
Furnishing Accessories,
Lighting, and Outdoor

Vol. 04
Beds, Sofa Beds, and Figi Islands

Vol. 05
Sofas and Armchairs

Les opposés s'attirent. HORM et CASAMANIA ont toujours eu deux âmes distinctes, imprégnées d'une pure passion pour la recherche, la qualité et le design. Ce catalogue représente le début d'un projet: faire dialoguer ces pluridécennales champions du Made in Italy, dans la lignée de leur identité. Horm représente un style plus rigoureux, formel, élégant, caractérisé par une utilisation habile des matériaux purs comme le bois, la pierre, le marbre et le verre. Casamania a toujours joué avec l'ironie, l'irrévérence formelle, le désir de briser les schémas sous le signe de la fonctionnalité et de la recherche. La première a toujours été et continuera à être une icône de style et d'élégance raffinée dans le domaine HOME, la seconde est un modèle pour le marché CONTRACT. Cependant, les opposés s'attirent, fusionnent et se multiplient, en offrant des solutions infinies de style, d'utilisation et d'emplacement. Deux identités qui, ensemble, veulent briser les rigides barrières du marché, en plaçant l'Homme dans ses nombreuses activités au centre du projet: penser, s'asseoir, se reposer, manger, travailler, étudier, jouer, dormir, aimer, rêver, converser. Horm et Casamania: Home & Contract.

Vol. 01
Chaises, Tables et Tables Basses

Vol. 02
Meubles de rangement, Etagères et Bibliothèques

Vol. 03
Compléments d'ameublement,
Luminaire et Outdoor

Vol. 04
Lits, Canapés-lits et Îles Figi

Vol. 05
Canapés et Fauteuils

Gegensätze ziehen sich an. HORM und CASAMANIA hatten schon immer zwei verschiedene Seelen, durchdrungen von einer reinen Leidenschaft für Forschung, Qualität und Design. Dieser Katalog stellt den Beginn eines Projekts dar: diese jahrzehntelangen Meister des Made in Italy im Zuge ihrer Identität miteinander in Dialog zu bringen. Horm ist der rigoroseste, formalste und eleganteste Stil, der sich durch den geschickten Einsatz von reinen Materialien wie Holz, Stein, Marmor und Glas auszeichnet. Casamania setzte schon immer auf Ironie, formale Respektlosigkeit und den Wunsch, diese Klischees im Namen der Funktionalität und Forschung durchzubrechen. Die erste war und ist eine Ikone des Stils und der raffinierten Eleganz im Bereich HOME, die zweite ein Modell für den CONTRACT-Markt. Gegensätze ziehen sich jedoch an, verschmelzen und multiplizieren sich und bieten unendliche Lösungen für Stil, Nutzung und Anordnung. Zwei Identitäten, die gemeinsam die starren Barrieren des Marktes überwinden wollen, indem sie den Menschen in den Mittelpunkt des Projekts stellen: Denken, Sitzen, Ausruhen, Essen, Arbeiten, Studieren, Spielen, Schlafen, Lieben, Träumen, Sprechen. Horm und Casamania: Home & Contract.

Vol. 01
Stühle, Tische, Couch- und Beistelltische

Vol. 02
Sideboards, Wandregale und Bücherregale

Vol. 03
Kleinformel, Accessoires,
Lampen und Outdoor

Vol. 04
Betten, Bettsofas und Figi-Inseln

Vol. 05
Sofas und Sessel

Los opuestos se atraen. HORM y CASAMANIA siempre han tenido dos almas distintas, imbuidas de pura pasión por la investigación, la calidad y el diseño. Este catálogo representa el comienzo de un proyecto: un diálogo entre estos campeones del Made in Italy, partiendo de la identidad de cada uno de ellos. Horm es el estilo más riguroso, formal y elegante, caracterizado por un uso hábil de materiales puros como la madera, la piedra, el mármol y el vidrio. Casamania siempre ha jugado con la ironía, la irreverencia formal, el deseo de romper moldes en aras de la funcionalidad y la investigación. La primera ha sido siempre y lo seguirá siendo un icono de estilo y refinada elegancia en el ámbito HOME, la segunda es un referente del mercado CONTRACT. Sin embargo, los opuestos se atraen, se fusionan y se multiplican, aportando infinitas soluciones de estilo, uso y ubicación. Dos identidades que quieren romper juntas las rígidas barreras del mercado, colocando en el centro del proyecto al Ser Humano en sus múltiples actividades: pensar, sentarse, descansar, comer, trabajar, estudiar, jugar, dormir, amar, soñar, conversar. Horm y Casamania: Home & Contract.

Vol. 01
Sillas, Mesas y Mesitas

Vol. 02
Aparadores, Estanterías y Librerías

Vol. 03
Complementos de decoración,
Iluminación y Outdoor

Vol. 04
Camas, Sofás Cama e Islas Figi

Vol. 05
Sofás y Sillones

Designers



Baldanzi
& Novelli



Claudio
Bellini



Mario
Bellini



Patrizia
Bertolini



Mario
Botta



Burtcher
& Bertolini



Enrico
Cesana



Claesson
Koivisto
Rune



Carlo
Cumini



Maarten
De Ceulaer



Joe
Doucet



Dror



D'Urbino
Lomazzi



Sebastian
Errazuriz



Fabrica



GamFratesi



Daniele
Gaspardo



Jean Francois
Gornée



Grafite
Design



Harry
& Camila



Steven
Holl



Benjamin
Hubert



Giulio
Iacchetti



Salvatore
Indriolo



Toyo
Ito

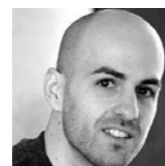

Tobias
Jurczek



LucidiPevere



Giulio
Manzoni



Ilaria
Marelli



Menguzzato
& Nascimben



Neuland,
Paster &
Geldmacher



Luca
Nichetto



Fabio
Novembre



Orlandini
Design



Josh
Owen



Palomba
Serafini
Associati



Pastorino
& Suarez



Jake
Phipps



Marcello
Pozzi



Meneghello
Paoletti
Associati



Pudelskern



Karim
Rashid



Carlo
Stefanut



Stokkeastad



Studio 63



Studio
Balutto



Studio
Habits



Marta
Szymkowiak



Marc
Thorpe



Matteo Thun
& Antonio
Rodriguez



Esa
Vesmanen



Samuel
Wilkinson



Wis
Design



Sean
Yoo



Renato
Zamberlan



StH
Orizzonti
Design
Center

114 93 — 08
 100 Alma a muro
 098, 100 Alma a terra
 056, 058 Anish Cassettiera
 054 Anish Madia
 090 Backstage
 074, 076 Blend
 030»036 Carlos
 050, 052 ComRi
 134, 136 Festival Home
 138»144 Festival Professional
 022, 024 Leon Decor
 026, 028 Leon Full Color
 012»020 Leon Wood
 044, 104»106 Network
 064 Not Riddled
 082, 084 Opus Incertum
 060, 062 Polka Dots
 128»132 QuaDror™ 04
 066, 068 Riddled Front
 092, 094 Robox
 120, 122 Sendai
 124, 126 Sendai Crystal
 096 Sinapsi
 112 Singles
 070, 072 Solaio Armadio
 116, 118 Solaio Libreria
 046, 048, 110 Spectro
 048, 108, 110 Sudoku
 038»042 Tide Buffet
 044 Tide Comò
 086, 088 Urban
 078 Valises
 102 Web Stopper
 146»150 Web System

153 Finiture e materiali
 Finishes and materials

170 Legenda dei simboli
 Key to symbols

169 Schede tecniche
 Technical sheets

Madie, comò, armadi e cassettiere
 Sideboards, dressers, wardrobes, and chests of drawers
 Buffets, comò, armoires et commodes
 Sideboards, Kleiderschränke und Schubladenschränke
 Aparadores, armarios y cajoneras



Anish Cassettiera
 056, 058



Anish Madia
 054



Blend
 074, 076



Carlos
 030, 032, 034, 036



ComRi
 050, 052



Leon Decor
 022, 024



Leon Full Color
 026, 028



Leon Wood
 012, 014, 016, 018, 020



Not Riddled
 064



Polka Dots
 060, 062



Riddled Front
 066, 068



Solaio Armadio
 070, 072



Spectro
 046, 048, 110



Tide Buffet
 038, 040, 042



Tide Comò
044



Valises
078

Librerie, scaffalature, mensole e contenitori multiuso
Bookcases, shelf units, and wall-mounted shelves
Bibliothèques, étagères et rangement murales
Bücherregale, Modulares Regale und Wandregale
Librerías, estanterías y sistemas modulares



93 – 08
114



Alma a muro
100



Sendai
120, 122



Sendai Crystal
124, 126



Sinapsi
096



Singles
112



Solaio Libreria
116, 118



Sudoku
048, 108, 110



Urban
086, 088



Web Stopper
102



Alma a terra
098, 100



Backstage
90

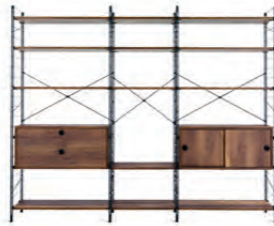

Festival Home
134, 136



Festival Professional
138, 140, 142, 144



Web System
146, 148, 150



Network
044, 104, 106

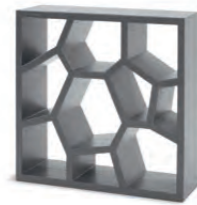

Opus Incertum
082, 084



QuaDroi™ 04
128, 130, 132



Robox
092, 094

Contenitori
Storage Units
Meubles de rangement
Sideboards
Aparadores

Leon Wood

madia / sideboard
HORM / SH, 2002
» [technical info p. 186](#)

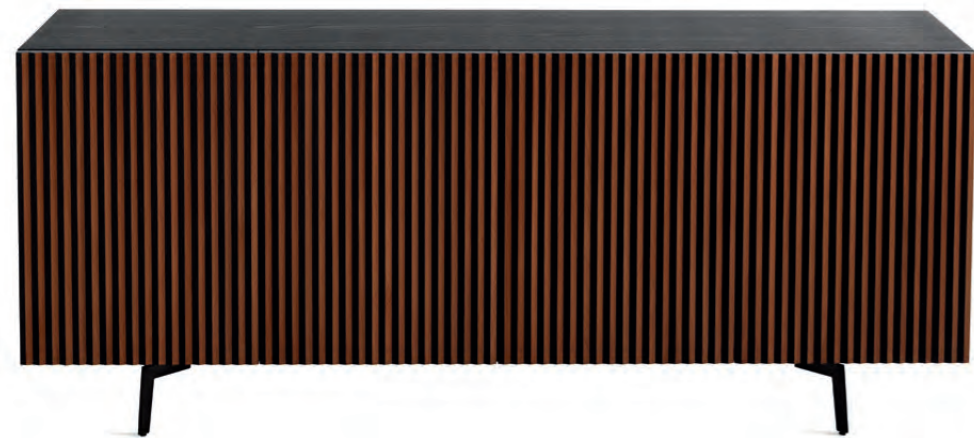

Leon Wood

madia / sideboard
HORM / SH, 2002
» [technical info p. 186](#)



Leon Wood

media / sideboard
HORM / SH, 2002
» technical info p. 186



Leon Wood

madia / sideboard
HORM / SH, 2002
» technical info p. 186



Mamanonmama
specchio / mirror
vol. 03



Leon Wood

madia / sideboard
HORM / SH, 2002
» [technical info p. 186](#)

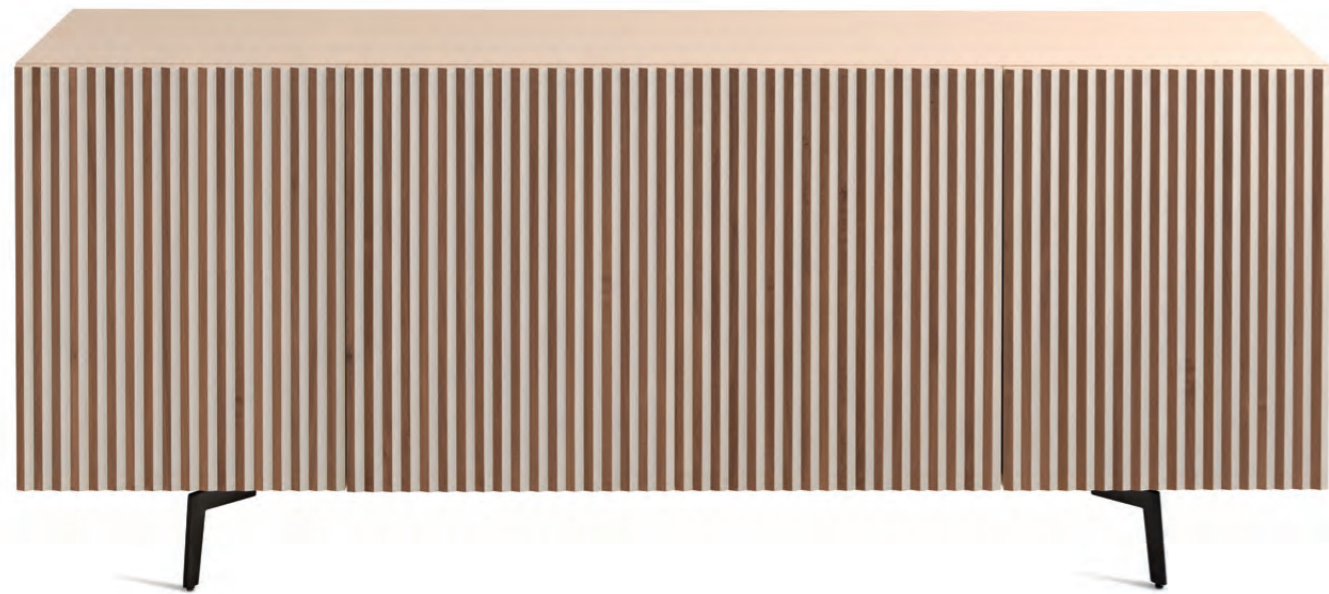

Leon Decor

madia / sideboard
HORM / SH, 2018
» technical info p. 184



Barbara
tavolo / table
vol. 01

Lepel Sedia
sedia / chair
vol. 01



Leon Decor

media / sideboard
HORM / SH, 2018
» technical info p. 184



026

Leon Full Color

madia / sideboard
HORM / SH, 2018
» [technical info p. 185](#)

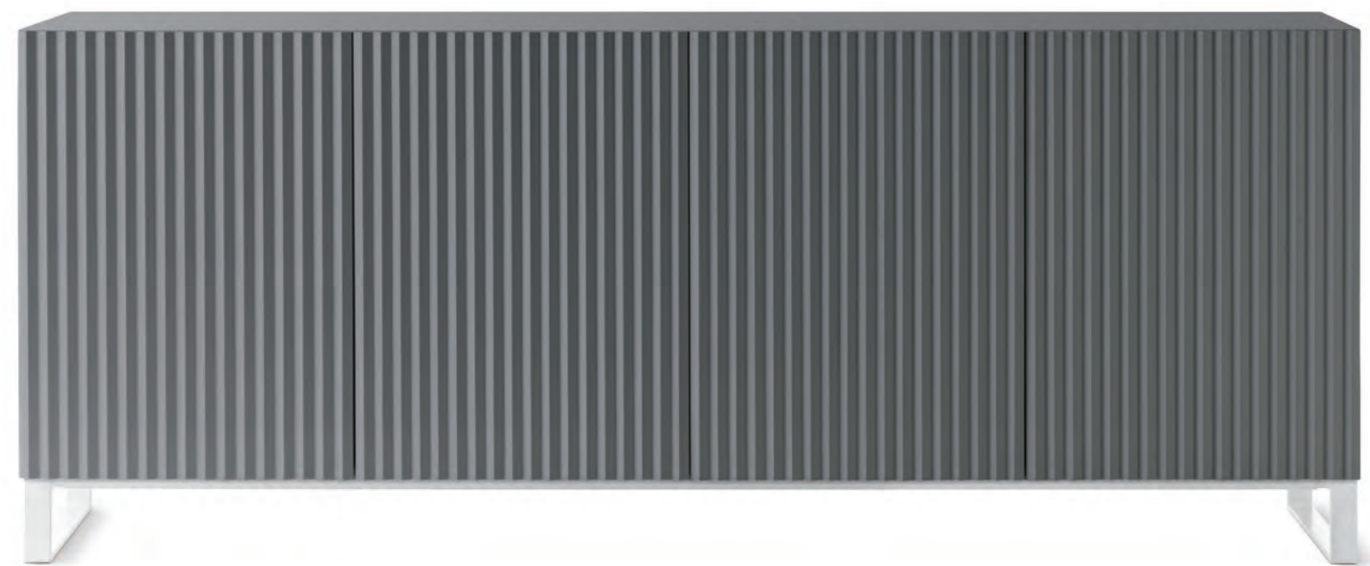

027



H

Leon Full Color

madia / sideboard
HORM / SH, 2018
» [technical info p. 185](#)

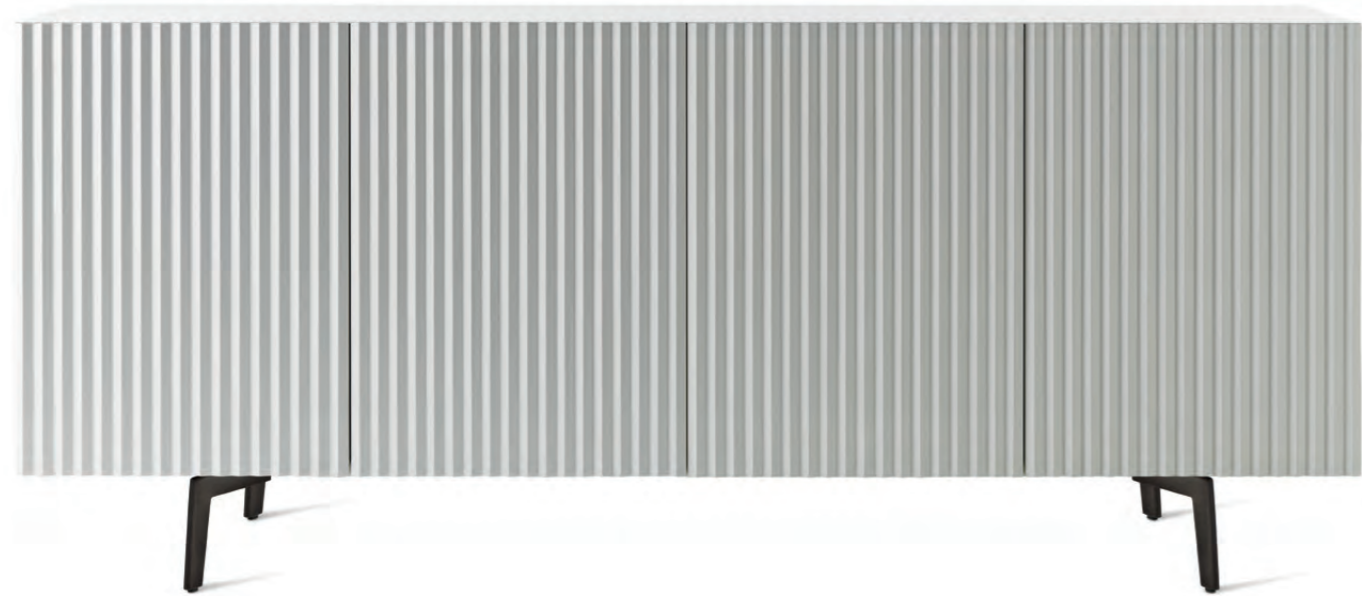

Carlos

madia / sideboard
HORM / Renato Zamberlan, 2014
» [technical info p. 178](#)



Carlos

madia / sideboard
HORM / Renato Zamberlan, 2014
» [technical info p. 178](#)



Carlos

madia / sideboard
HORM / Renato Zamberlan, 2014
» [technical info p. 178](#)



Ray Poltroncina
sedia con braccioli / chair with armrests
vol. 01

Autoreggente Tavolo
tavolo / table
vol. 01

036

Carlos

media / sideboard
HORM / Renato Zamberlan, 2014
» [technical info p. 178](#)

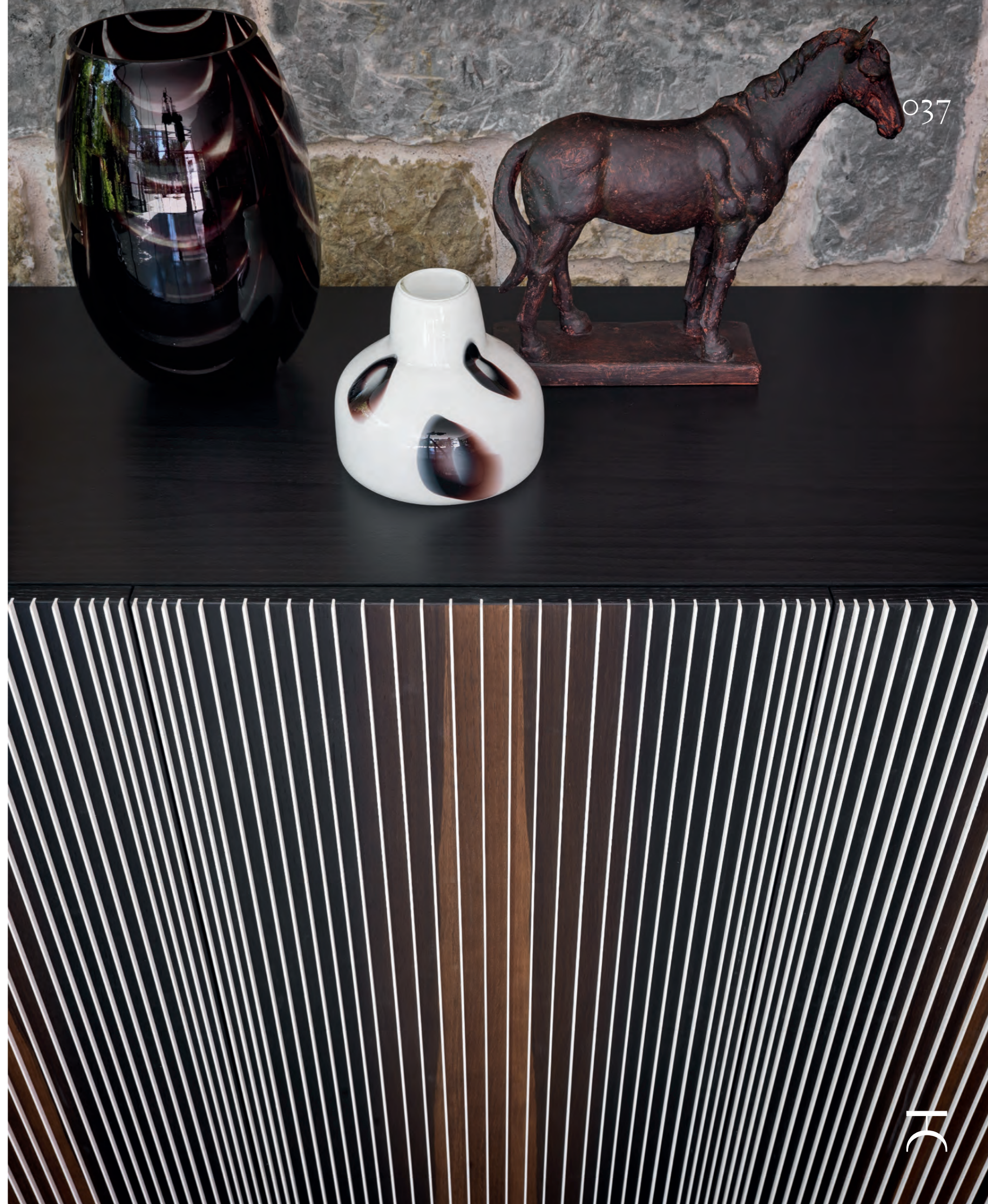

Tide Buffet

media / sideboard
 HORM / Karim Rashid, 2006
 » [technical info p. 202](#)



Albino Family
 tavolino / coffee and side table
 vol. 01

Tide Buffet

media / sideboard
HORM / Karim Rashid, 2006
» [technical info p. 202](#)



Tide Buffet

media / sideboard
HORM / Karim Rashid, 2006
» [technical info p. 202](#)



Tide Comò

comò / chest of drawers
 HORM / Karim Rashid, 2006
 » [technical info p. 203](#)



Network

libreria / bookcase
 CASAMANIA / Neuland, Paster & Geldmacher, 2014
 » [technical info p. 187](#)



Spectro

madia / sideboard
CASAMANIA / Claesson Koivisto Rune, 2018
» technical info p. 200



Cherish
sedia / chair
vol. 01

Bolero
tavolo / table
vol. 01

Spectro

madia / sideboard
CASAMANIA / Claesson Koivisto Rune, 2018
» [technical info p. 200](#)

Sudoku

libreria / bookcase
HORM / Mario Bellini, 2007
» [technical info p. 201](#)



ComRi

media / sideboard
HORM / SHH - homage to Toyo Ito, 2010
» [technical info p. 179](#)



ComRi

madia / sideboard

HORM / SHH - homage to Toyo Ito, 2010

» [technical info p. 179](#)



Anish Madia

madia / sideboard
HORM / Indriolo & Gaspardo, 2011
» [technical info p. 175](#)



Anish Cassettiera

cassettiera / chest of drawers
HORM / Indriolo & Gaspardo, 2011
» [technical info p. 174](#)



058

Anish Cassettiera

cassettiera / chest of drawers
HORM / Indriolo & Gaspardo, 2011
» [technical info p. 174](#)

059

Nest
letto / bed
vol. 04

HC

Polka Dots

madia / sideboard
HORM / Toyo Ito, 2003
» technical info p. 190



Ginevra
sedia con braccioli / chair with armrests
vol. 01

Polka Dots

media / sideboard
HORM / Toyo Ito, 2003
» technical info p. 190



Woodclock
orologio da parete / wall-mounted clock
vol. 03

Not Riddled

madia / sideboard
HORM / Steven Holl, 2007
» [technical info p. 188](#)



Riddled Front

media / sideboard
HORM / Steven Holl, 2007
» [technical info p. 192](#)



Riddled Front

media / sideboard
HORM / Steven Holl, 2007
» technical info p. 192

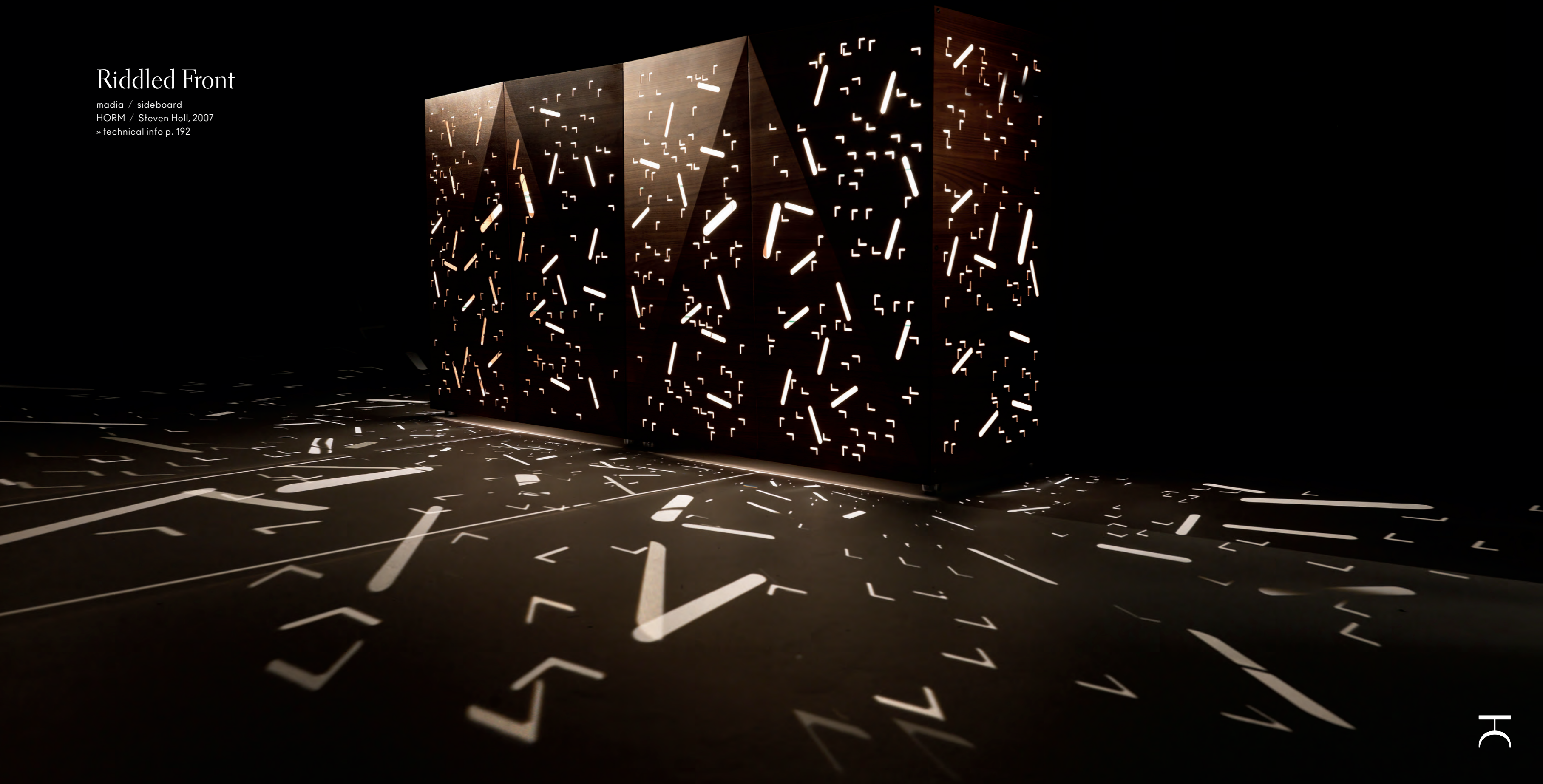

Solaio Armadio

armadio / wardrobe
 HORM / Carlo Cumini, 1997
 » [technical info p. 198](#)



Solaio Armadio

armadio / wardrobe
HORM / Carlo Cumini, 1997
» [technical info p. 198](#)



Blend

armadio / wardrobe
HORM / Karim Rashid, 2006
» [technical info p. 177](#)



Blend

armadio / wardrobe
HORM / Karim Rashid, 2006
» [technical info p. 177](#)



Valises

armadio / wardrobe
CASAMANIA / Maarten De Ceulaer, 2008
» [technical info p. 204](#)



Mensole e Librerie
Shelving Solutions
Etagères et Bibliothèques
Wandregale und Bücherregale
Estanterías y Librerías

Opus Incertum

contenitore multiuso / multiuse shelf organizer

CASAMANIA / Sean Yoo, 2005

» technical info p. 189



Velasca
sedia con braccioli / chair with armrests
vol. 01

Opus Incertum

contenitore multiuso / multiuse shelf organizer
CASAMANIA / Sean Yoo, 2005
» [technical info p. 189](#)



Morfino & Morfino Pouf
bean bag e pouf / bean bag and ottoman
vol. 03

Urban

contenitore multiuso / multiuse shelf organizer

CASAMANIA / Claudio Bellini, 2009

» [technical info p. 204](#)



Urban

libreria / bookcase
CASAMANIA / Claudio Bellini, 2009
» technical info p. 204



Raphia Rattan
sedia con braccioli / chair with armrests
vol. 01



Backstage

contenitore multiuso / multiuse storage organizer
HORM / Salvatore Indriolo, 2010
» [technical info p. 176](#)



Robox

libreria / bookcase
CASAMANIA / Fabio Novembre, 2011
» [technical info p. 193](#)



Robox

libreria / bookcase
CASAMANIA / Fabio Novembre, 2011
» technical info p. 193



Sinapsi

mensola a parete / wall shelf
HORM / Sebastian Errazuriz, 2010
» [technical info p. 196](#)



Alma a terra

contenitore multiuso / multiuse storage organizer
CASAMANIA / Studio 63, 2011 – 2012
» [technical info p. 173](#)

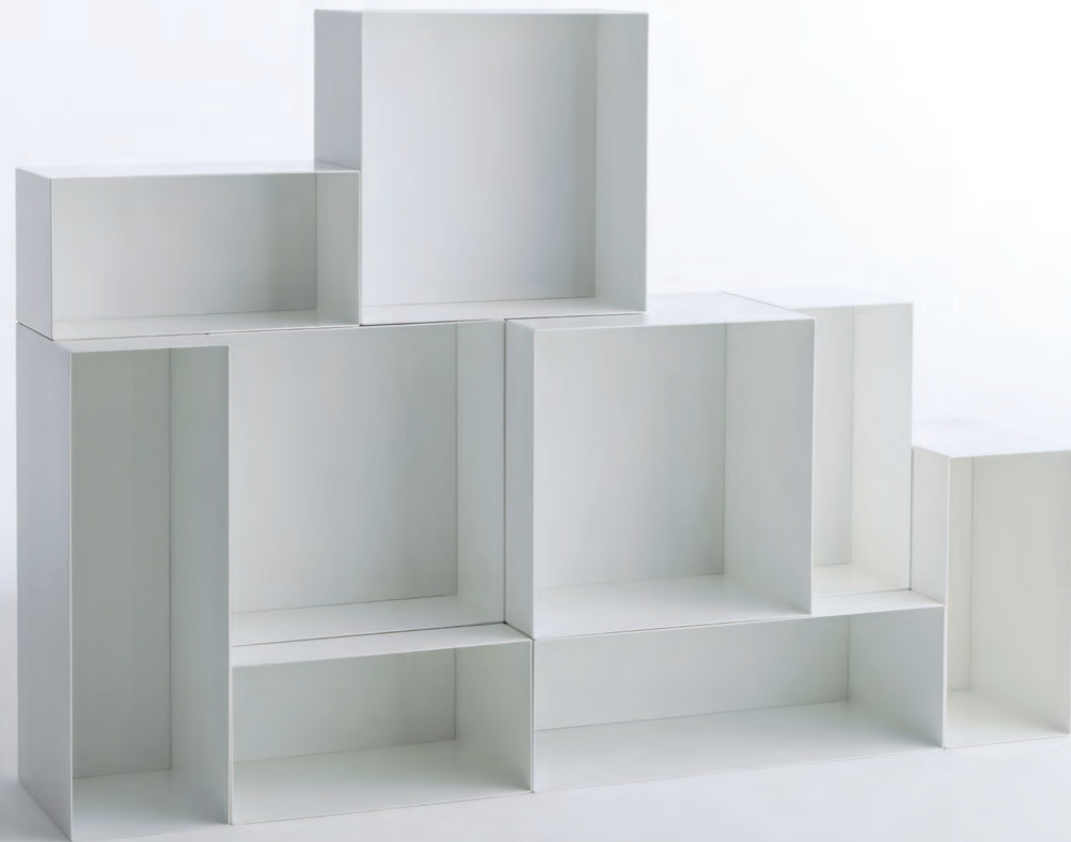

Alma a muro

contenitore multiuso / multiuse wall mounted shelf organizer
CASAMANIA / Studio 63, 2011 – 2012
» [technical info p. 173](#)



Alma a terra

contenitore multiuso / multiuse storage organizer
CASAMANIA / Studio 63, 2011 – 2012
» [technical info p. 173](#)



Web Stopper

mensola a parete / wall shelf
CASAMANIA / Menguzzato & Nascimben, 2006
» [technical info p. 205](#)



Network

libreria / bookcase

CASAMANIA / Neuland, Pasteur & Geldmacher, 2014

» [technical info p. 187](#)



Network

libreria / bookcase

CASAMANIA / Neuland, Pasteur & Geldmacher, 2014

» [technical info p. 187](#)



Giro Pouf
pouf / ottoman
vol. 01



Singles

libreria / bookcase
HORM / Carlo Cumini, 2004
» technical info p. 197



Ki
sedia / chair
vol. 01

93 - 08

libreria / bookcase
HORM / Carlo Cumini, 2008
» technical info p. 172



Solaio Libreria

libreria / bookcase
 HORM / Carlo Cumini, 1993 – 2018
 » technical info p. 199



Samoa Large
 divano letto / sofa bed
 vol. 04

Giro Tavolino
 tavolino / coffee table
 vol. 01

Giro Pouf
 pouf / ottoman
 vol. 01

Solaio Libreria

libreria / bookcase
HORM / Carlo Cumini, 1993 – 2018
» [technical info p. 199](#)

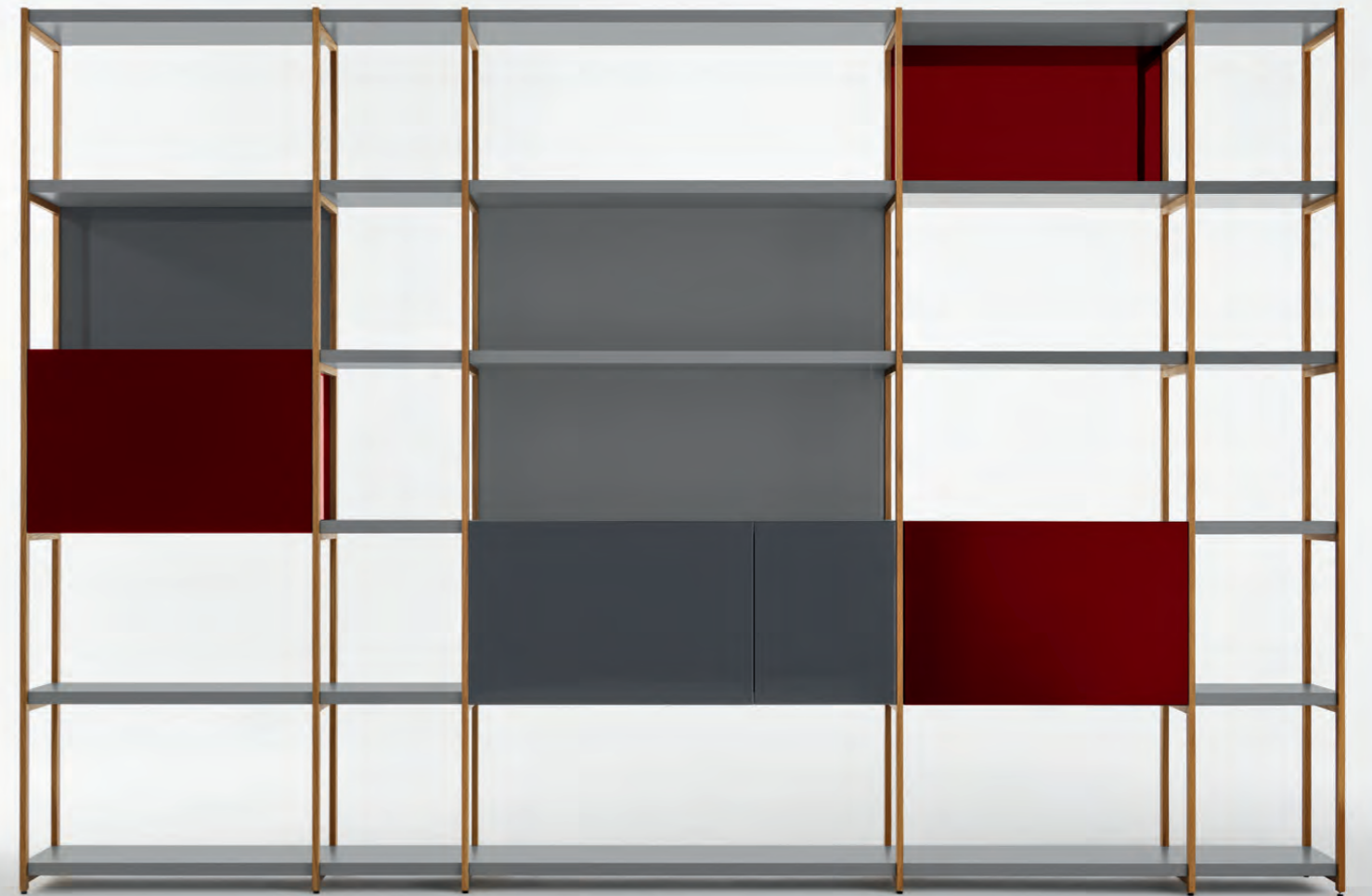

Sendai

libreria / bookcase
HORM / Toyo Ito, 2004
» [technical info p. 194](#)

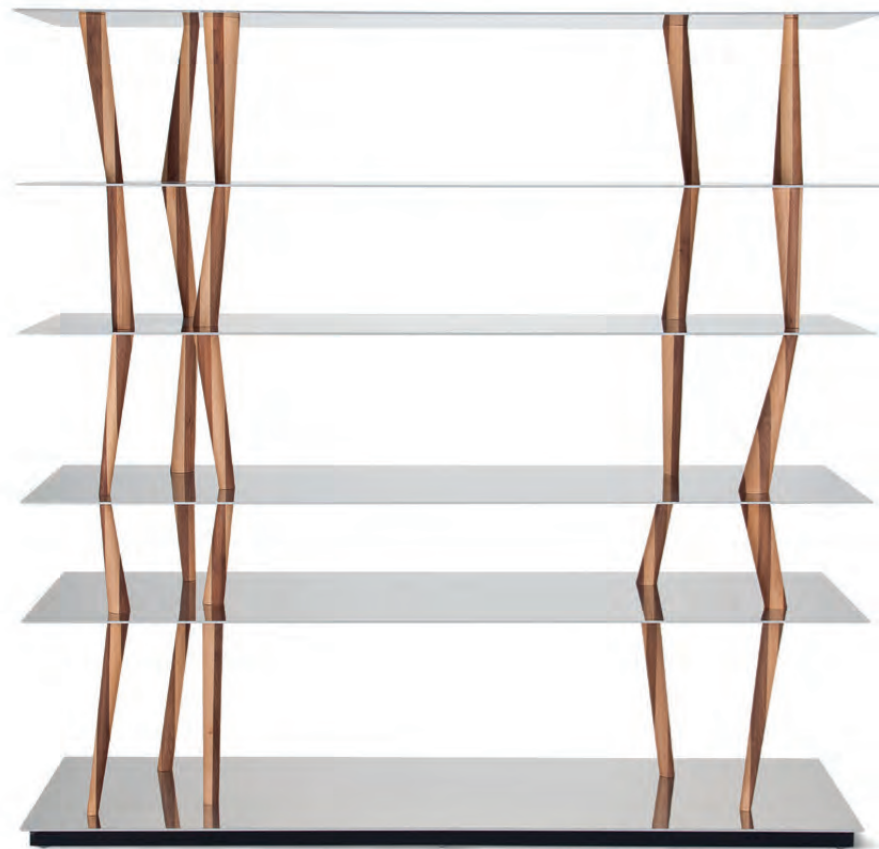

Sendai

libreria / bookcase
HORM / Toyo Ito, 2004
» [technical info p. 194](#)



Ripples
panca / bench
vol. 01

Hexagon
tavolino / side table
vol. 01

Mamanonmama
specchio / mirror
vol. 03

Sendai Crystal

libreria / bookcase
HORM / Toyo Ito, 2013
» technical info p. 195

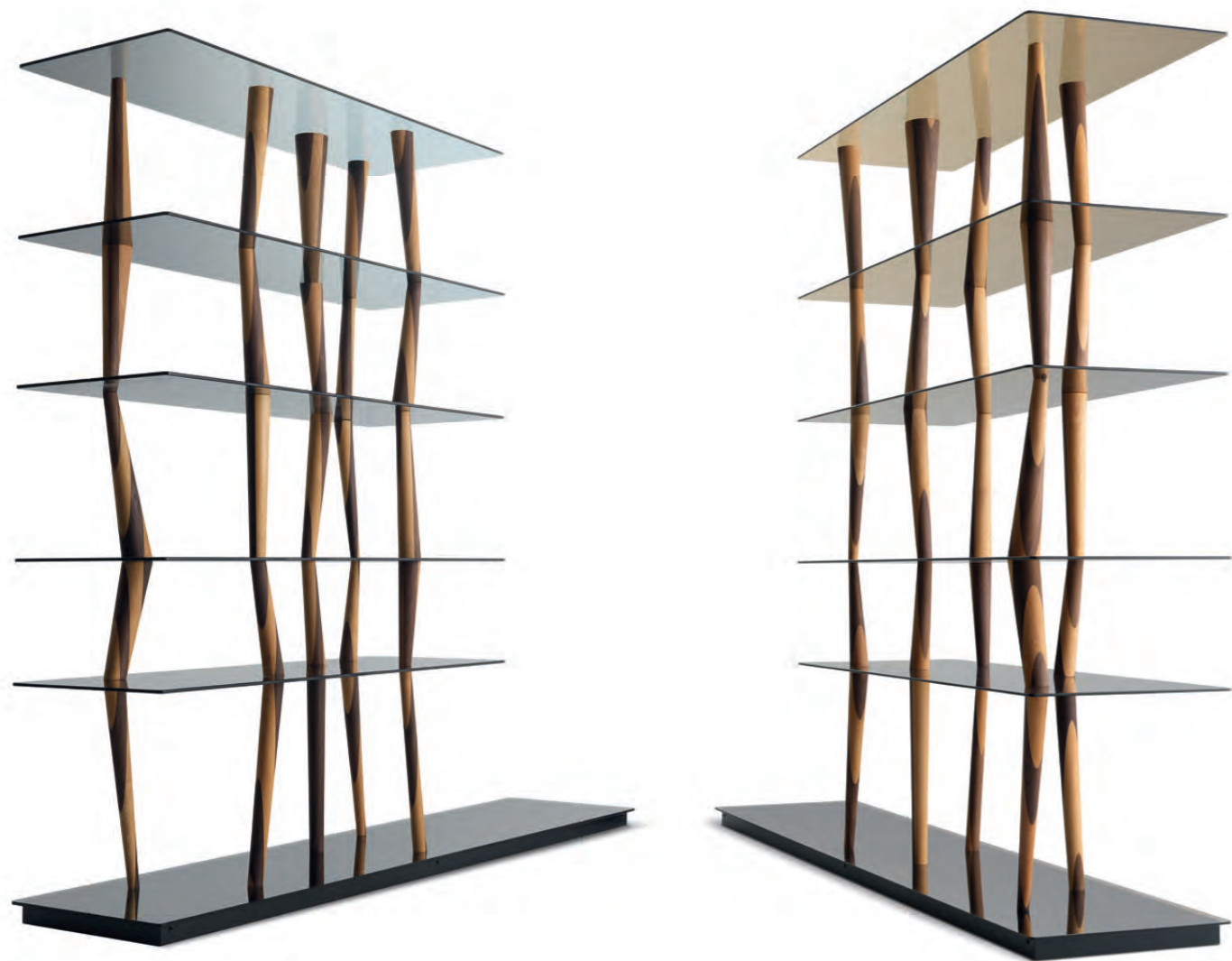

Sendai Crystal

libreria / bookcase
HORM / Toyo Ito, 2013
» technical info p. 195

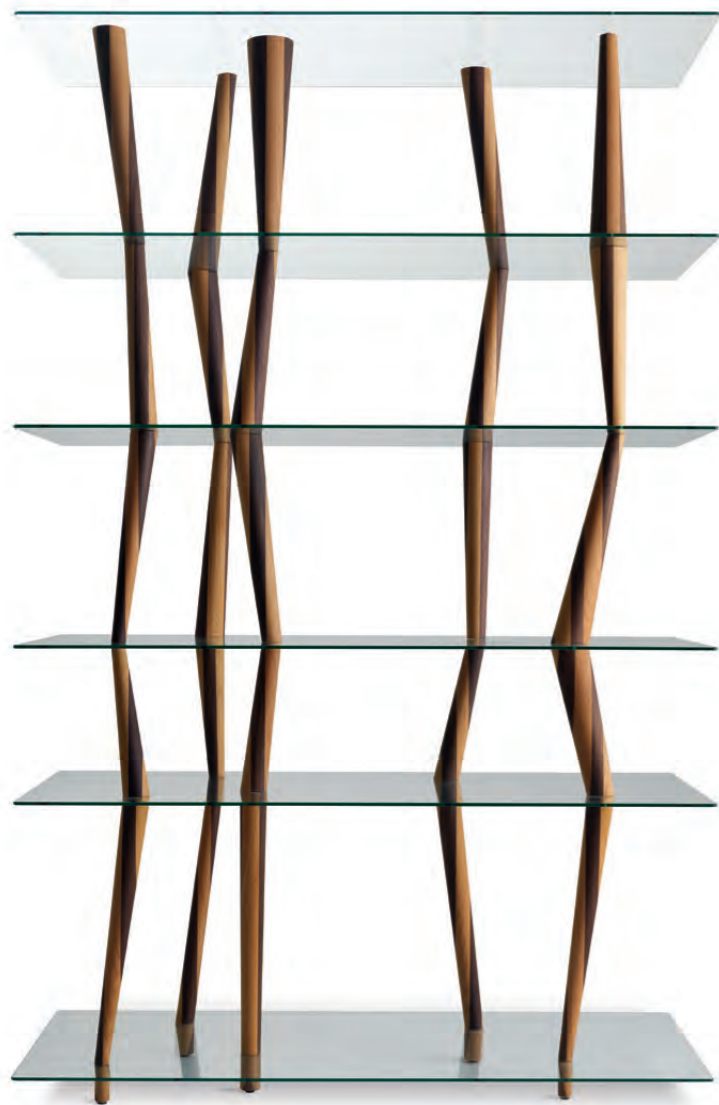

QuaDror™ 04

libreria / bookcase
HORM / Dror, 2015
» technical info p. 191



QuaDror™ 04

libreria / bookcase
HORM / Dror, 2015
» [technical info p. 191](#)



Ray Poltroncina
sedia con braccioli / chair with armrests
vol. 01

QuaDror™ 02
tavolo / table
vol. 01

QuaDror™ 04

libreria / bookcase
HORM / Dror, 2015
» technical info p. 191

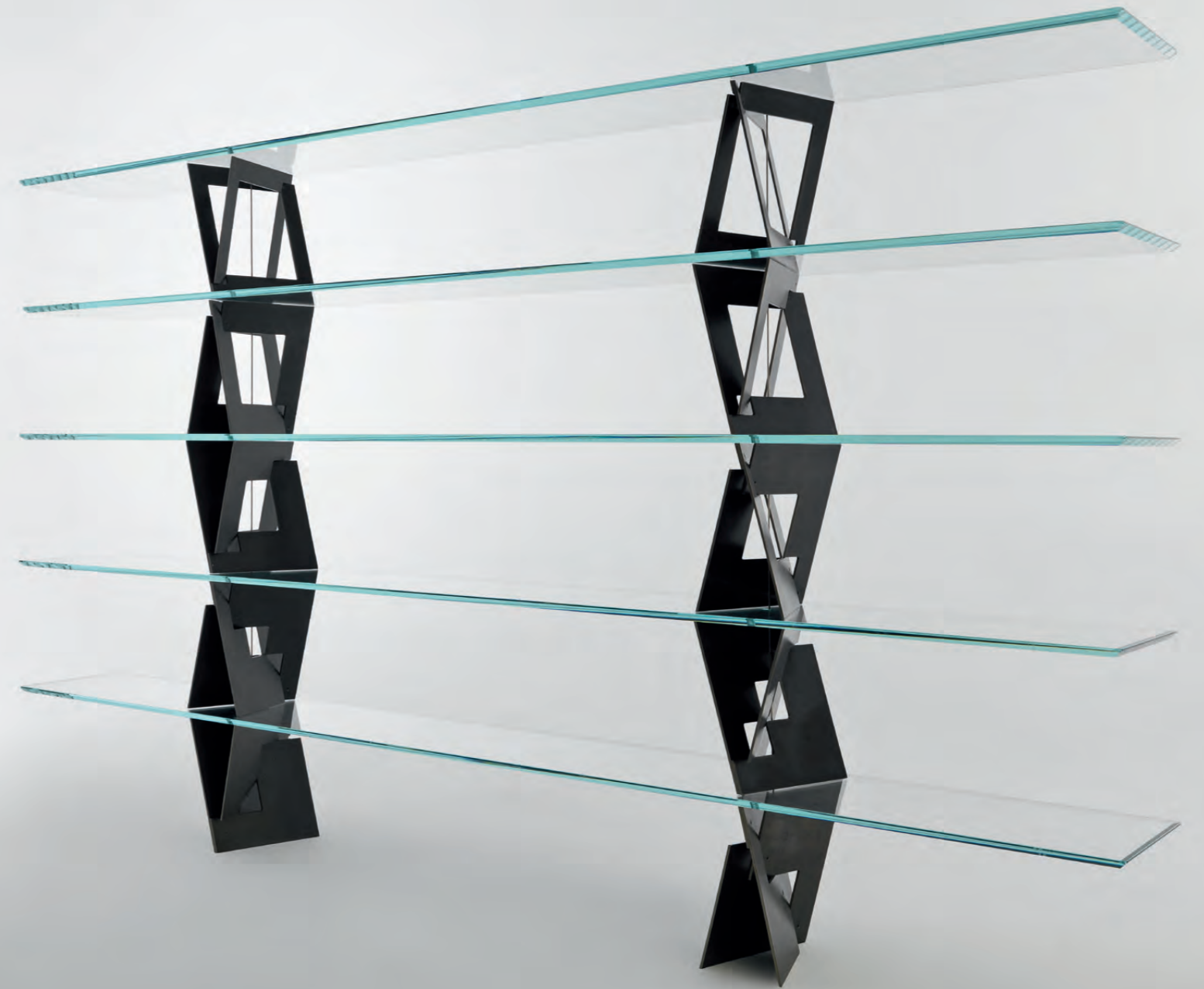

Festival Home

scaffalatura / shelving system
 CASAMANIA / Baldanzi & Novelli, 1987
 » [technical info p. 180](#)



Festival Home

scaffalatura / shelving system
CASAMANIA / Baldanzi & Novelli, 1987
» [technical info p. 180](#)



Festival Professional

scaffalatura / shelving system
CASAMANIA / Baldanzi & Novelli, 1987
» technical info p. 182



Festival Professional

scaffalatura / shelving system
CASAMANIA / Baldanzi & Novelli, 1987
» technical info p. 182



Morfino Pouf
pouf / ottoman
vol. 01



Maria
oggetto decorativo / decorative object
vol. 03

Korzina
gettacarte / wastepaper basket
vol. 03

Festival Professional

scaffalatura / shelving system
 CASAMANIA / Baldanzi & Novelli, 1987
 » [technical info p. 182](#)



Festival Professional

scaffalatura / shelving system
CASAMANIA / Baldanzi & Novelli, 1987
» technical info p. 182

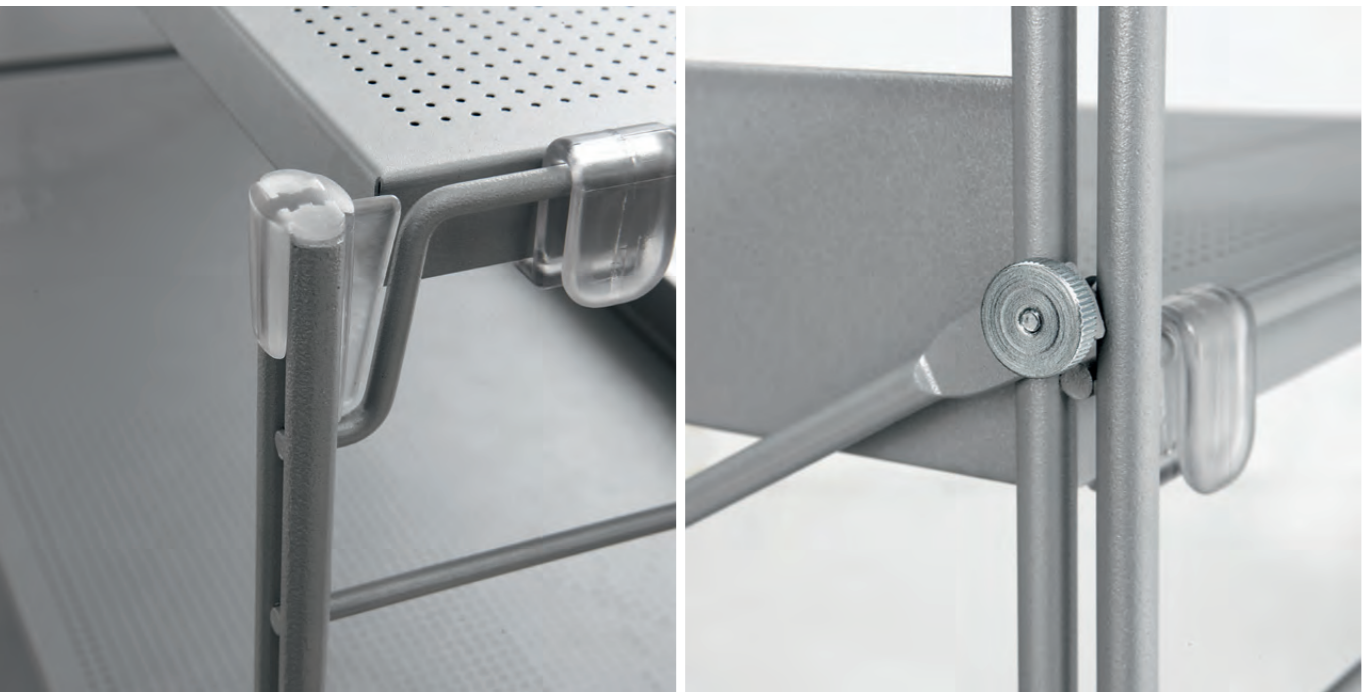

Web System

scaffalatura / shelving system

CASAMANIA / Menguzzato & Nascimben, 2001

» technical info p. 206



Web System

scaffalatura / shelving system
CASAMANIA / Menguzzato & Nascimben, 2001
» [technical info p. 206](#)



Web System

scaffalatura / shelving system
CASAMANIA / Menguzzato & Nascimben, 2001
» [technical info p. 206](#)



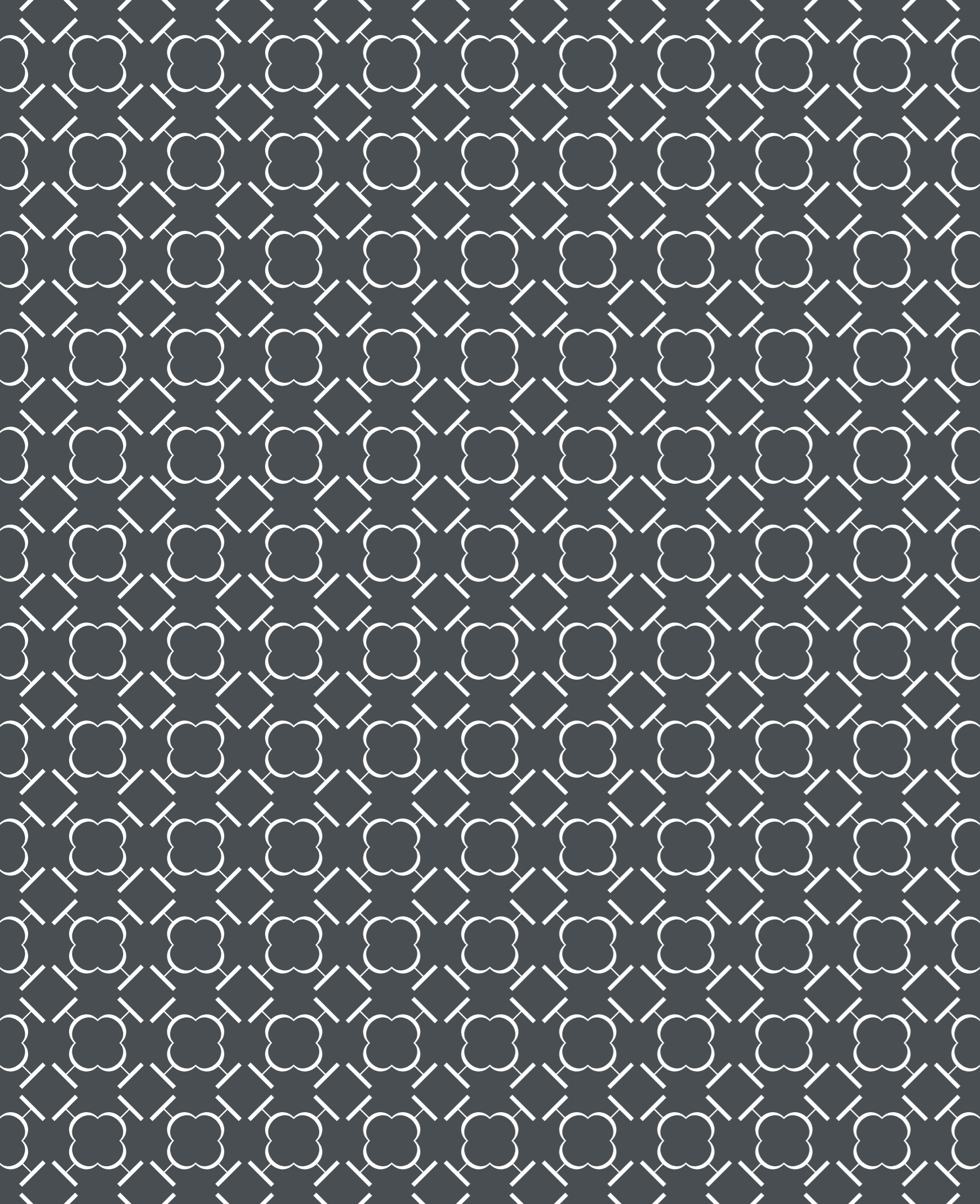

Finiture e materiali
Finishes and materials
Finitions et matériaux
Ausführungen und Materialien
Acabados y materiales

faggio imbiancato
whitened beech
hêtre blanchi
Buche geweißt
haya blanqueada



Cherish / Hcb /
Leon Wood / Ray Sedia /
Spectro / Twist

faggio naturale
natural beech
hêtre naturel
Buche Natur
haya natural

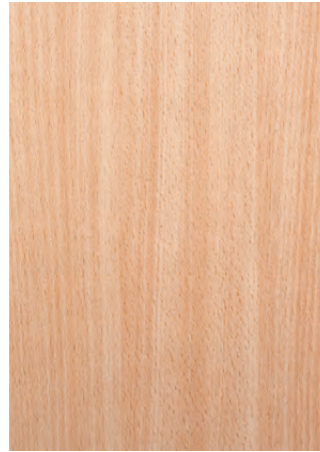

Cherish / Twist

faggio bois blond
bois blond beech
hêtre bois blond
Buche Bois Blond
haya bois blond



Hcb / Leon Wood /
Spectro / Twist

faggio mocha
mocha beech
hêtre moka
Buche Mokka
haya mocha

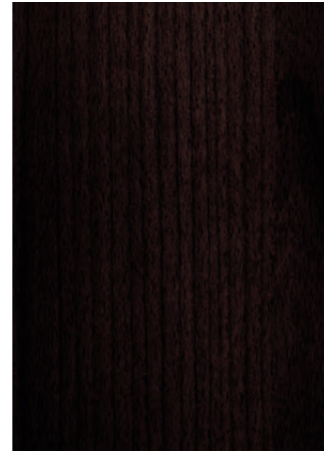

Anish / Carlos / Cherish /
Hcb / Leon Wood / Pressious /
Ray Sedia / Spectro / Twist

frassino bianco
white ash
frêne blanc
Esche Weiß
fresno blanco



Ki

frassino tinto rovere
oak-stained ash
frêne teinté chêne
eichefarbig gebeizt Esche
fresno teñido roble



La Dina / Milady /
Velasca

frassino beige
beige grey ash
frêne gris beige
Esche Beigegrau
fresno gris beige



Carnaby / La Dina /
Milady / Velasca

frassino mocha
mocha ash
frêne moka
Esche Mokka
fresno mocha



La Dina / Ma.Re /
QuaDror 01 / QuaDror 03 /
QuaDror 04

frassino nero
black ash
frêne noir
Esche Schwarz
fresno negro



Carnaby / Ki / Milady /
Pablita / Sienna / Soho /
Velasca

rovere bianco
white oak
chêne blanc
Eiche Weiß
roble blanco



Andaman / Chariot /
Meduse Tavolo / Moheli / Xx

rovere naturale
natural oak
chêne naturel
Eiche Natur
roble natural



Alberto Appendiabiti / Albino Family / Autoreggente Tavolo /
Bolero / Capriata / Chariot / Cobra / Giro Tavolino /
J – Table / Leon Decor / Lily / Maritime / Meduse Tavolo /
Ray Poltroncina & Sedia / Solaio Armadio & Libreria / Sottiletto /
Stereo Wood / Tango / Twine / Twine Tavolino / Vad Wood /
Woodclock / Wow! Plus / Xx

rovere beige
beige grey oak
chêne gris beige
Eiche Beigegrau
roble gris beige



Maritime

rovere mocha
mocha oak
chêne moka
Eiche Mokka
roble mocha



Andaman / Barbara /
Capriata / Chariot / Cobra /
Maritime / Meduse Tavolo /
Moheli / Solaio Armadio &
Libreria / Sottiletto /
Twine Tavolino / Xx

noce canaletto
walnut
noyer
Nussbaum
nogal

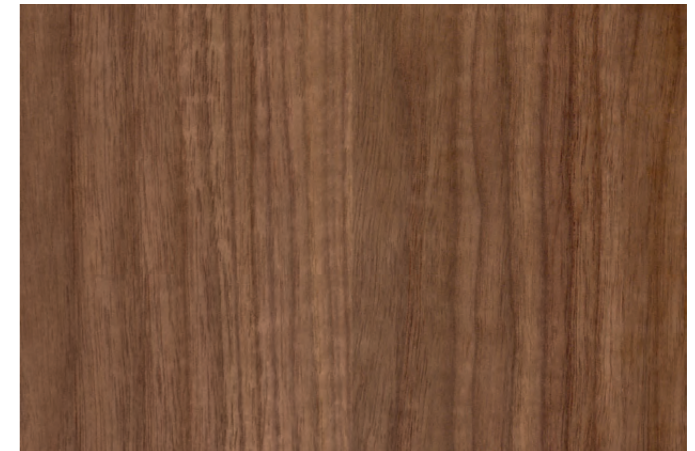

93 – 08 / Albino Family / Albino Torcia / Anish /
Autoreggente / Barbara / Bifronte / Bolero / Bureau / Cobra /
Flower / Ginevra / Io e Te / J – Table / Ki / Leon Decor /
Lily / Meduse Tavolo / Numero 3 / Ray Poltroncina & Sedia /
Singles / Sottiletto / Stereo Wood / Tango / Tribeca / Tutù /
Twine / Twine Tavolino / Vad Wood / Wow! Plus / Woodclock

okumé
okoume
okumé
Okume
ocume



Hexagon / Ripples Outdoor

ontano + noce canaletto
alder + walnut
aulne + noyer
Erle + Nussbaum
aliso + nogal



Sendai / Sendai Crystal

nero-bianco
black-white
noir-blanc
Schwarz-Weiß
negro-blanco

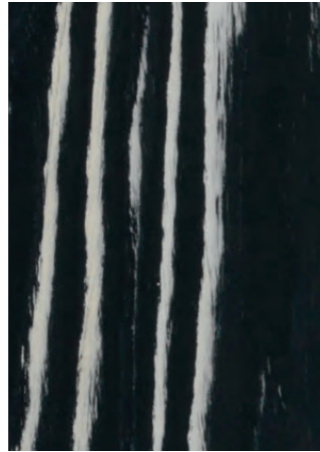

Sudoku

salice nero
black willow
saule noir
Weide Schwarz
sauce negro



Mamanonmama

legno origami in noce canaletto — brevetto HORM
origami wood in walnut — HORM patent
bois origami en noyer — brevet HORM
Origami-Nussbaum — HORM-Patent
madera origami de nogal — patente HORM



Not Riddled / Plywood Chandelier / Riddled Front / Riddled Table / Riddled Totem

legno origami in ebano — brevetto HORM
origami wood in ebony — HORM patent
bois origami en ébène — brevet HORM
Origami-Ebenholz — HORM-Patent
madera origami de ébano — patente HORM

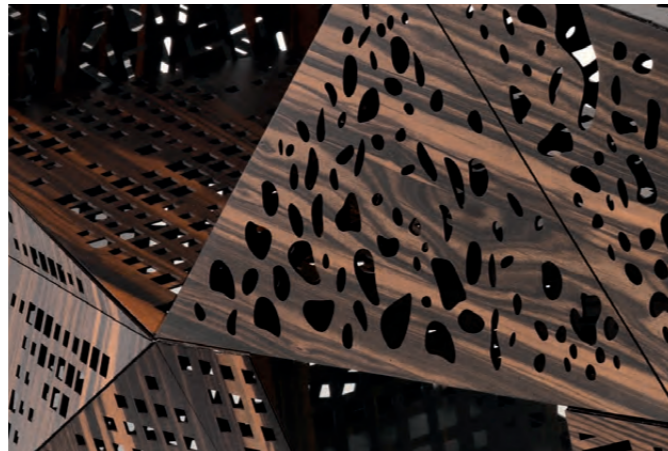

Riddled Buffet

rovere termotrattato + HPL bianco
thermo-treated oak + white HPL
chêne thermotraité + HPL blanc
wärmebehandelte Eiche + HPL Weiß
roble termotrattado + HPL blanco

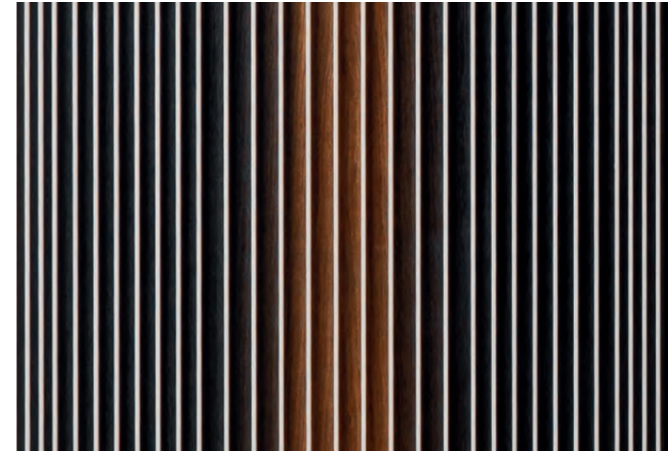

Carlos

noce canaletto / mogano / ciliegio / rovere / frassino
walnut / mahogany / cherry / oak / ash
noyer / acajou / cerisier / chêne / frêne
Nussbaum / Mahagoni / Kirsche / Eiche / Esche
nogal / caoba / cerezo / roble / fresno



Bifronte / ComRi / Ripples / Ripples — Like a River / Ripples Sgabello / Ripples Tavolo

faggio imbiancato / faggio moca / faggio naturale
whitened beech / mocha beech / natural beech
hêtre blanchi / hêtre moka / hêtre naturel
Buche geweißt / Buche Mokka / Buche Natur
haya blanqueada / haya moca / haya natural



Twist Tricolor

faggio imbiancato / faggio bois blond / arancio / giallo
whitened beech / bois blond beech / orange / yellow
hêtre blanchi / hêtre bois blond / orange / jaune
Buche geweißt / Buche Bois Blond / Orange / Gelb
haya blanqueada / haya bois blond / naranja / amarillo





Twist Multicolor

nero black noir Schwarz negro	bianco white blanc Weiß blanco	polvere dusty grey gris poussière Staubgrau gris polvo	beige beige grey gris beige Beigegrau gris beige
			
Vedi schede tecniche See technical sheets Voir les fiches techniques Siehe technische Datenblätter Ver fichas técnicas	Vedi schede tecniche See technical sheets Voir les fiches techniques Siehe technische Datenblätter Ver fichas técnicas	Vedi schede tecniche See technical sheets Voir les fiches techniques Siehe technische Datenblätter Ver fichas técnicas	Vedi schede tecniche See technical sheets Voir les fiches techniques Siehe technische Datenblätter Ver fichas técnicas

rosso vino wine red rouge vin Weinrot rojo vino	bruno brown grey gris brun Braungrau gris parduzco	grafite graphite graphite Graphit grafito	rosso chiaro brillante luminous bright red rouge clair brillant Leuchthellrot rojo claro brillante
			
Vedi schede tecniche See technical sheets Voir les fiches techniques Siehe technische Datenblätter Ver fichas técnicas	Vedi schede tecniche See technical sheets Voir les fiches techniques Siehe technische Datenblätter Ver fichas técnicas	Vedi schede tecniche See technical sheets Voir les fiches techniques Siehe technische Datenblätter Ver fichas técnicas	Chariot

(*)

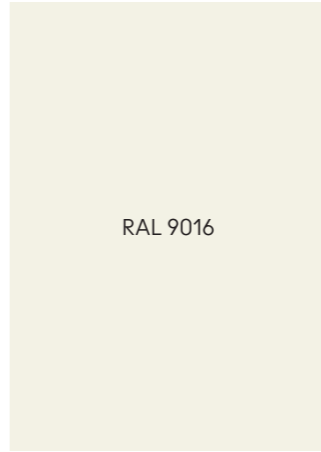
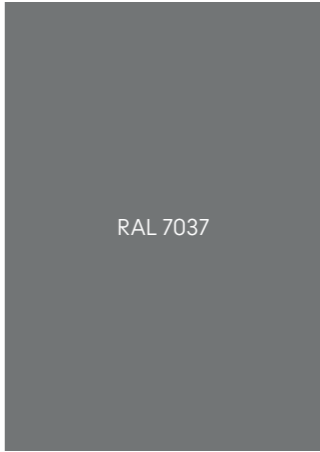
Polypropylene / Polyethylene / Polyamide

nero black noir Schwarz negro	bianco white blanc Weiß blanco	polvere dusty grey gris poussière Staubgrau gris polvo	beige beige grey gris beige Beigegrau gris beige
			
Vedi schede tecniche See technical sheets Voir les fiches techniques Siehe technische Datenblätter Ver fichas técnicas	Vedi schede tecniche See technical sheets Voir les fiches techniques Siehe technische Datenblätter Ver fichas técnicas	Vedi schede tecniche See technical sheets Voir les fiches techniques Siehe technische Datenblätter Ver fichas técnicas	Vedi schede tecniche See technical sheets Voir les fiches techniques Siehe technische Datenblätter Ver fichas técnicas

rosso vino wine red rouge vin Weinrot rojo vino	bruno brown grey gris brun Braungrau gris parduzco	grafite graphite graphite Graphit grafito	
			
Vedi schede tecniche See technical sheets Voir les fiches techniques Siehe technische Datenblätter Ver fichas técnicas	Vedi schede tecniche See technical sheets Voir les fiches techniques Siehe technische Datenblätter Ver fichas técnicas	Vedi schede tecniche See technical sheets Voir les fiches techniques Siehe technische Datenblätter Ver fichas técnicas	

brunito
burnished
bruni
Brüniert
bruñido



Basamento Mid-Century
Modern

crudo
crude
cru
Roh
crudo

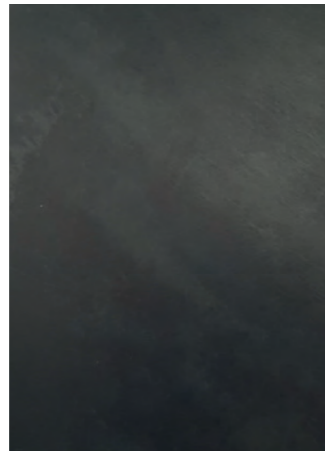

QuaDror 01 / QuaDror 02 /
Torii

verniciato bronzo antico
antique bronze painted
verni bronze antique
Vintage Bronze beschichtet
pintado de bronce antiguo



Meduse Tavolo / Network

verniciato oro
gold painted
verni or
Gold beschichtet
pintado de oro



Chariot

cromato
chromed
chromé
Chrom
cromado



Bar / Sin / Stereo Impilabile /
T2 / Vad Girevole /
Vad Impilabile

cromo nero
black chrome
chrome noir
Schwarz Chrom
cromo negro



Albino Family

marmo Carrara
Carrara marble
marbre Carrara
Carrara Marmor
mármol Carrara

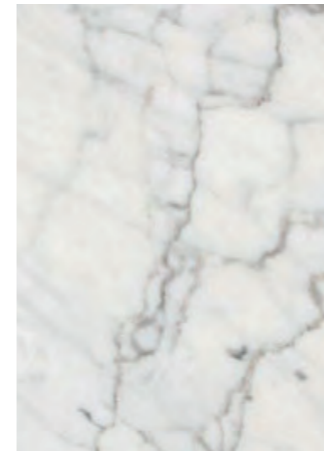

Albino Family / Flower /
Lily / Meduse Tavolo

marmo Emperador
Emperador marble
marbre Emperador
Emperador Marmor
mármol Emperador

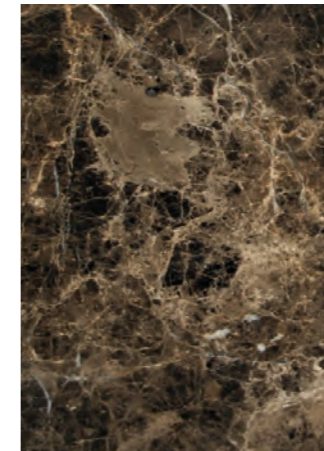

Albino Family / Barbara /
Lily / Meduse Tavolo /
Tout le Jour Tavolino

marmo Marquina
Marquina marble
marbre Marquina
Marquina Marmor
mármol Marquina

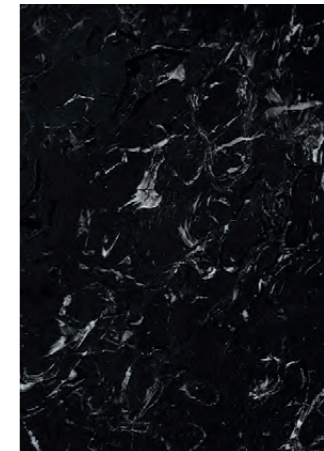

Albino Family / Barbara /
Flower / Lily / Meduse
Tavolo / Tout le Jour Tavolino

pietra leccese
Lecce limestone
pierre de Lecce
Lecce-Stein
piedra de Lecce



Hexagon

ceramica grigia
grey ceramic
céramique gris
graue Keramik
cerámica gris



Ma.Re / Torii

cemento
concrete
béton
Beton
hormigón



Barbara

bianco
white
blanc
Weiß
blanco



Maria

bordeaux
bordeaux
bordeaux
bordeaux

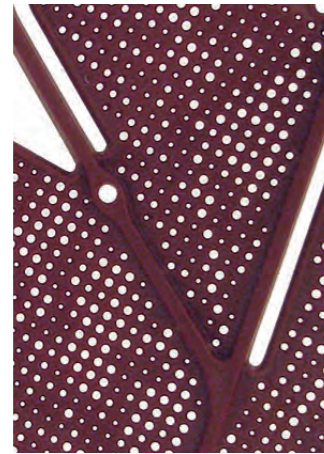

Maria

verde scuro
dark green
vert foncé
Dunkelgrün
verde oscuro

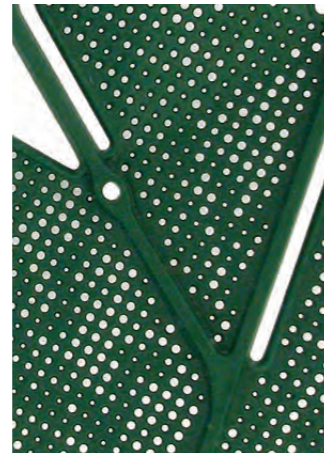

Maria

verde chiaro
light green
vert clair
Lichtgrün
verde claro



Maria

p. espanso nero
expanded p. black
p. expansé noir
expandiertes P. Schwarz
p. expandido negro

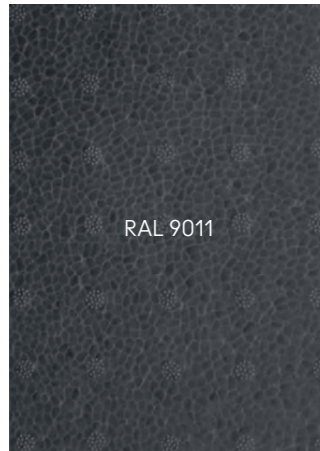

Opus Incertum

p. espanso bianco
expanded p. white
p. expansé blanc
expandiertes P. Weiß
p. expandido blanco



Opus Incertum

p. espanso polvere
expanded p. dusty grey
p. expansé gris poussière
expandiertes P. Staubgrau
p. expandido gris polvo



Opus Incertum

p. espanso beige
expanded p. beige grey
p. expansé gris beige
expandiertes P. Beigegrau
p. expandido gris beige



Opus Incertum

nero
black
noir
Schwarz
negro

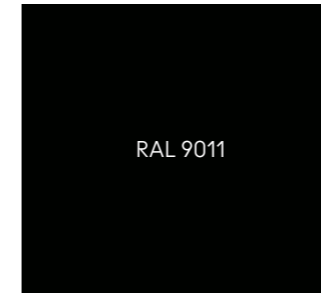
Him & Her Lucida /
Korzina / Zontik

bianco
white
blanc
Weiß
blanco

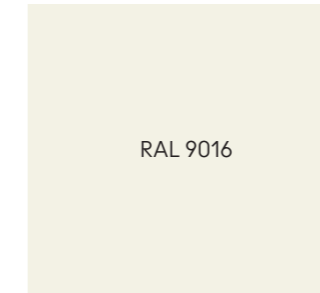

Him & Her Lucida

polvere
dusty grey
gris poussière
Staubgrau
gris polvo

Him & Her Lucida /
Korzina / Zontik

beige
beige grey
gris beige
Beigegrau
gris beige

Him & Her Lucida /
Korzina / Zontik

rosso vino
wine red
rouge vin
Weinrot
rojo vino

Him & Her Lucida /
Korzina / Zontik

grafite
graphite
graphite
Graphit
grafito

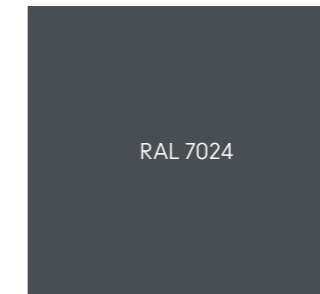

Him & Her Lucida

oro perlato
pearl gold
or nacré
Perlgold
oro perlado



Him & Her Lucida

rosso arancio chiaro
bright red orange
orangé rouge clair
Hellrotorange
rojo claro aranjado



Him & Her Lucida

violetto perlato
pearl violet
violet nacré
Perlviolett
violeta perlado

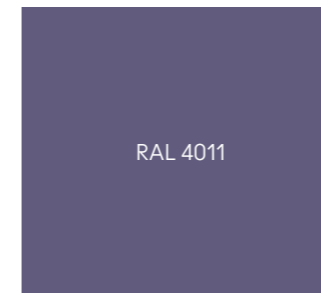

Him & Her Lucida

blu oltremare
ultramarine blu
bleu outremer
Ultramarinblau
azul ultramar



Him & Her Lucida

blu acqua
water blue
bleu d'eau
Wasserblau
azul agua



Him & Her Lucida

blu notte perlato
pearl night blue
bleu nuit nacré
Perlnachtblau
azul noche perlado



Him & Her Lucida

Fenix, Rattan e Midollino

/ Fenix, Rattan and Natural Wicker

Fenix NTM® nero ingo 0720
RAL Design 000 25 00
Pantone P 179-16 C
Ncs S 8500-N

Fenix NTM® bianco kos 0032
RAL 9016
Pantone P 1-9 C
Ncs S 0500-N

Fenix NTA® Acciaio Hamilton
Fenix NTA® Hamilton Steel
Fenix NTA® Acier Hamilton
Fenix NTA® Hamilton Stahl
Fenix NTA® Acero Hamilton



Bolero / Flower /
Lazy Susan / Tango

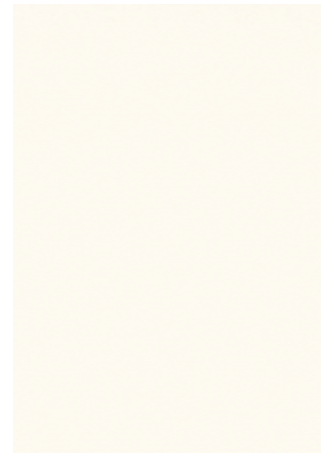

Bolero / Flower / Tango

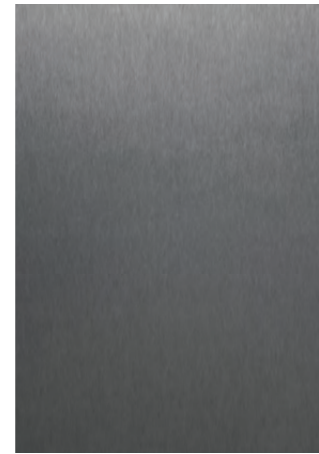

Bolero / Tango

midollino naturale
natural wicker
osier naturel
Peddigrohr natur
mimbre natural

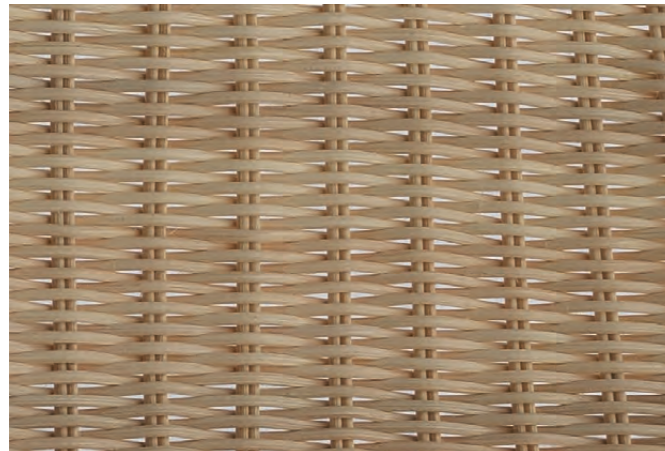

Bar / Charlotte / Sin

rattan
rattan
rotin
Rattan
ratán



Raphia Rattan / Raphia Rocking

Cuoio Pieno Fiore ed Ecopelle

/ Hard Leather Grade 1 and Faux Leather

cuoio pieno fiore naturale
hard leather grade 1 natural
cuir pleine fleur naturel
Kernleder Natur
cuero natural



Pablita / Tout le Jour

cuoio pieno fiore nero
hard leather grade 1 black
cuir pleine fleur noir
Kernleder Schwarz
cuero negro

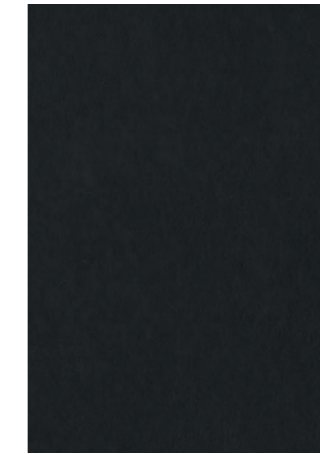

Pablita / Tout le Jour

cuoio pieno fiore grigio talpa
hard leather grade 1 taupe
cuir pleine fleur taupe
Kernleder Taupe
cuero gris raton

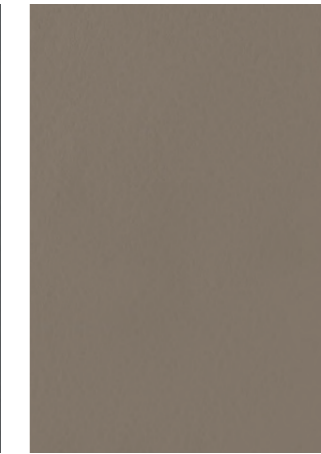

Pablita / Tout le Jour

cuoio pieno fiore testa di moro
hard leather grade 1 brown
cuir pleine fleur brun foncé
Kernleder Dunkelbrown
cuero testa di moro

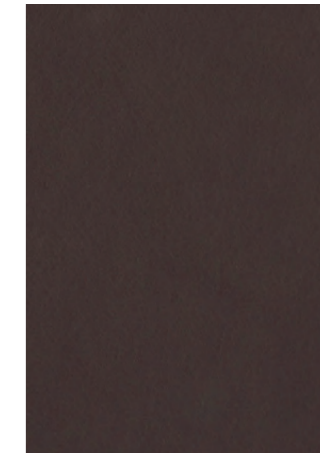

Pablita / Tout le Jour

Ecopelle
Faux Leather
Similcuir
Kunstleder
Ecopiel



Network

Ecopelle
Faux Leather
Similcuir
Kunstleder
Ecopiel

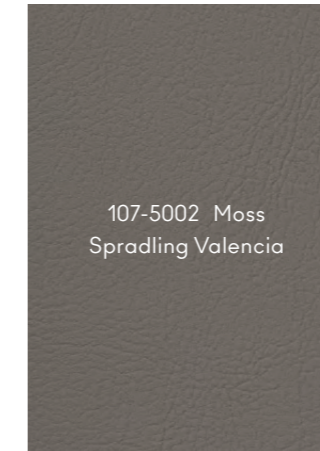

Network

Ecopelle
Faux Leather
Similcuir
Kunstleder
Ecopiel



Network

Ecopelle
Faux Leather
Similcuir
Kunstleder
Ecopiel

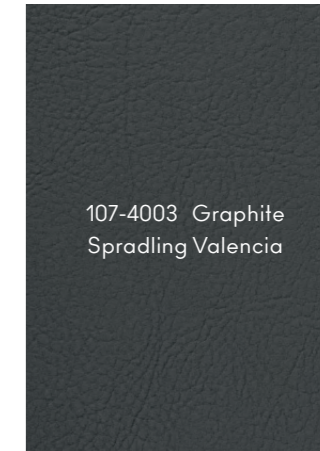

Network

nero
black
noir
Schwarz
negro



Lepel

bianco
white
blanc
Weiß
blanco

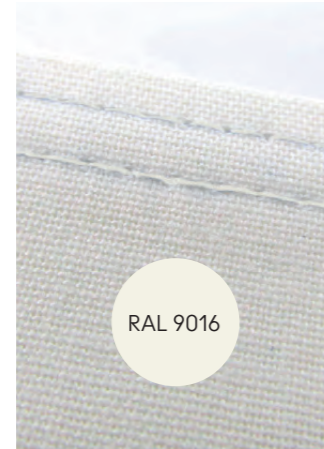

Lepel

polvere
dusty grey
gris poussière
Staubgrau
gris polvo



Lepel

giallo navone
colza yellow
jaune colza
Rapsgelb
amarillo colza



Lepel

rosso arancio chiaro
bright red orange
orangé rouge clair
Hellrotorange
rojo claro anaranjado



Lepel

rosso rubino
ruby red
rouge rubis
Rubinrot
rojo rubí



Lepel

rosa chiaro
light pink
rose clair
Hellrosa
rosa claro



Lepel

marrone noce
nut brown
brun noisette
Nussbraun
pardo nuez



Lepel

blu cobalto
cobalt blue
bleu cobalt
Kobaltblau
azul cobalto



Lepel

blu traffico
traffic blue
bleu signalisation
Verkehrsblau
azul tráfico



Lepel

verde brillante
luminous green
vert brillant
Leuchtgrün
verde brillante



Lepel

verde canna
reed green
vert jonc
Schilfgrün
verde caña



Lepel

lana lampone
raspberry red wool
laine rouge framboise
Himbeerrot Wolle
lana rojo frambuesa

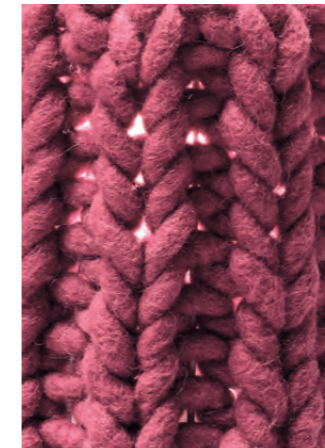

Granny

lana bianco ecrù
pure white wool
laine blanc pur
Reinweiß Wolle
lana blanco puro



Granny

lana grigio chiaro
light grey wool
laine gris clair
Lichtgrau Wolle
lana gris luminoso



Granny

Schede tecniche
Technical sheets
Fiches techniques
Technische Datenblätter
Fichas técnicas

Outdoor protetto

Prodotto adatto ad ambienti esterni protetti (es. verande coperte). Non adatto ad ambienti con presenza di pioggia, nebbia, rugiada o umidità persistente. È necessario il ricovero in area chiusa durante la notte. I prodotti realizzati con materiali naturali sono comunque soggetti a deterioramento.

Protected outdoor

Protected product suitable for protected outdoor areas (e.g. covered verandas). Not suitable for environments with rain, fog, dew or persistent humidity. Shelter in a closed area is necessary overnight. Products made from natural materials are however subject to deterioration.

Outdoor protégé

Produit adapté aux extérieurs protégés (par ex. vérandas couvertes). Ne convient pas aux environnements avec pluie, brouillard, rosée ou humidité persistante. Il est nécessaire de le rentrer dans une zone fermée pendant la nuit. Les produits fabriqués à partir de matériaux naturels peuvent, quoi qu'il en soit, se détériorer.

Geschützte Außenbereiche

Produkt, geeignet für geschützte Außenbereiche. Nicht geeignet für Umgebungen, die anhaltendem Regen, Nebel, Tau oder Feuchtigkeit ausgesetzt sind. Für die Nacht muss das Produkt in einen geschlossenen Bereich verlegt werden. Natürlichen Materialien unterliegen der Gefahr beschädigt zu werden.

Outdoor protegido

Producto apto para espacios externos protegidos (p. ej., verandas cubiertas). No apto para entornos con lluvia, niebla, rocío o humedad persistentes. Debe conservarse en lugar cerrado durante la noche. En todo caso, los productos realizados con materiales naturales están sujetos a deterioro.

Pioggia

Prodotto adatto ad ambienti esterni con precipitazioni atmosferiche normali. In caso di pioggia persistente è necessario il ricovero in area protetta. I prodotti realizzati con materiali naturali sono comunque soggetti a deterioramento.

Rain

Product suitable for outdoor environments with normal atmospheric precipitation. In case of persistent rain, shelter in a protected area is necessary. Products made from natural materials are however subject to deterioration.

Pluie

Produit adapté aux environnements extérieurs avec précipitations normales. En cas de pluie persistante, il est nécessaire de le rentrer dans une zone protégée. Les matériaux naturels peuvent, quoi qu'il en soit, se détériorer.

Regen

Das Produkt ist für Außenbereiche mit normalem Niederschlag geeignet. Bei anhaltendem Regen ist es notwendig, das Produkt in einen geschützten Bereich zu verlegen. Natürlichen Materialien unterliegen der Gefahr beschädigt zu werden.

Lluvia

Producto apto para espacios externos con precipitaciones normales. En caso de lluvia persistente se debe conservar en un área protegida. En todo caso, los productos realizados con materiales naturales están sujetos a deterioro.

Salsedine

Prodotto adatto ad aree marittime o con presenza di nebbia salina. Lavare frequentemente.

Seaside

Product suitable for sea areas or with salt spray. Wash frequently.

Bord de mer

Produit adapté aux zones maritimes ou en présence de brouillard salin. Laver fréquemment.

Am Meer

Für die Verwendung in Meernähe oder in Salznebel ausgesetzten Bereiche geeignet. Häufig waschen.

Orilla del mar

Producto apto para áreas marítimas con presencia de nieblas salinas. Lavar con frecuencia.

Impilabile

Prodotto realizzato per poter essere impilato.

Stackable

Product designed to be stacked.

Empilable

Produit conçu pour être empilé.

Stapelbar

Das Produkt ist zum Stapeln geeignet.

Apilable

Producto diseñado para ser apilado.

Basamento metallico per madie e cassettiere

Metal bases for sideboards and chest of drawers

Pieds métalliques pour buffets et commodes

Metallbasis für Sideboards und Schubladenelementen

Patas metálicas para aparadores y cajoneras

Minimal Design (MD)

> metallo nero
bianco

Minimal Design (MD)

> metal black
white

Minimal Design (MD)

> métal noir
blanc

Minimal Design (MD)

> Metall Schwarz
Weiß

Minimal Design (MD)

> metal negro
blanco

Mid-Century Modern (MCM)

> metallo brunito

Mid-Century Modern (MCM)

> burnished metal

Mid-Century Modern (MCM)

> metal bruni

Mid-Century Modern (MCM)

> brüniertes Metall

Mid-Century Modern (MCM)

> metal bruñido

	Madie o cassettiere Sideboards or chests of drawers Buffets ou commodes Sideboards oder Schubladen Aparadores o cajoneras	Lunghezza del mobile Storage unit length Longueur de meuble Behälter Länge Longitud del mueble
H 16 cm / 6.3"	Anish / ComRi / Polka Dots	128 cm / 50.4"
 MD	Carlos / Leon / Spectro	144 cm / 56.7"
 MCM	Anish / Carlos / ComRi / Leon / Not Riddled Polka Dots / Riddled Front / Spectro / Tide	192 cm / 75.6"
	Carlos / Leon / Spectro / Tide	240 cm / 94.5"

H 32 cm / 12.6"	Anish / ComRi / Polka Dots	128 cm / 50.4"
 MD	Carlos / Leon / Spectro	144 cm / 56.7"
	Anish / Carlos / ComRi / Leon / Not Riddled Polka Dots / Riddled Front / Spectro / Tide	192 cm / 75.6"
	Carlos / Leon / Spectro / Tide	240 cm / 94.6"

Ripiani

› laccato lucido
o laccato opaco
nero
bianco
polvere
beige
rosso vino
bruno
grafite

Shelves

› glossy lacquered
or matt lacquered
black
white
dusty grey
beige grey
wine red
brown grey
graphite

Étagères

› laqué brillant
ou laqué mat
noir
blanc
gris poussière
gris beige
rouge vin
gris brun
graphite

Einlegenböden

› glänzend lackiert
oder matt lackiert
Schwarz
Weiß
Staubgrau
Beigegrau
Weinrot
Braungrau
Graphit

Estantes

› lacado brillante
o lacado opaco
negro
blanco
gris polvo
gris beige
rojo vino
gris parduzco
grafito

Montanti

› noce canaletto
massello

Uprights

› solid walnut

Montants

› noyer massif

Pfosten

› Massiv Nussholz

Montantes

› nogal macizo

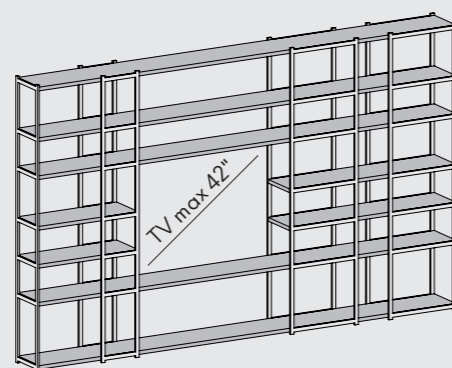
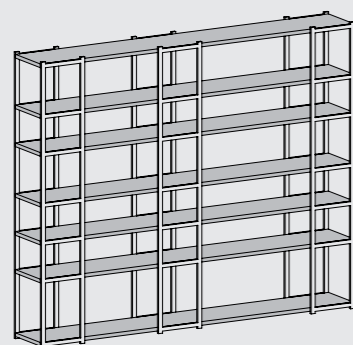
Esempidi composizioneExamplesof compositionExemplesde compositionBeispielevon KompositionEjemplosde composiciónProfondità

› 34.5 cm

Depth

› 34.5 cm / 13.5"

Profondeur

› 34.5 cm

Tiefe

› 34.5 cm

Profundidad

› 34.5 cm

Altezza

› 218 cm

Height

› 218 cm / 85.8"

Hauteur

› 218 cm

Hohe

› 218 cm

Altura

› 218 cm

Modularità

La libreria può avere infinite combinazioni considerando i seguenti moduli:

› 26 cm
› 32 cm
› 52 cm
› 57.5 cm
› 64 cm
› 80 cm
› 128 cm (porta TV)

Modularity

The library can have endless combinations considering the following modules:

› 26 cm / 10.2"
› 32 cm / 12.6"
› 52 cm / 20.5"
› 57.5 cm / 22.6"
› 64 cm / 25.2"
› 80 cm / 31.5"
› 128 cm / 50.4" (TV stand)

Modularité

La bibliothèque peut avoir multiple combinaisons en utilisant les modules suivants:

› 26 cm
› 32 cm
› 52 cm
› 57.5 cm
› 64 cm
› 80 cm
› 128 cm (meubles TV)

Modulbauweise

Das Bücherregale kann viele Kombinationen haben, wenn man die folgenden Module betrachtet:

› 26 cm
› 32 cm
› 52 cm
› 57.5 cm
› 64 cm
› 80 cm
› 128 cm (TV-Träger)

Modularidad

La biblioteca puede tener múltiples combinaciones utilizando los siguientes módulos:

› 26 cm
› 32 cm
› 52 cm
› 57.5 cm
› 64 cm
› 80 cm
› 128 cm (muebles TV)

Per maggiori informazioni vedere listino.

For more info, please see price list.

Pour plus d'informations, voir la liste des prix.

Weitere Infos in der Preisliste

Para más información, consulte la tarifa.

Struttura

› metallo
bianco
beige

Structure

› metal
white
beige grey

Structure

› métal
blanc
gris beige

Struktur

› Metall
Weiß
Beigegrau

Estructura

› metal
blanco
gris beige

Nota

Gli elementi possono essere appoggiati a terra o fissati a parete. Il pannello di fondo nasconde le viti di fissaggio.

Notice

The elements can be placed on the ground or fixed to the wall. The bottom panel hides the fixing screws.

Avertissement

Les éléments peuvent être posés au sol ou fixés au mur. Le panneau inférieur cache les vis de fixation.

Anmerkungen

Die Elemente können auf dem Boden oder an der Wand befestigt werden. Die Bödenplatte versteckt die Schrauben.

Aviso

Los elementos pueden colocarse en el suelo o fijarse a la pared. El panel inferior oculta los tornillos de fijación.

Small
40
15.7"
20
7.9"

Medium
60
23.6"
20
7.9"

Large
40
15.7"
40
15.7"

Profondità

› 30 cm
› 20 cm

Depth

› 30 cm / 11.8"
› 20 cm / 17.9"

Profondeur

› 30 cm
› 20 cm

Tiefe

› 30 cm
› 20 cm

Profundidad

› 30 cm
› 20 cm

<u>Scocca</u> › laccato lucido o laccato opaco nero bianco polvere beige rosso vino bruno grafite	<u>Body</u> › glossy lacquered or matt lacquered black white dusty grey beige grey wine red brown grey graphite	<u>Corps</u> › laqué brillant ou laqué mat noir blanc gris poussière gris beige rouge vin gris brun graphite	<u>Korpus</u> › glänzend lackiert oder matt lackiert Schwarz Weiß Staubgrau Beigegrau Weinrot Braungrau Graphit	<u>Cuerpo</u> › lacado brillante o lacado opaco negro blanco gris polvo gris beige rojo vino gris parduzco grafito
› faggio moca	› mocha beech	› hêtre moka	› Buche Mokka	› haya moca
<u>Frontale cassetti</u> › laccato lucido o laccato opaco nero bianco polvere beige rosso vino bruno grafite	<u>Front drawers</u> › glossy lacquered or matt lacquered black white dusty grey beige grey wine red brown grey graphite	<u>Façade de tiroirs</u> › laqué brillant ou laqué mat noir blanc gris poussière gris beige rouge vin gris brun graphite	<u>Schubladenfront</u> › glänzend lackiert oder matt lackiert Schwarz Weiß Staubgrau Beigegrau Weinrot Braungrau Graphit	<u>Frontal de cajones</u> › lacado brillante o lacado opaco negro blanco gris gris beige rojo vino gris parduzco grafito
› noce canaletto	› walnut	› noyer	› Nussbaum	› nogal
<u>Fianco cassetti</u> › alluminio	<u>Drawer sides</u> › aluminium	<u>Côté des tiroirs</u> › aluminium	<u>Schubladenseite</u> › Aluminium	<u>Laterales de cajones</u> › aluminio
<u>Optional</u> › basamenti MCM (H16 cm) MD (H16 / H32 cm)	<u>Optional</u> › metal bases MCM (H16 cm) MD (H16 / H32 cm)	<u>Optionnel</u> › pieds métalliques MCM (H16 cm) MD (H16 / H32 cm)	<u>Optional</u> › Metallbasis MCM (H16 cm) MD (H16 / H32 cm)	<u>Opcional</u> › patas metálicas MCM (H16 cm) MD (H16 / H32 cm)
<u>Nota</u> Di serie piedini H2 cm regolabili.	<u>Notice</u> Adjustable H2 cm feet as standard.	<u>Avertissement</u> Pieds réglables H2 cm en standard.	<u>Anmerkungen</u> Regulierbare Standardfüße H2cm.	<u>Aviso</u> Pies regulables de H2 cm de serie.

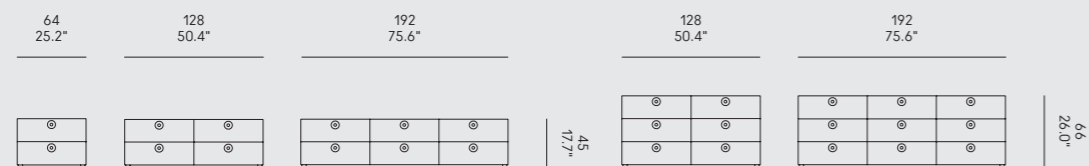

<u>Profondità</u> › 50 cm	<u>Depth</u> › 50 cm / 19.7"	<u>Profondeur</u> › 50 cm	<u>Tiefe</u> › 50 cm	<u>Profundidad</u> › 50 cm
------------------------------	---------------------------------	------------------------------	-------------------------	-------------------------------

<u>Scocca</u> › laccato lucido o laccato opaco nero bianco polvere beige rosso vino bruno grafite	<u>Body</u> › glossy lacquered or matt lacquered black white dusty grey beige grey wine red brown grey graphite	<u>Corps</u> › laqué brillant ou laqué mat noir blanc gris poussière gris beige rouge vin gris brun graphite	<u>Korpus</u> › glänzend lackiert oder matt lackiert Schwarz Weiß Staubgrau Beigegrau Weinrot Braungrau Graphit	<u>Cuerpo</u> › lacado brillante o lacado opaco negro blanco gris polvo gris beige rojo vino gris parduzco grafito
› faggio moca	› mocha beech	› hêtre moka	› Buche Mokka	› haya moca
<u>Ante</u> › laccato lucido o laccato opaco nero bianco polvere beige rosso vino bruno grafite	<u>Doors</u> › glossy lacquered or matt lacquered black white dusty grey beige grey wine red brown grey graphite	<u>Portes</u> › laqué brillant ou laqué mat noir blanc gris poussière gris beige rouge vin gris brun graphite	<u>Türen</u> › glänzend lackiert oder matt lackiert Schwarz Weiß Staubgrau Beigegrau Weinrot Braungrau Graphit	<u>Puertas</u> › lacado brillante o lacado opaco negro blanco gris polvo gris beige rojo vino gris parduzco grafito
› noce canaletto	› walnut	› noyer	› Nussbaum	› nogal
<u>Optional</u> › ripiani in legno	<u>Optional</u> › wooden shelves	<u>Optionnel</u> › étagères en bois	<u>Optional</u> › Holzregale	<u>Opcional</u> › baldas de madera
› basamenti MCM (H16 cm) MD (H16 / H32 cm)	› metal bases MCM (H16 cm) MD (H16 / H32 cm)	› pieds métalliques MCM (H16 cm) MD (H16 / H32 cm)	› Metallbasis MCM (H16 cm) MD (H16 / H32 cm)	› patas metálicas MCM (H16 cm) MD (H16 / H32 cm)
<u>Nota</u> Di serie ripiani in vetro temperato e piedini H2 cm regolabili.	<u>Notice</u> Tempered glass shelves and adjustable H2 cm feet as standard.	<u>Avertissement</u> Étagères en verre trempé et pieds réglables H2 cm en standard.	<u>Anmerkungen</u> Standard Temperglasregale und regulierbare Standardfüße H2cm.	<u>Aviso</u> Baldas de cristal templado y pies de H2 cm regulables de serie.

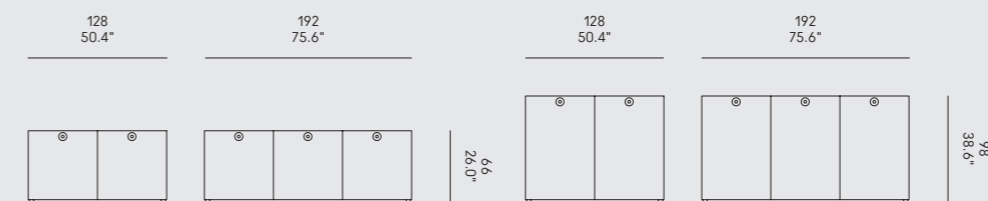

<u>Profondità</u> › 50 cm	<u>Depth</u> › 50 cm / 19.7"	<u>Profondeur</u> › 50 cm	<u>Tiefe</u> › 50 cm	<u>Profundidad</u> › 50 cm
------------------------------	---------------------------------	------------------------------	-------------------------	-------------------------------

Scocca e ripiani
 › metallo nero

Body and shelver
 › black metal

Corps et étagères
 › métal noir

Korpus und Böden
 › schwarzes Metall

Cuerpo y estantes
 › metal negro

Cornice
 › alluminio anodizzato

Frame
 › anodized aluminium

Cadre
 › aluminium anodisé

Rahmen
 › eloxiertes Aluminium

Marco
 › aluminio anodizado

Nota
 Montaggio a parete. Specchio con pellicola anti-infortunistica. Lo specchio è fisso. Un contenitore alle spalle dello specchio scorre esternamente a destra e a sinistra.

Notice
 Wall mounting. Mirror with safety film. Mirror is fixed. A container behind the mirror slides externally to the right and left.

Avertissement
 Montage mural. Miroir avec film de sécurité. Le miroir est fixe. Un conteneur derrière le miroir glisse vers l'extérieur à droite et à gauche.

Anmerkungen
 Wandmontage. Spiegel mit Sicherheitsfolie. Der Spiegel ist fixiert. Ein Behälter hinter dem Spiegel gleitet außen nach rechts und links.

Aviso
 Montaje a la pared. Espejo con película de seguridad. El espejo queda fijo. Un contenedor detrás del espejo se desliza externamente a la derecha y a la izquierda.

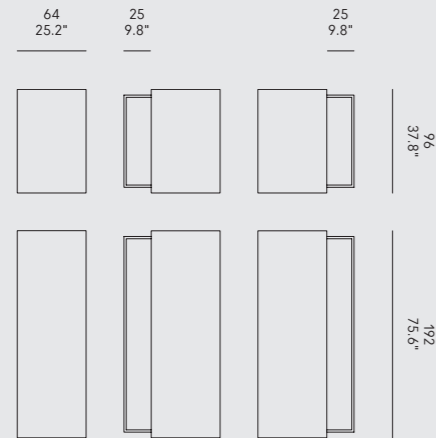

Profondità
 › 17 cm

Depth
 › 17 cm / 6.7"

Profondeur
 › 17 cm

Tiefe
 › 17 cm

Profundidad
 › 17 cm

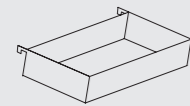

Ripiani dritti portaoggetti

Straight storage shelves

Étagères de rangement droites

Einlegeböden für die Lagerung

Repisas horizontales porta objetos

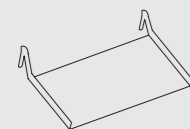

Ripiani inclinati per uso scarpiera

Inclined shelves for shoe rack use

Tablettes inclinées pour étagères à chaussures

Schrägbödenregale für Schuhe

Repisas inclinadas para zapatos

Scocca
 › laccato lucido o laccato opaco
 nero
 bianco
 polvere
 beige
 rosso vino
 bruno
 grafite

Body
 › glossy lacquered or matt lacquered
 black
 white
 dusty grey
 beige grey
 wine red
 brown grey
 graphite

Corps
 › laqué brillant ou laqué mat
 noir
 blanc
 gris poussière
 gris beige
 rouge vin
 gris brun
 graphite

› Korpus
 › glänzend lackiert oder matt lackiert
 Schwarz
 Weiß
 Staubgrau
 Beigegrü
 Weinrot
 Braungrau
 Graphit

Cuerpo
 › lacado brillante o lacado opaco
 negro
 blanco
 gris polvo
 beige
 rojo vino
 gris parduzco
 grafito

Nota
 Disponibile nelle versioni:
 › credenza (A)
 › armadio con ripiani (B)
 › armadio con bastone appendiabiti illuminato (C)

Notice
 Available in the following versions:
 › cupboard (A)
 › wardrobe with shelves (B)
 › wardrobe with illuminated clothes rail (C)

Avertissement
 Disponible en version:
 › buffet (A)
 › armoire avec étagères (B)
 › armoire avec tringle à linge éclairée (C)

Anmerkungen
 Erhältlich in die Versionen:
 › Kredenz (A)
 › Regalschrank (B)
 › Schrank mit beleuchteter Kleiderstange (C)

Aviso
 Disponible en versiones:
 › alacena (A)
 › armario con baldas (B)
 › armario con barra de confección iluminada (C)

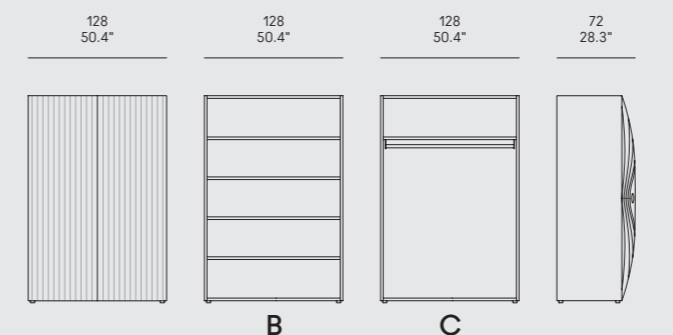
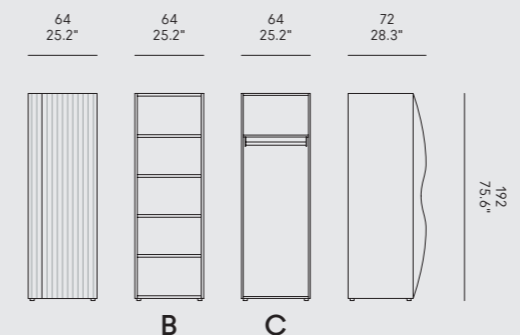
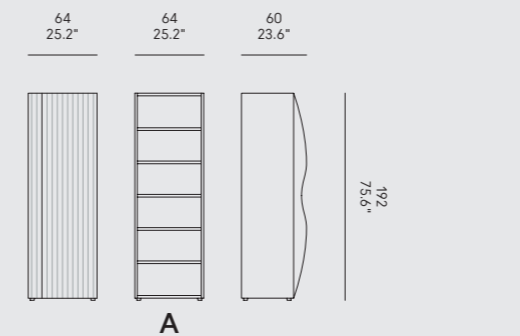

<u>Scocca</u> > laccato opaco o lucido bianco > faggio moca	<u>Body</u> > white matt or glossy lacquered > mocha beech	<u>Corps</u> > laqué mat ou brillant blanc > hêtre moka	<u>Korpus</u> > weiß matt oder glänzend lackiert > Buche Mokka	<u>Cuerpo</u> > lacado brillante o opaco blanco > haya moca
<u>Ante</u> > rovere termotrattato e HPL bianco	<u>Doors</u> > thermo-treated oak and white HPL	<u>Portes</u> > chêne thermotraité et HPL blanc	<u>Türen</u> > wärmebehandelte Eiche und HPL Weiß	<u>Puertas</u> > roble termotrattato y HPL blanco
<u>Optional</u> > ripiani in legno > basamenti MCM (H16 cm) MD (H16 / H32 cm)	<u>Optional</u> > wooden shelves > metal bases MCM (H16 cm) MD (H16 / H32 cm)	<u>Optionnel</u> > étagères en bois > pieds métalliques MCM (H16 cm) MD (H16 / H32 cm)	<u>Optional</u> > Holzregale > Metallbasis MCM (H16 cm) MD (H16 / H32 cm)	<u>Opcional</u> > baldas de madera > patas metálicas MCM (H16 cm) MD (H16 / H32 cm)
<u>Nota</u> Di serie ripiani in vetro temperato e piedini H2 cm regolabili.	<u>Notice</u> Tempered glass shelves and adjustable H2 cm feet as standard.	<u>Avertissement</u> Étagères en verre trempé et pieds réglables H2 cm en standard.	<u>Anmerkungen</u> Standard Temperglasregale und regulierbare Standardfüße H2 cm.	<u>Aviso</u> Baldas de cristal templado y pies de H2 cm regulables de serie.

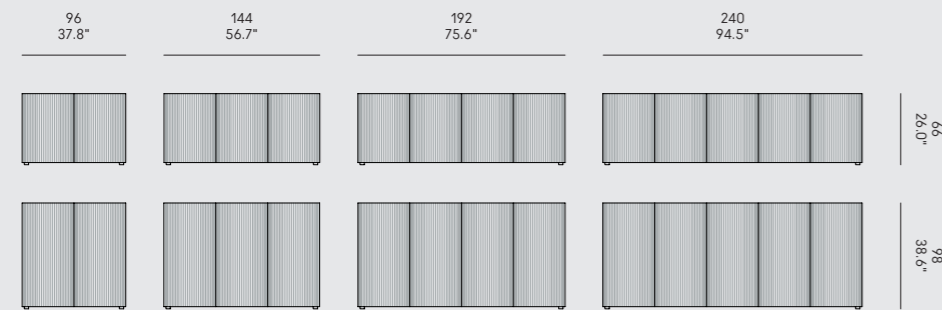

<u>Profondità</u> > 49 cm	<u>Depth</u> > 49 cm / 19.3"	<u>Profondeur</u> > 49 cm	<u>Tiefe</u> > 49 cm	<u>Profundidad</u> > 49 cm
------------------------------	---------------------------------	------------------------------	-------------------------	-------------------------------

<u>Struttura e frontali</u> > laccato lucido o laccato opaco nero bianco polvere beige rosso vino bruno grafite	<u>Structure and front</u> > glossy lacquered or matt lacquered black white dusty grey beige grey wine red brown grey graphite	<u>Structure et façades</u> > laqué brillant ou laqué mat noir blanc gris poussière gris beige rouge vin gris brun graphite	<u>Korpus und Front</u> > glänzend lackiert oder matt lackiert Schwarz Weiß Staubgrau Beigegrau Weinrot Braungrau Graphit	<u>Estructura y frontal</u> > lacado brillante o lacado opaco negro blanco gris polvo gris beige rojo vino gris parduzco grafito
<u>Portagioie</u> > multistrato in noce canaletto, mogano, ciliegio, rovere e frassino	<u>Jewelry drawer</u> > walnut, mahogany, cherry, oak and ash plywood	<u>Porte-bijoux</u> > contre-plaquè en noyer, acajou, cerisier, chêne et frêne	<u>Schmuckkästen</u> > Multiplex aus Nussbaum, Mahagoni, Kirsche, Eiche und Esche	<u>Portajoyas</u> > multicapas en nogal, caoba, cerezo, roble y fresno
<u>Fianco cassetti</u> > alluminio	<u>Drawer sides</u> > aluminium	<u>Côté des tiroirs</u> > aluminium	<u>Schubladenseite</u> > Aluminium	<u>Laterales de cajones</u> > aluminio
<u>Optional</u> > basamenti MCM (H16 cm) MD (H16 / H32 cm)	<u>Optional</u> > metal bases MCM (H16 cm) MD (H16 / H32 cm)	<u>Optionnel</u> > pieds métalliques MCM (H16 cm) MD (H16 / H32 cm)	<u>Optional</u> > Metallbasis MCM (H16 cm) MD (H16 / H32 cm)	<u>Opcional</u> > patas metálicas MCM (H16 cm) MD (H16 / H32 cm)
<u>Nota</u> Di serie piedini H2 cm regolabili.	<u>Notice</u> Adjustable H2 cm feet as standard.	<u>Avertissement</u> Pieds réglables H2 cm en standard.	<u>Anmerkungen</u> Regulierbare Standardfüße H2cm.	<u>Aviso</u> Pies regulables de H2 cm de serie.

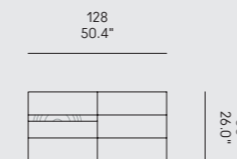

Disponibile con
3 cassetti + 1 anta
oppure 6 cassetti.

Available with
3 drawers + 1 door
or 6 drawers.

Disponibile avec
3 tiroirs + 1 porte
ou 6 tiroirs.

Mit 3 Schubladen + 1 Tür
oder mit 6 Schubladen
erhältlich.

Disponibile con
3 cajones + 1 puerta
o 6 cajones.

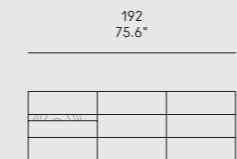

Disponibile con
3 cassetti + 2 ante
o 6 cassetti + 1 anta.

Available with
3 drawers + 2 doors
or 6 drawers + 1 door.

Disponibile avec
3 tiroirs + 2 portes
ou 6 tiroirs + 1 porte.

Mit 3 Schubladen + 2 Türen
oder mit 6 Schubladen
+ 1 Tür erhältlich.

Disponibile con
3 cajones + 2 puertas
o 6 cajones + 1 puerta.

<u>Profondità</u> > 50 cm	<u>Depth</u> > 50 cm / 19.7"	<u>Profondeur</u> > 50 cm	<u>Tiefe</u> > 50 cm	<u>Profundidad</u> > 50 cm
------------------------------	---------------------------------	------------------------------	-------------------------	-------------------------------

<u>Montanti</u> > metallo nero bianco	<u>Uprights</u> > metal black white	<u>Montants</u> > métal noir blanc	<u>Pfosten</u> > Metall Schwarz Weiß	<u>Montantes</u> > metal negro blanco
<u>Piedini e supporti</u> > plastica nero bianco	<u>Feet and supports</u> > plastic black white	<u>Pieds et supports</u> > plastique noir blanc	<u>Füße und Stützen</u> > Kunststoff Schwarz Weiß	<u>Pies y soportes</u> > plástico negro blanco
<u>Ripiani e contenitori</u> > melaminico bianco noce	<u>Shelves, cabinets and chest of drawers</u> > melamine white walnut	<u>Étagères et meubles de rangement</u> > mélamine blanc noyer	<u>Einlegenböden und Behälter</u> > Melamin Weiß Nussbaum	<u>Estantes y contenedores</u> > melamina blanco nogal

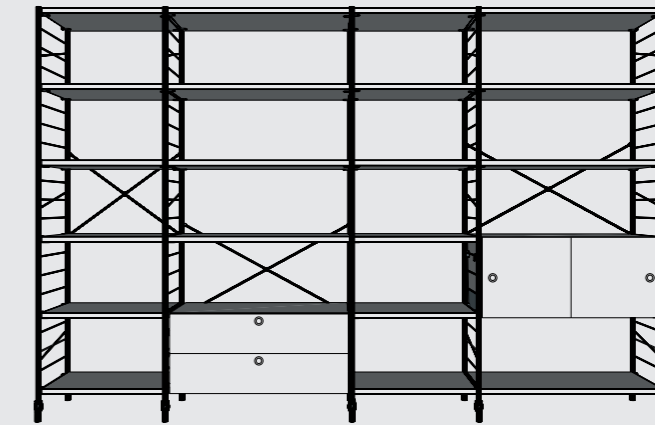

Esempio di composizione

Example of composition

Exemple de composition

Beispiel von Komposition

Ejemplo de composición

Profondità
> 33.5 cm

Depth
> 33.5 cm / 13.2"

Profondeur
> 33.5 cm

Tiefe
> 33.5 cm

Profundidad
> 33.5 cm

Altezza
> 77 cm
> 125 cm
> 163.5 cm
> 202 cm

Height
> 77 cm / 30.3"
> 125 cm / 49.2"
> 163.5 cm / 64.4"
> 202 cm / 79.5"

Hauteur
> 77 cm
> 125 cm
> 163.5 cm
> 202 cm

Hohe
> 77 cm
> 125 cm
> 163.5 cm
> 202 cm

Altura
> 77 cm
> 125 cm
> 163.5 cm
> 202 cm

Modularità
La libreria può avere infinite combinazioni considerando i seguenti moduli:
> 60 cm
> 90 cm

Modularity
The library can have endless combinations considering the following modules:
> 60 cm / 23.6"
> 90 cm / 35.4"

Modularité
La bibliothèque peut avoir multiple combinaisons en utilisant les modules suivants:
> 60 cm
> 90 cm

Modulbauweise
Das Bücherregal kann viele Kombinationen haben, wenn man die folgenden Module betrachtet:
> 60 cm
> 90 cm

Modularità
La biblioteca puede tener múltiples combinaciones utilizando los siguientes módulos:
> 60 cm
> 90 cm

Per maggiori informazioni vedere listino.

For more info, please see price list.

Pour plus d'informations, voir la liste des prix.

Weitere Infos in der Preisliste.

Para más información, consulte la tarifa.

<u>Montanti e accessori</u>	<u>Uprights and accessories</u>	<u>Montants et accessoires</u>	<u>Pfosten und Zubehör</u>	<u>Montantes y accesorios</u>
> metallo bianco grigio	> metal white grey	> métal blanc gris	> Metall Weiß grau	> metal blanco gris
<u>Piedini e supporti</u> > plastica trasparente	<u>Feet and supports</u> > transparent plastic	<u>Pieds et supports</u> > plastique transparent	<u>Füße und Stützen</u> > transparenter Kunststoff	<u>Pies y soportes</u> > plástico transparente
<u>Ripiani e contenitori</u> > melaminico bianco grigio	<u>Shelves, cabinets and chest of drawers</u> > melamine white grey	<u>Étagères et meubles de rangement</u> > mélamine blanc gris	<u>Einlegenböden und Behälter</u> > Melamin Weiß Grau	<u>Estantes y contenedores</u> > melaminico blanco gris
> lamiera di metallo microforato bianco grigio	> microperforated metal sheet white grey	> tôle microperforée blanc gris	> mikroperforierte Blech Weiß grau	> lámina de metal microperforada blanco gris

Esempio di composizione

Example of composition

Exemple de composition

Beispiel von Komposition

Ejemplo de composición

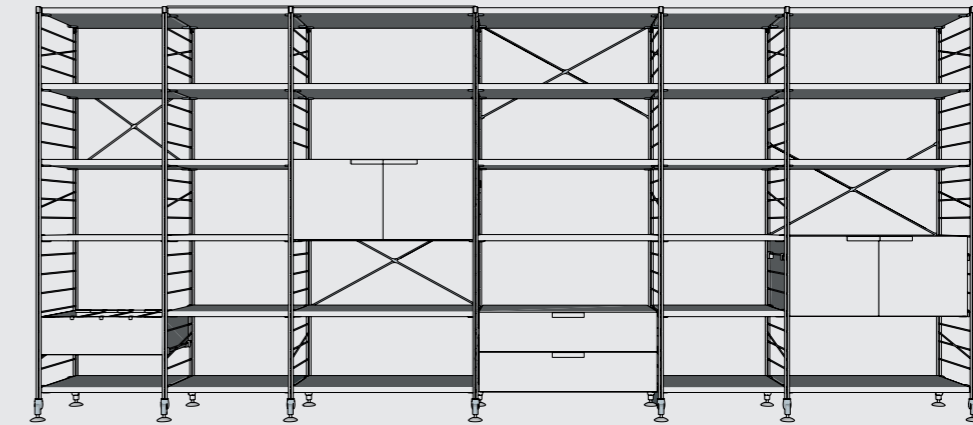

Profondità

- > 27 cm
- > 33.5 cm
- > 45.5 cm
- > 54 cm bifrontale

Depth

- > 127 cm / 0.6"
- > 33.5 cm / 13.2"
- > 45.5 cm / 17.9"
- > 54 cm / 21.3" two-sided

Profondeur

- > 27 cm
- > 33.5 cm
- > 45.5 cm
- > 54 cm double-face

Tiefe

- > 27 cm
- > 33.5 cm
- > 45.5 cm
- > 54 cm doppelseitig

Profundidad

- > 27 cm
- > 33.5 cm
- > 45.5 cm
- > 54 cm bifrontal

Altezza

- > 84 cm
- > 132 cm
- > 170 cm
- > 209 cm
- > 247 cm

Height

- > 84 cm / 33.0"
- > 132 cm / 51.9"
- > 170 cm / 66.9"
- > 209 cm / 82.3"
- > 247 cm / 97.2"

Hauteur

- > 84 cm
- > 132 cm
- > 170 cm
- > 209 cm
- > 247 cm

Hohe

- > 84 cm
- > 132 cm
- > 170 cm
- > 209 cm
- > 247 cm

Altura

- > 84 cm
- > 132 cm
- > 170 cm
- > 209 cm
- > 247 cm

Modularità

La libreria può avere infinite combinazioni considerando i seguenti moduli:

- > 60 cm
- > 90 cm

Modularity

The library can have endless combinations considering the following modules:

- > 60 cm / 23.6"
- > 90 cm / 35.4"

Modularité

La bibliothèque peut avoir multiple combinaisons en utilisant les modules suivants:

- > 60 cm
- > 90 cm

Modulbauweise

Das Bücherregal kann viele Kombinationen haben, wenn man die folgenden Module betrachtet:

- > 60 cm
- > 90 cm

Modularidad

La biblioteca puede tener múltiples combinaciones utilizando los siguientes módulos:

- > 60 cm
- > 90 cm

Per maggiori informazioni vedere listino.

For more info, please see price list.

Pour plus d'informations, voir la liste des prix.

Weitere Infos in der Preisliste.

Para más información, consulte la tarifa.

Finitura > laccato lucido o laccato opaco nero bianco polvere beige rosso vino bruno grafite	Finish > glossy lacquered or matt lacquered black white dusty grey beige grey wine red brown grey graphite	Finition > laqué brillant ou laqué mat noir blanc gris poussière gris beige rouge vin gris brun graphite	Ausführung > glänzend lackiert oder matt lackiert Schwarz Weiß Staubgrau Beigegrü Weinrot Braungrü Graphit	Acabado > lacado brillante o lacado opaco negro blanco gris polvo gris beige rojo vino gris parduzco grafito
Decor verticali > rovere naturale > noce canaletto	Vertical decorations > natural oak > walnut	Decorations verticaux > chêne naturel > noyer	Vertikale Dekorationen > Eiche Natur > Nussbaum	Decoraciones verticales > roble natural > nogal
Optional > ripiani in legno	Optional > wooden shelves	Optionnel > étagères en bois	Optional > Holzregale	Opcional > baldas de madera
> basamenti MCM (H16 cm) MD (H16 / H32 cm)	> metal bases MCM (H16 cm) MD (H16 / H32 cm)	> pieds métalliques MCM (H16 cm) MD (H16 / H32 cm)	> Metallbasis MCM (H16 cm) MD (H16 / H32 cm)	> patas metálicas MCM (H16 cm) MD (H16 / H32 cm)
Nota Di serie ripiani in vetro temperato e piedini H2 cm regolabili.	Notice Tempered glass shelves and adjustable H2 cm feet as standard.	Avertissement Étagères en verre trempé et pieds réglables H2 cm en standard.	Anmerkungen Standard Temperglasregale und regulierbare Standardfüße H2cm.	Aviso Baldas de cristal templado y pies de H2 cm regulables de serie.

Finitura > laccato lucido o laccato opaco nero bianco polvere beige rosso vino bruno grafite	Finish > glossy lacquered or matt lacquered black white dusty grey beige grey wine red brown grey graphite	Finition > laqué brillant ou laqué mat noir blanc gris poussière gris beige rouge vin gris brun graphite	Ausführung > glänzend lackiert oder matt lackiert Schwarz Weiß Staubgrü Beigegrü Weinrot Braungrü Graphit	Acabado > lacado brillante o lacado opaco negro blanco gris polvo gris beige rojo vino gris parduzco grafito
Optional > ripiani in legno	Optional > wooden shelves	Optionnel > étagères en bois	Optional > Holzregale	Opcional > baldas de madera
> basamenti MCM (H16 cm) MD (H16 / H32 cm)	> metal bases MCM (H16 cm) MD (H16 / H32 cm)	> pieds métalliques MCM (H16 cm) MD (H16 / H32 cm)	> Metallbasis MCM (H16 cm) MD (H16 / H32 cm)	> patas metálicas MCM (H16 cm) MD (H16 / H32 cm)
Nota Di serie ripiani in vetro temperato e piedini H2 cm regolabili.	Notice Tempered glass shelves and adjustable H2 cm feet as standard.	Avertissement Étagères en verre trempé et pieds réglables H2 cm en standard.	Anmerkungen Standard Temperglasregale und regulierbare Standardfüße H2cm.	Aviso Baldas de cristal templado y pies de H2 cm regulables de serie.

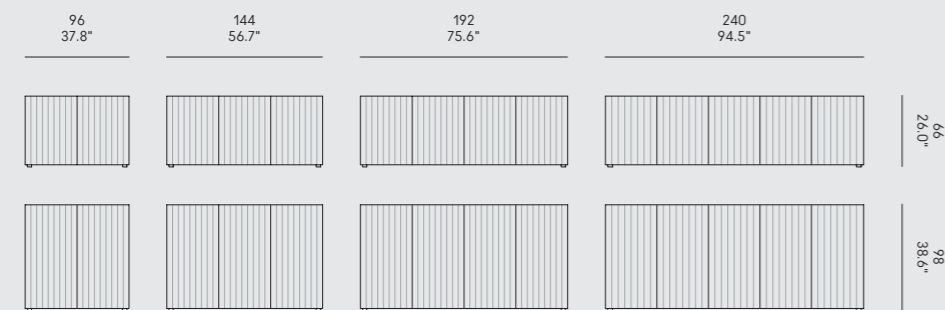

Profondità > 49 cm	Depth > 49 cm / 19.3"	Profondeur > 49 cm	Tiefe > 49 cm	Profundidad > 49 cm
------------------------------	---------------------------------	------------------------------	-------------------------	-------------------------------

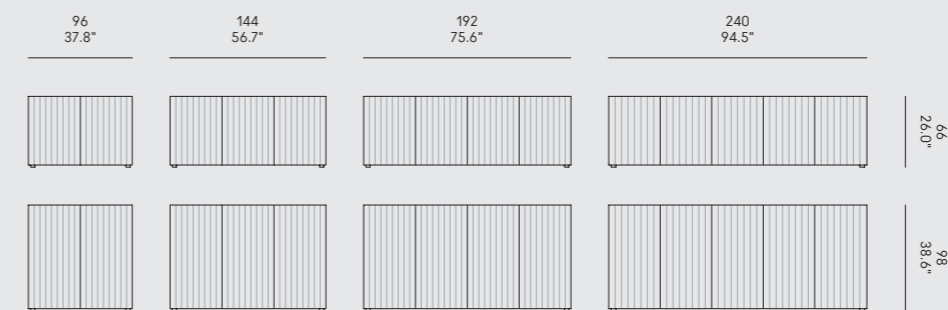

Profondità > 49 cm	Depth > 49 cm / 19.3"	Profondeur > 49 cm	Tiefe > 49 cm	Profundidad > 49 cm
------------------------------	---------------------------------	------------------------------	-------------------------	-------------------------------

Leon Moca

> scocca faggio moca
> ante ciliegio
e moca

Leon Mocha

> mocha beech body
> cherry and
mocha doors

Leon Moka

> corps hêtre moka
> portes cerisier
et moka

Leon Mokka

> Buche Mokka Korpus
> Kirsche und Mokka
Türen

Leon Moca

> cuerpo haya moca
> puertas cerezo
y moca

Leon Imbiancato

> scocca faggio
imbiancato
> ante faggio imbiancato
e bois blond

Leon Whitened

> whitened beech
body
> whitened and bois
blond beech doors

Leon Bianchi

> corps
hêtre blanchi
> portes hêtre blanchi
et bois blond

Leon Geweißt

> Buche geweißt
Korpus
> Buche geweißt und
Bois Blond Türen

Leon Blanqueado

> cuerpo
haya blanqueada
> puertas haya
blanqueada y bois blond

Leon Bois Blond

> scocca faggio
bois blond
> ante faggio bois blond
e imbiancato

Leon Bois blond

> bois blond beech
body
> bois blond and
whitened beech doors

Leon Bois blond

> corps
hêtre bois blond
> portes hêtre bois
blond et blanchi

Leon Bois Blond

> Buche Bois Blond
Korpus
> Buche Bois Blond
und geweißt Türen

Leon Bois blond

> cuerpo
haya bois blond
> puertas haya bois
blond y blanqueada

Optional

> ripiani in legno

Optional

> wooden shelves

Optionnel

> étagères en bois

Optional

> Holzregale

Opcional

> baldas de madera

> basamenti
MCM (H16 cm)
MD (H16 / H32 cm)

> metal bases
MCM (H16 cm)
MD (H16 / H32 cm)

> pieds métalliques
MCM (H16 cm)
MD (H16 / H32 cm)

> Metallbasis
MCM (H16 cm)
MD (H16 / H32 cm)

> patas metálicas
MCM (H16 cm)
MD (H16 / H32 cm)

Nota

Di serie ripiani in vetro
temperato e piedini
H2 cm regolabili.

Notice

Tempered glass shelves
and adjustable H2 cm
feet as standard.

Avertissement

Étagères en verre
trepé et pieds
réglables H2 cm
en standard.

Anmerkungen

Standard
Temperglasregale
und regulierbare
Standardfüße H2cm.

Aviso

Baldas de cristal
templado y pies
de H2 cm regulables
de serie.

La misura cm 96 x 66H
è disponibile solo nella
versione Leon Moca.

The size cm 96 x 66H
is only available in the
Leon Mocha version.

Le format cm 96 x 66H
n'est disponible que dans
la version Leon Moka.

Die Größe cm 96 x 66H
ist nur für die Version
Leon Mokka erhältlich.

El tamaño cm 96 x 66H
sólo está disponible en
versión Leon Moca.

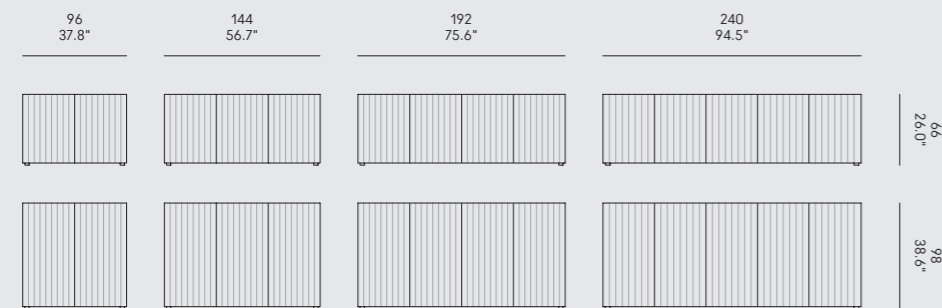
Profondità

> 49 cm

Depth

> 49 cm / 19.3"

Profondeur

> 49 cm

Tiefe

> 49 cm

Profundidad

> 49 cm

Struttura

> metallo verniciato
nero
bianco
bronzo antico

Structure

> painted metal
black
white
bronze antique

Structure

> métal verni
noir
blanc
bronze antique

Struktur

> beschichtetes Metall
Schwarz
Weiß
Vintage Bronze

Estructura

> metal pintado
negro
blanco
bronce antiguo

Ripiani

> ecopelle
Spradling Valencia
107-0001 praliné
107-1049 leinen
107-4003 grafite
107-5002 moss
(vedi pagina 165)

Shelves

> faux leather
Spradling Valencia
107-0001 praliné
107-1049 leinen
107-4003 grafite
107-5002 moss
(see page 165)

Étagères

> similcuir
Spradling Valencia
107-0001 praliné
107-1049 leinen
107-4003 grafite
107-5002 moss
(voir page 165)

Einlegenböden

> Kunstleder
Spradling Valencia
107-0001 Praliné
107-1049 Leinen
107-4003 Grafite
107-5002 Moss
(auf Seite 165)

Estantes

> ecopiel
Spradling Valencia
107-0001 praliné
107-1049 leinen
107-4003 grafite
107-5002 moss
(a página 165)

Nota

Include kit di unione per
più librerie.

Notice

Includes union kit for
multiple bookshelves.

Avertissement

Comprend un kit
d'union pour étagères
multiples.

Anmerkungen

Inklusive
Verbindungsset für
mehrere Bücherregale.

Aviso

Incluye kit de unión
para múltiples
estanterías.

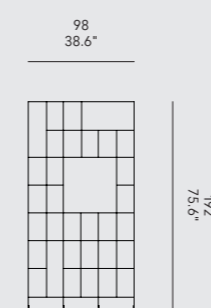
Profondità

> 28 cm

Depth

> 28 cm / 11.0"

Profondeur

> 28 cm

Tiefe

> 28 cm

Profundidad

> 28 cm

Scocca

› laccato lucido
o laccato opaco
nero
bianco
polvere
beige
rosso vino
bruno
grafite

Body

› glossy lacquered
or matt lacquered
black
white
dusty grey
beige grey
wine red
brown grey
graphite

Corps

› laqué brillant
ou laqué mat
noir
blanc
gris poussière
gris beige
rouge vin
gris brun
graphite

Korpus

› glänzend lackiert
oder matt lackiert
Schwarz
Weiß
Staubgrau
Beigegrü
Weinrot
Braungrü
Graphit

Cuerpo

› lacado brillante
o lacado opaco
negro
blanco
gris polvo
gris beige
rojo vino
gris parduzco
grafito

Ante e fianchi

› legno origami
in noce canaletto
brevetto HORM

Doors and sides

› origami wood
in walnut
HORM patent

Portes et cotés

› bois origami
en noyer
brevet HORM

Türen und Seiten

› Origami-Nussbaum
HORM-Patent

Puertas y lados

› madera origami
de nogal
patente HORM

Optional

› basamenti
MCM (H16 cm)
MD (H16 / H32 cm)

Optional

› metal bases
MCM (H16 cm)
MD (H16 / H32 cm)

Optionnel

› pieds métalliques
MCM (H16 cm)
MD (H16 / H32 cm)

Optional

› Metallbasis
MCM (H16 cm)
MD (H16 / H32 cm)

Opcional

› patas metálicas
MCM (H16 cm)
MD (H16 / H32 cm)

Nota

Di serie ripiani in vetro
temperato e piedini
H2 cm regolabili.

Notice

Tempered glass shelves
and adjustable H2 cm
feet as standard.

Avertissement

Étagères en verre
trempé et pieds
réglables H2 cm
en standard.

Anmerkungen

Standard
Temperglasregale
und regulierbare
Standardfüße H2cm.

Aviso

Baldas de cristal
templado y pies
de H2 cm regulables
de serie.

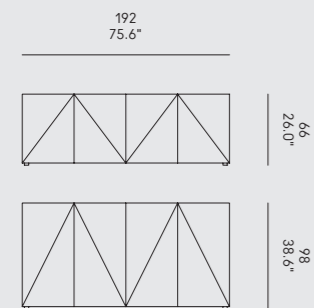
Profondità

› 50 cm

Depth

› 50 cm / 19.7"

Profondeur

› 50 cm

Tiefe

› 50 cm

Profundidad

› 50 cm

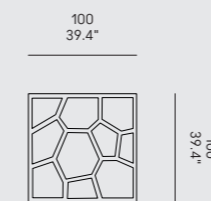
Profondità

› 35 cm

Depth

› 35 cm / 13.8"

Profondeur

› 35 cm

Tiefe

› 35 cm

Profundidad

› 35 cm



Finitura

› laccato lucido
o laccato opaco
nero
bianco
polvere
beige
rosso vino
bruno
grafite

Finish

› glossy lacquered
or matt lacquered
black
white
dusty grey
beige grey
wine red
brown grey
graphite

Finition

› laqué brillant
ou laqué mat
noir
blanc
gris poussière
gris beige
rouge vin
gris brun
graphite

Ausführung

› glänzend lackiert
oder matt lackiert
Schwarz
Weiß
Staubgrau
Beigegrü
Weinrot
Braungrü
Graphit

Estructura

› lacado brillante
o lacado opaco
negro
blanco
gris polvo
gris beige
rojo vino
gris parduzco
grafito

Optional

› basamenti
MCM (H16 cm)
MD (H16 / H32 cm)

Optional

› metal bases
MCM (H16 cm)
MD (H16 / H32 cm)

Optionnel

› pieds métalliques
MCM (H16 cm)
MD (H16 / H32 cm)

Optional

› Metallbasis
MCM (H16 cm)
MD (H16 / H32 cm)

Opcional

› patas metálicas
MCM (H16 cm)
MD (H16 / H32 cm)

Nota

Di serie ripiani in vetro temperato e piedini H2 cm regolabili. Illuminazione interna a LED.

Notice

Tempered glass shelves and adjustable H2 cm feet as standard. Indoor LED lighting.

Avertissement

Étagères en verre trempé et pieds réglables H2 cm en standard. Éclairage intérieur à LED.

Anmerkungen

Standard Temperglasregale und regulierbare Standardfüße H2cm. Innere LED-Beleuchtung.

Aviso

Baldas de cristal templado y pies de H2 cm regulables de serie. Iluminación LED para interiores.

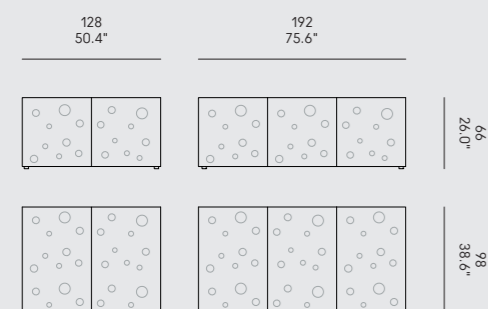
Profondità

› 49 cm

Depth

› 49 cm / 19.3"

Profondeur

› 49 cm

Tiefe

› 49 cm

Profundidad

› 49 cm

Ripiani

› frassino moca

› vetro extraclear

Shelves

› mocha ash

› extraclear glass

Étagères

› frêne moka

› verre extra-clair

Einlegenböden

› Esche Mokka

› extraklares Glas

Estantes

› fresno moca

› vidrio extraclaro

Montanti

› metallo crudo

Uprights

› hard metal

Montants

› métal cru

Pfosten

› Rohmetall

Montantes

› metal crudo

Profondità

› 40 cm

Depth

› 40 cm / 15.7"

Profondeur

› 49 cm

Tiefe

› 49 cm

Profundidad

› 49 cm

Scocca

› laccato lucido
o laccato opaco
nero
bianco
polvere
beige
rosso vino
bruno
grafite

Body

› glossy lacquered
or matt lacquered
black
white
dusty grey
beige grey
wine red
brown grey
graphite

Corps

› laqué brillant
ou laqué mat
noir
blanc
gris poussière
gris beige
rouge vin
gris brun
graphite

Korpus

› glänzend lackiert
oder matt lackiert
Schwarz
Weiß
Staubgrau
Beigegräu
Weinrot
Braungrau
Graphit

Cuerpo

› lacado brillante
o lacado opaco
negro
blanco
gris polvo
gris beige
rojo vino
gris parduzco
grafito

Ante e fianchi

› legno origami
in noce canaletto
brevetto HORM

Doors and sides

› origami wood
in walnut
HORM patent

Portes et cotés

› bois origami
en noyer
brevet HORM

Türen und Seiten

› Origami-Nussbaum
HORM-Patent

Puertas y lados

› madera origami
de nogal
patente HORM

Optional

› basamenti
MCM (H16 cm)
MD (H16 / H32 cm)

Optional

› metal bases
MCM (H16 cm)
MD (H16 / H32 cm)

Optionnel

› pieds métalliques
MCM (H16 cm)
MD (H16 / H32 cm)

Optional

› Metallbasis
MCM (H16 cm)
MD (H16 / H32 cm)

Opcional

› patas metálicas
MCM (H16 cm)
MD (H16 / H32 cm)

Nota

Di serie ripiani in vetro temperato e piedini H2 cm regolabili. Illuminazione interna a LED.

Notice

Tempered glass shelves and adjustable H2 cm feet as standard. Indoor LED lighting.

Avertissement

Étagères en verre trempé et pieds réglables H2 cm en standard. Éclairage intérieur à LED.

Anmerkungen

Standard
Temperglasregale und regulierbare Standardfüße H2cm. Innere LED-Beleuchtung.

Aviso

Baldas de cristal templado y pies de H2 cm regulables de serie. Iluminación LED para interiores.

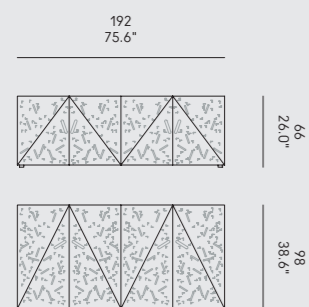
Profondità

› 50 cm

Depth

› 50 cm / 19.7"

Profondeur

› 50 cm

Tiefe

› 50 cm

Profundidad

› 50 cm

Robox

Metallo bianco
› corpo bianco
› cuore rosso

Robox

White metal
› white body
› red heart

Robox

Métal blanc
› corps blanc
› cœur rouge

Robox

weißes Metall
› weißer Körper
› rotes Herz

Robox

Metall blanco
› cuerpo blanco
› corazón rojo

Robox

Metallo grigio
› corpo grigio
› cuore rosso

Robox

Grey metal
› grey body
› red heart

Robox

Métal gris
› corps gris
› cœur rouge

Robox

graues Metall
› grauer Körper
› rotes Herz

Robox

Metall gris
› cuerpo gris
› corazón rojo

Robox

Metallo multicolor
› corpo bianco,
blu e giallo
› cuore rosso

Robox

Multicolor metal
› white blue
and yellow body
› red heart

Robox

Métal multicolor
› corps blanc,
bleu et jaune
› cœur rouge

Robox

Multicolor Metall
› weißer, blauer
und gelber Körper
› rotes Herz

Robox

Metall multicolor
› cuerpo blanco,
azul y amarillo
› corazón rojo

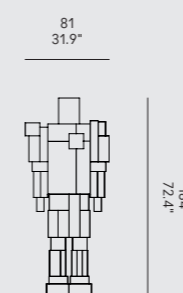
Profondità

› 30 cm

Depth

› 30 cm / 11.8"

Profondeur

› 30 cm

Tiefe

› 30 cm

Profundidad

› 30 cm

Torniti

› legno massello
noce e ontano

Uprights

› solid wood
walnut and alder

Montants

› bois massif
noyer et aulne

Gedrehte Stäbe

› Massivholz
Nussbaum und Erle

Montantes

› madera maciza
nogal y aliso

Ripiani

› MDF impiallacciato
con alluminio finitura
specchio

Shelves

› MDF veneered with
aluminium mirror finish

Étagères

› MDF plaqué
aluminium brillant

Einlegenböden

› MDF Platte mit
Aluminium-Spiegelung

Estantes

› MDF enchapado con
acabado de aluminio
espejo

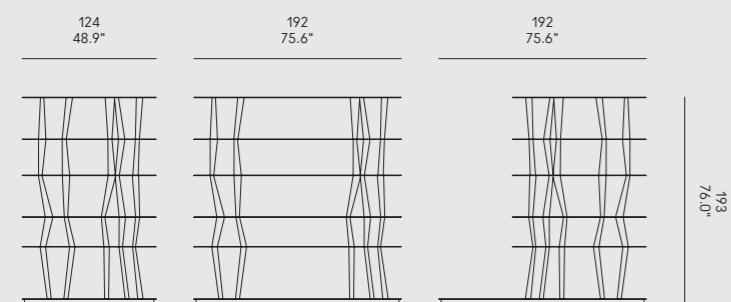

Profondità
› 48 cm

Depth
› 48 cm / 18.9"

Profondeur
› 48 cm

Tiefe
› 48 cm

Profundidad
› 48 cm

Torniti

› legno massello
noce e ontano

Uprights

› solid wood
walnut and alder

Montants

› bois massif
noyer et aulne

Gedrehte Stäbe

› Massivholz
Nussbaum und Erle

Montantes

› madera maciza
nogal y aliso

Ripiani

› vetro
trasparente
fumè
bronzato

Shelves

› glass
crytal clear
smoked
bronzed

Étagères

› verre
transparent
fumé
bronzé

Einlegenböden

› Glas
transparent
rauchfarbig
bronziert

Estantes

› vidrio
transparente
ahumado
bronceado

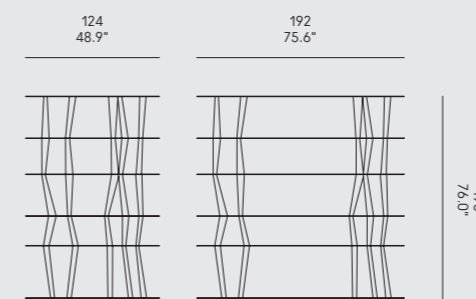
Ripiani

› trasparente

Shelves

› clear

Étagères

› transparent

Einlegenböden

› transparent

Estantes

› transparente

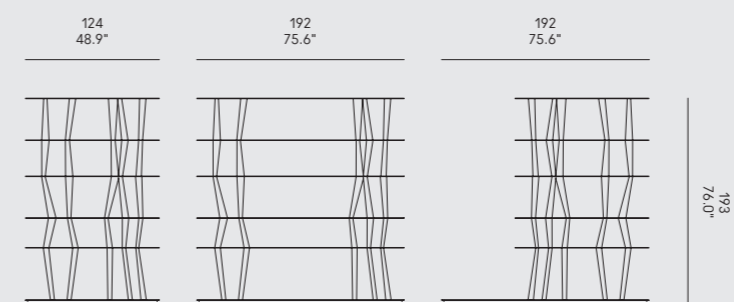
Ripiani

› fumè
› bronzato

Shelves

› smoky
› bronzed

Étagères

› fumé
› bronzé

Einlegenböden

› rauchfarbig
› bronziert

Estantes

› ahumado
› bronceado

Profondità
› 48 cm

Depth
› 48 cm / 18.9"

Profondeur
› 48 cm

Tiefe
› 48 cm

Profundidad
› 48 cm

<u>Finitura</u> › laccato opaco nero bianco polvere beige rosso vino bruno grafite	<u>Finish</u> › matt lacquered black white dusty grey beige grey wine red brown grey graphite	<u>Finition</u> › laqué mat noir blanc gris poussière gris beige rouge vin gris brun graphite	<u>Ausführung</u> › matt lackiert Schwarz Weiß Staubgrau Beigegrü Weinrot Braungrü Graphit	<u>Acabado</u> › lacado opaco negro blanco gris polvo gris beige rojo vino gris parduzco grafito
--	---	---	--	--

<u>Montanti</u> › laccato opaco bianco › noce canaletto	<u>Uprights</u> › white matt lacquered › walnut	<u>Montants</u> › laqué mat blanc › noyer	<u>Pfosten</u> › weiß matt lackiert › Nussbaum	<u>Montantes</u> › lacado opaco blanco › nogal
<u>Ripiani</u> › laccato opaco bianco	<u>Shelves</u> › white matt lacquered	<u>Étagères</u> › laqué mat blanc	<u>Einlegenböden</u> › weiß matt lackiert	<u>Estantes</u> › lacado opaco blanco

<u>Nota</u> In fase di montaggio, le due colonnine possono essere accostati a 60, 90 o 120 gradi tra loro.	<u>Notice</u> During assembly, the two columns can be combined at 60, 90 or 120 degrees between them.	<u>Avertissement</u> Lors du montage, les deux colonnes peuvent être combinées à 60, 90 ou 120 degrés entre elles.	<u>Anmerkungen</u> Bei der Montage können die beiden Säulen in einem Abstand von 60, 90 oder 120 Grad kombiniert werden.	<u>Aviso</u> Durante el montaje, las dos columnas pueden combinarse a 60, 90 o 120 grados entre ellas.
---	--	---	---	---

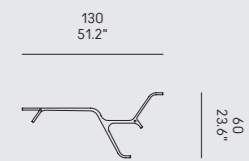

<u>Profondità</u> › 21 cm	<u>Depth</u> › 21 cm / 8.3"	<u>Profondeur</u> › 21 cm	<u>Tiefe</u> › 21 cm	<u>Profundidad</u> › 21 cm
------------------------------	--------------------------------	------------------------------	-------------------------	-------------------------------

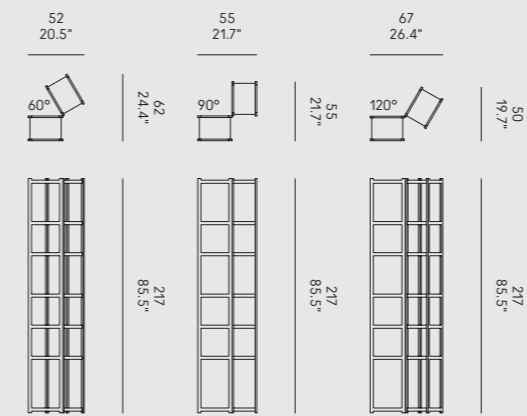

<u>Dimensione ripiano</u> › 20 x 32 cm	<u>Shelf size</u> › 20 x 32 cm / 7.9" x 12.6"	<u>Mesure d'étagère</u> › 20 x 32 cm	<u>Einlegenböden Größe</u> › 20 x 32 cm	<u>Tamaño del estante</u> › 20 x 32 cm
---	--	---	--	---

Pannelli

> laccato lucido
o laccato opaco
nero
bianco
polvere
beige
rosso vino
bruno
grafite

Panels

> glossy lacquered
or matt lacquered
black
white
dusty grey
beige grey
wine red
brown grey
graphite

Panneaux

> laqué brillant
ou laqué mat
noir
blanc
gris poussière
gris beige
rouge vin
gris brun
graphite

Panels

> glänzend lackiert
oder matt lackiert
Schwarz
Weiß
Staubgrau
Beigegrau
Weinrot
Braungrau
Graphit

Paneles

> lacado brillante
o lacado opaco
negro
blanco
gris polvo
gris beige
rojo vino
gris parduzco
grafito

Telaio e
ripiano interno

> rovere naturale
> rovere mocha

Frame and
internal shelf

> natural oak
> mocha oak

Cadre et étagère
intérieure

> chêne naturel
> chêne moka

Rahmen
und Innenregal

> Eiche Natur
> Eiche Mokka

Marco y
balda interior

> roble natural
> roble mocha

Nota

Nella configurazione standard il vano esterno dell'armadio è sempre a destra. Su richiesta può essere posizionato a sinistra.

Notice

In the standard configuration, the outer cabinet compartment is always on the right. On request, it can be positioned on the left.

Avertissement

Dans la configuration standard, le compartiment extérieur de l'armoire est toujours à droite. Sur demande, il peut être positionné à gauche.

Anmerkungen

In der Standard Konfiguration befindet sich das äußere Schrankfach immer rechts. Auf Anfrage kann auf der linken Seite platziert werden.

Aviso

En la configuración estándar, el compartimento exterior del armario está siempre a la derecha. A petición se puede posicionar a la izquierda.



Profondità
> 58 cm

Depth
> 58 cm / 22.8"

Profondeur
> 58 cm

Tiefe
> 58 cm

Profundidad
> 58 cm

Ripiani, schienali
e contenitori

> laccato lucido
o laccato opaco
nero
bianco
polvere
beige
rosso vino
bruno
grafite

Shelves, back panels
and boxes

> glossy lacquered
or matt lacquered
black
white
dusty grey
beige grey
wine red
brown grey
graphite

Etagères, dossiers
et meubles
de rangement

> laqué brillant
ou laqué mat
noir
blanc
gris poussière
gris beige
rouge vin
gris brun
graphite

Regale, Rücklehnen
und Behälter

> glänzend lackiert
oder matt lackiert
Schwarz
Weiß
Staubgrau
Beigegrau
Weinrot
Braungrau
Graphit

Estantes, respaldos
y contenedores

> lacado brillante
o lacado opaco
negro
blanco
gris polvo
gris beige
rojo vino
gris parduzco
grafito

Montanti

> rovere naturale
> rovere mocha

Uprights

> natural oak
> mocha oak

Montants

> chêne naturel
> chêne moka

Pfosten

> Eiche Natur
> Eiche Mokka

Estantes

> roble natural
> roble mocha

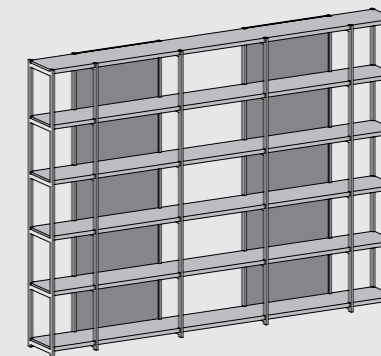
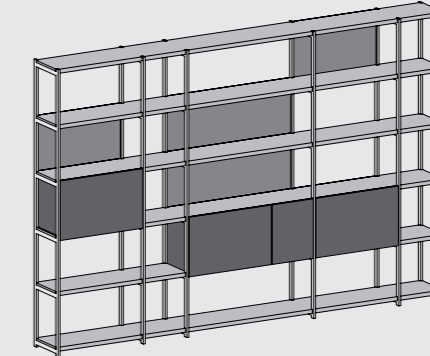
Esempidi composizioneExamplesof compositionExemplesde compositionBeispielevon KompositionEjemplosde composiciónProfondità

> 32 cm

Depth

> 32 cm / 12.6"

Profondeur

> 32 cm

Tiefe

> 32 cm

Profundidad

> 32 cm

Altezza

> 198 cm

Height

> 198 cm / 78.0"

Hauteur

> 198 cm

Hohe

> 198 cm

Altura

> 198 cm

Modularità

La libreria può avere infinite combinazioni considerando i seguenti moduli:

> 16 cm
> 32 cm
> 64 cm
> 80 cm
> 96 cm

Modularity

The library can have endless combinations considering the following modules:

16 cm / 6.3"
32 cm / 12.6"
64 cm / 25.2"
80 cm / 31.5"
96 cm / 37.8"

Modularité

La bibliothèque peut avoir multiple combinaisons en utilisant les modules suivants:

> 16 cm
> 32 cm
> 64 cm
> 80 cm
> 96 cm

Modulbauweise

Das Bücherregal kann viele Kombinationen haben, wenn man die folgenden Module betrachtet:

> 16 cm
> 32 cm
> 64 cm
> 80 cm
> 96 cm

Modularidad

La biblioteca puede tener múltiples combinaciones utilizando los siguientes módulos:

> 16 cm
> 32 cm
> 64 cm
> 80 cm
> 96 cm

Per maggiori informazioni vedere listino

For more info, please see price list

Pour plus d'informations, voir la liste des prix.

Weitere Infos in der Preisliste

Para más información, consulte la tarifa.

<p><u>Scocca</u></p> <p>› laccato lucido o laccato opaco nero bianco polvere beige rosso vino bruno grafite</p> <p>› faggio moca › faggio imbiancato › faggio bois blond</p>	<p><u>Body</u></p> <p>› glossy lacquered or matt lacquered black white dusty grey beige grey wine red brown grey graphite</p> <p>› mocha beech › whitened beech › bois blond beech</p>	<p><u>Corps</u></p> <p>› laqué brillant ou laqué mat noir blanc gris poussière gris beige rouge vin gris brun graphite</p> <p>› hêtre moka › hêtre blanchi › hêtre bois blond</p>	<p><u>Korpus</u></p> <p>› glänzend lackiert oder matt lackiert Schwarz Weiß Staubgrau Beigegrau Weinrot Braungrau Graphit</p> <p>› Buche Mokka › Buche geweißt › Buche Bois Blond</p>	<p><u>Cuerpo</u></p> <p>› lacado brillante o lacado opaco negro blanco gris polvo gris beige rojo vino gris parduzco grafito</p> <p>› haya moca › haya blanqueada › haya bois blond</p>
<p><u>Ante</u></p> <p>› laccato lucido o laccato opaco nero bianco polvere beige rosso vino bruno grafite</p>	<p><u>Doors</u></p> <p>› glossy lacquered or matt lacquered black white dusty grey beige grey wine red brown grey graphite</p>	<p><u>Portes</u></p> <p>› laqué brillant ou laqué mat noir blanc gris poussière gris beige rouge vin gris brun graphite</p>	<p><u>Türen</u></p> <p>› glänzend lackiert oder matt lackiert Schwarz Weiß Staubgrau Beigegrau Weinrot Braungrau Graphit</p>	<p><u>Puertas</u></p> <p>› lacado brillante o lacado opaco negro blanco gris polvo gris beige rojo vino gris parduzco grafito</p>
<p><u>Basamento obbligatorio</u></p> <p>› MCM (H16 cm) › MD (H16 / H32 cm)</p>	<p><u>Compulsory base</u></p> <p>› MCM (H16 cm) › MD (H16 / H32 cm)</p>	<p><u>Pieds obligatoires</u></p> <p>› MCM (H16 cm) › MD (H16 / H32 cm)</p>	<p><u>Obligatorische Basis</u></p> <p>› MCM (H16 cm) › MD (H16 / H32 cm)</p>	<p><u>Patas obligatorias</u></p> <p>› MCM (H16 cm) › MD (H16 / H32 cm)</p>
<p><u>Optional</u></p> <p>› ripiani in legno</p>	<p><u>Optional</u></p> <p>› wooden shelves</p>	<p><u>Optionnel</u></p> <p>› étagères en bois</p>	<p><u>Optional</u></p> <p>› Holzregale</p>	<p><u>Opcional</u></p> <p>› baldas de madera</p>
<p><u>Nota</u></p> <p>Di serie ripiani in vetro temperato.</p>	<p><u>Notice</u></p> <p>Tempered glass shelves as standard.</p>	<p><u>Avertissement</u></p> <p>Étagères en verre trempé en standard.</p>	<p><u>Anmerkungen</u></p> <p>Standard Temperglasregale.</p>	<p><u>Aviso</u></p> <p>Baldas de vidrio templado de serie.</p>

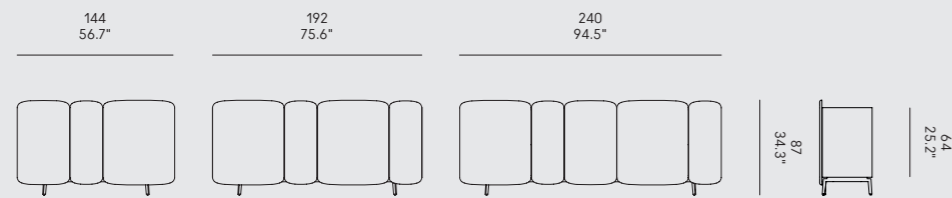

Profondità
› 49 cm

Depth
› 49 cm / 19.3"

Profondeur
› 49 cm

Tiefe
› 49 cm

Profundidad
› 49 cm

<p><u>Finitura</u></p> <p>› legno nero-bianco e alluminio finitura specchio</p>	<p><u>Finish</u></p> <p>› black-white wood and aluminium mirror finish</p>	<p><u>Finition</u></p> <p>› bois noir-blanc et aluminium brillant</p>	<p><u>Ausführung</u></p> <p>› Schwarz-weiß Holz und Aluminium- Spiegelung</p>	<p><u>Acabado</u></p> <p>› madera negro-blanco y acabado de aluminio espejo</p>
<p><u>Note</u></p> <p>Con più moduli singoli è possibile creare un sistema parete continuo. Il fianco della libreria, di mezza profondità rispetto alle mensole, permette di accostare più moduli senza raddoppiare lo spessore dei fianchi.</p>	<p><u>Notice</u></p> <p>By adding single modules, it is possible to create a continuous wall system. The sides, which are half the depth of the shelves, make it possible to put several modules side by side without doubling the width of the sides.</p>	<p><u>Avertissement</u></p> <p>Avec plusieurs modules simples, il est possible de créer un système de paroi continue. Le côté, d'une profondeur moyenne par rapport aux étagères, permet de placer plusieurs modules sans doubler l'épaisseur des côtés.</p>	<p><u>Anmerkungen</u></p> <p>Mit mehreren Einzelmodulen kann ein durchlaufendes Wandsystem zusammengestellt werden. Die Seite von halber Tiefe im Vergleich zum Regal ermöglicht das Aneinanderstellen mehrerer Module, ohne die Stärke der Seiten zu verdoppeln.</p>	<p><u>Aviso</u></p> <p>Con varios módulos individuales se puede crear un sistema mural continuo. El lado, de media profundidad con respecto a las repisas, permite colocar juntos más módulos sin duplicar el espesor de los lados.</p>

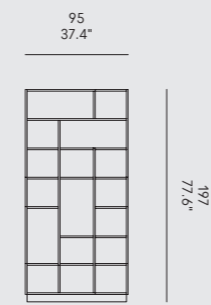

Profondità
› 26 cm

Depth
› 26 cm / 10.2"

Profondeur
› 26 cm

Tiefe
› 26 cm

Profundidad
› 26 cm

<u>Finitura</u> > laccato lucido o laccato opaco nero bianco polvere beige rosso vino bruno grafite	<u>Finish</u> > glossy lacquered or matt lacquered black white dusty grey beige grey wine red brown grey graphite	<u>Finition</u> > laqué brillant ou laqué mat noir blanc gris poussière gris beige rouge vin gris brun graphite	<u>Ausführung</u> > glänzend lackiert oder matt lackiert Schwarz Weiß Staubgrau Beigegrau Weinrot Braungrau Graphit	<u>Acabado</u> > lacado brillante o lacado opaco negro blanco gris polvo gris beige rojo vino gris parduzco grafito
<u>Fianco cassette</u> > alluminio	<u>Drawer sides</u> > aluminium	<u>Côté des tiroirs</u> > aluminium	<u>Schubladenseite</u> > Aluminium	<u>Laterales de cajones</u> > aluminio
<u>Basamento obbligatorio</u> > MCM (H16 cm) > MD (H16 / H32 cm)	<u>Compulsory base</u> > MCM (H16 cm) > MD (H16 / H32 cm)	<u>Pieds obligatoires</u> > MCM (H16 cm) > MD (H16 / H32 cm)	<u>Obligatorische Basis</u> > MCM (H16 cm) > MD (H16 / H32 cm)	<u>Patas obligatorias</u> > MCM (H16 cm) > MD (H16 / H32 cm)

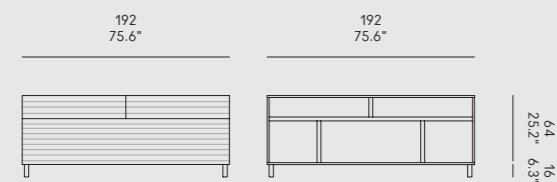

<u>Profondità</u> > 60 cm	<u>Depth</u> > 60 cm / 23.6"	<u>Profondeur</u> > 60 cm	<u>Tiefe</u> > 60 cm	<u>Profundidad</u> > 60 cm
------------------------------	---------------------------------	------------------------------	-------------------------	-------------------------------

<u>Finitura</u> > laccato lucido o laccato opaco nero bianco polvere beige rosso vino bruno grafite	<u>Finish</u> > glossy lacquered or matt lacquered black white dusty grey beige grey wine red brown grey graphite	<u>Finition</u> > laqué brillant ou laqué mat noir blanc gris poussière gris beige rouge vin gris brun graphite	<u>Ausführung</u> > glänzend lackiert oder matt lackiert Schwarz Weiß Staubgrau Beigegrau Weinrot Braungrau Graphit	<u>Acabado</u> > lacado brillante o lacado opaco negro blanco gris polvo gris beige rojo vino gris parduzco grafito
<u>Fianco cassette</u> > alluminio	<u>Drawer sides</u> > aluminium	<u>Côté des tiroirs</u> > aluminium	<u>Schubladenseite</u> > Aluminium	<u>Laterales de cajones</u> > aluminio
<u>Optional</u> > basamenti MCM (H16 cm) MD (H16 / H32 cm)	<u>Optional</u> > metal bases MCM (H16 cm) MD (H16 / H32 cm)	<u>Optionnel</u> > pieds métalliques MCM (H16 cm) MD (H16 / H32 cm)	<u>Optional</u> > Metallbasis MCM (H16 cm) MD (H16 / H32 cm)	<u>Opcional</u> > patas metálicas MCM (H16 cm) MD (H16 / H32 cm)
<u>Nota</u> Di serie piedini H2 cm regolabili.	<u>Notice</u> Adjustable H2 cm feet as standard.	<u>Avertissement</u> Pieds réglables H2 cm en standard.	<u>Anmerkungen</u> Regulierbare Standardfüße H2cm.	<u>Aviso</u> Pies regulables de H2 cm de serie.

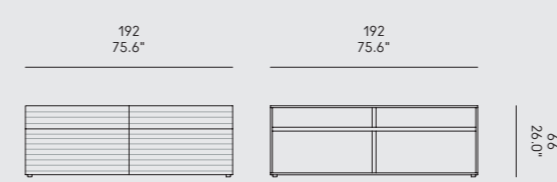

<u>Profondità</u> > 60 cm	<u>Depth</u> > 60 cm / 23.6"	<u>Profondeur</u> > 60 cm	<u>Tiefe</u> > 60 cm	<u>Profundidad</u> > 60 cm
------------------------------	---------------------------------	------------------------------	-------------------------	-------------------------------

Finitura › polietilene nero bianco polvere beige	Finish › polyethylene black white dusty grey beige grey	Finition › polyéthylène noir blanc gris poussière gris beige	Ausführung › Polyethylen Schwarz Weiß Staubgrau Beigegrau	Acabado › polietileno negro blanco gris polvo gris beige
--	---	--	---	--

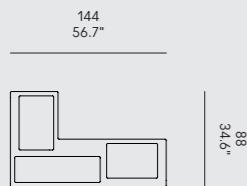

Profondità › 35 cm	Depth › 35 cm / 13.8"	Profondeur › 35 cm	Tiefe › 35 cm	Profundidad › 35 cm
------------------------------	---------------------------------	------------------------------	-------------------------	-------------------------------

Valises

Finitura › cuoietto sfumature di blu sfumature di verde sfumature di beige multicolor	Finish › hard leather grade 2 nuances of blue nuances of green nuances of beige multicolor	Finition › cuir nuances de bleu nuances de vert nuances de beige multicolor	Ausführung › Kernleder Blautöne Grüntöne Beigetöne Multicolor	Acabado › cuero tonos de azul tonos de verde tonos de beige multicolor
---	--	---	---	--

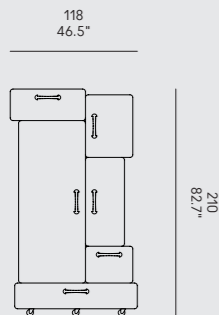

Profondità › 70 cm	Depth › 70 cm / 27.6"	Profondeur › 70 cm	Tiefe › 70 cm	Profundidad › 70 cm
------------------------------	---------------------------------	------------------------------	-------------------------	-------------------------------

Web Stopper

Finitura › alluminio verniciato nero bianco polvere beige	Finish › painted aluminium black white dusty grey beige grey	Finition › aluminium verni noir blanc gris poussière gris beige	Ausführung › beschichtetes Aluminium Schwarz Weiß Staubgrau Beigegrau	Acabado › aluminio pintado negro blanco gris polvo gris beige
---	--	---	---	---

Fermalibri › metallo zincato	Bookends › galvanized metal	Serre-livres › métal galvanisé	Buchstopper › verzinktes Metall	Sujetalibros › metal galvanizado
--	---------------------------------------	--	---	--

Nota Su richiesta le mensole possono essere accorciate su misura	Notice On request the shelves can be shortened to measure.	Avertissement Sur demande, les étagères peuvent être raccourcies sur mesure.	Anmerkungen Auf Wunsch können die Regale nach Maß gekürzt werden.	Aviso A petición, los estantes se pueden acortar a medida.
--	--	--	---	--



Profondità › 23 cm	Depth › 23 cm / 9.1"	Profondeur › 23 cm	Tiefe › 23 cm	Profundidad › 23 cm
------------------------------	--------------------------------	------------------------------	-------------------------	-------------------------------

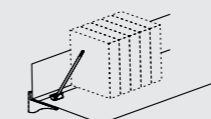

Fermalibri	Bookends	Serre-livres	Buchstopper	Sujetalibros
-------------------	-----------------	---------------------	--------------------	---------------------

<u>Montanti</u> > alluminio spazzolato bianco	<u>Uprights</u> > aluminium brushed white	<u>Montants</u> > aluminium brossé blanc	<u>Pfosten</u> > Aluminium gebürstet Weiß	<u>Montantes</u> > aluminio cepillado blanco
<u>Piedini e supporti</u> > plastica grigio bianco	<u>Feet and supports</u> > plastic grey white	<u>Pieds et supports</u> > plastique gris blanc	<u>Füße und Stützen</u> > Kunststoff Grau Weiß	<u>Pies y soportes</u> > plástico gris blanco
<u>Ripiani</u> > melaminico bianco > metallo grigio bianco	<u>Shelves</u> > melamine white > metal grey white	<u>Étagères</u> > mélamine blanc > métal gris blanc	<u>Einlegenböden</u> > Melamin Weiß > Metall Grau Weiß	<u>Estantes</u> > melamina blanco > metal gris blanco
<u>Contenitori</u> > melaminico bianco	<u>Cabinets</u> > melamine white	<u>Muebles de rangement</u> > mélamine blanc	<u>Behälter</u> > Melamin Weiß	<u>Contenedores</u> > melamina blanco
<u>Nota</u> La scaffalatura offre due tipi di montaggio: > pavimento-soffitto > pavimento-parete	<u>Notice</u> The rack offers two types of assembly: > floor-to-ceiling > floor-to-wall	<u>Avertissement</u> Le rack offre deux types de montage: > plafon-plancher > mur-plancher	<u>Anmerkungen</u> Das Gestell bietet zwei Montagearten: > Boden-Decke > Boden-Wand	<u>Aviso</u> La estantería ofrece dos tipos de montaje: > suelo-techo > suelo-pared

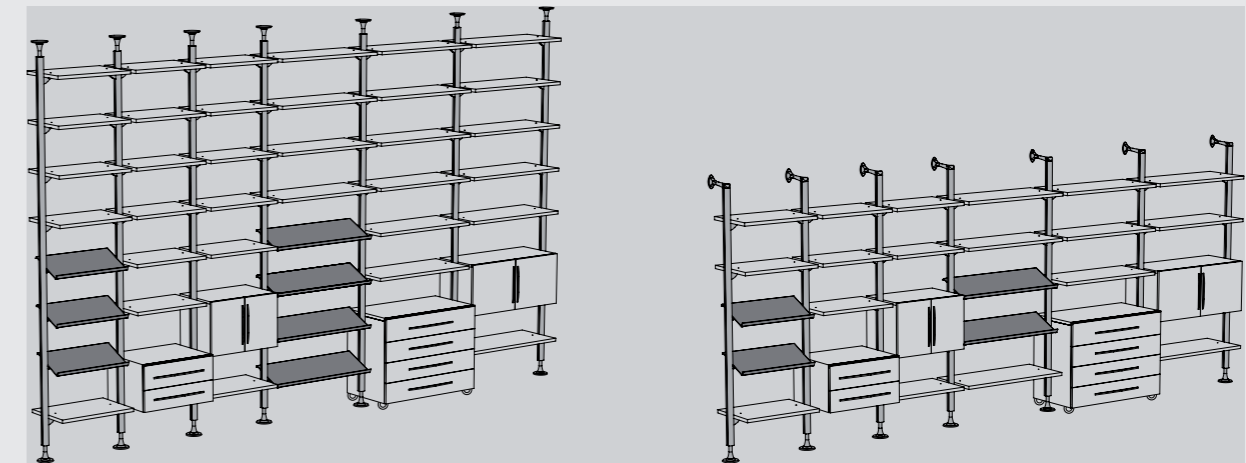

<u>Profondità ripiani</u> > 30 cm > 42 cm	<u>Shelves depth</u> > 30 cm > 42 cm	<u>Profondeur des étagères</u> > 30 cm > 42 cm	<u>Einlegenböden Tiefe</u> > 30 cm > 42 cm	<u>Profundidad estantes</u> > 30 cm > 42 cm
<u>Profondità contenitori</u> > 50 cm	<u>Storage units depth</u> > 50 cm	<u>Profondeur des meubles de rangement</u> > 50 cm	<u>Behälter Tiefe</u> > 50 cm	<u>Profundidad contenedores</u> > 50 cm
<u>Altezza</u> > fino a 400 cm	<u>Height</u> > up to 400 cm	<u>Hauteur</u> > jusqu'à 400 cm	<u>Hohe</u> > bis zu 400 cm	<u>Altura</u> > hasta 400 cm
<u>Modularità</u> La libreria può avere infinite combinazioni considerando i seguenti moduli: > 62 cm > 92 cm	<u>Modularity</u> The library can have endless combinations considering the following modules: > 62 cm > 92 cm	<u>Modularité</u> La bibliothèque peut avoir multiple combinaisons en utilisant les modules suivants: > 62 cm > 92 cm	<u>Modulbauweise</u> Das Bücherregal kann viele Kombinationen haben, wenn man die folgenden Module betrachtet: > 62 cm > 92 cm	<u>Modularidad</u> La biblioteca puede tener múltiples combinaciones utilizando los siguientes módulos: > 62 cm > 92 cm
Per maggiori informazioni vedere listino.	For more info, please see price list.	Pour plus d'informations, voir la liste des prix.	Weitere Infos in der Preisliste.	Para más información, consulte la tarifa.

Art Director

Renato Zamberlan

PhotosGianni Antoniali
/ Ikon ProductionsSet DresserClaudia Sani
/ Ikon Productionsexcept:Casamania image bank
78, 79, 82, 92, 94, 95,
102, 103, 104, 1045,
106, 107, 134, 135,
136, 137, 138, 139,
140, 141, 142, 143,
144, 145, 146, 147,
148, 149, 150, 151Thanks to:Bosa Ceramiche
Cc-tapis
London ArtHorm, Casamania and Orizzonti Italia
are registered trademarks of:Horm Italia Srlvia Antonio Carpenè, 17
33070 Brugnera (PN)
ItalyInternational
Sales Desk
orders@horm.it
Tel. +39 0434 1979101Ufficio Commerciale
Italia
ordini@horm.it
Tel. +39 0434 1979102horm.it
casamania.it
orizzontiitalia.it#HormDesign
#Casamania
#HormCasamania

© Horm Italia Srl

Tutti i prodotti illustrati
in questo catalogo sono
Made in ItalyAll products illustrated
in this catalogue are
Made in ItalyTous les produits
illustrés dans
ce catalogue sont
Made in ItalyAlle produkte in
diesem katalog sind
Made in ItalyTodos los productos
presentados en este
catálogo son
Made in Italy

Horm Italia Srl si riserva la facoltà di apportare, in qualunque momento e senza preavviso, modifiche e/o migliorie di carattere tecnico o estetico ai prodotti illustrati nel presente catalogo e declina ogni responsabilità per eventuali inesattezze contenute nello stesso. Le textures ed i colori dei materiali e delle finiture hanno valore indicativo in quanto soggetti alle tolleranze dei processi di stampa.

Horm Italia Srl reserves the right to make, at any time and without notice, technical or aesthetic changes and/or improvements to the products illustrated in this catalogue and declines all responsibility for any inaccuracies contained in it. Textures and colours of materials and finishes are indicative as they are subject to the tolerances of printing processes.

Horm Italia Srl se réserve le droit d'apporter, à tout moment et sans notification préalable, des modifications et/ou des améliorations de type technique ou esthétique aux produits illustrés dans le présent catalogue, et décline toute responsabilité pour les éventuelles inexactitudes contenues dans ce catalogue. Les textures et les couleurs des matériaux et des finitions sont une valeur indicative parce-que ils changent selon la tolérance aux procédés d'imprimerie.

Horm Italia Srl behält sich das Recht vor, jederzeit und ohne vorherige, Ankündigung Änderungen und/oder technische oder ästhetische Verbesserungen an den im vorliegenden Katalog dargestellten Produkten vorzunehmen, und übernimmt keine Verantwortung für eventuelle darin enthaltene Ungenauigkeiten. Die Texturen und Farben der Materialien und Finish haben einen indicativen Wert, da sie von den Toleranzen im Druckprozess abhängig sind.

Horm Italia Srl se reserva la facultad de aportar, en cualquier momento y sin previo aviso, cambios y mejoras de carácter técnico o estético a los productos ilustrados en este catálogo, y se exime de toda responsabilidad por cualesquiera inexactitudes que éste catálogo pueda contener. Las textures y los colores de los materiales y de los acabados tienen solo un valor indicativo porque están sujetos a la tolerancia de los procesos de imprenta.

